



International Conference



**On
Futuristic Trends in Engineering, Science,
Humanities, and Technology
FTESHT-16**

January 23 – 24, 2016

VOLUME-2

Editors

Dr. P.S. Chauhan

Convener, FTESHT-2016

Dr. Ravi K. Dwivedi

Conference Secretary, FTESHT-2016

Organised by

IPS College of Technology & Management
Gwalior, Madhya Pradesh (India)

in

Association with

TRO INDIA

Preface

It gives us immense pleasure to present the proceeding of the International Conference on Futuristic Trends in Engineering, Science, Humanities, and Technology (FTESHT-2016) to be held during January 23-24, 2016 in the IPS College of Technology & Management.

One of the major objectives of the present International Conference is to provide a platform for Scientists, Technocrats and Researchers to share and exchange views on the opportunity and challenges offered by the ever increasing technological advancement taking place in the world.

There has been excellent response from various sections which is evident from the contributions received through valuable articles. We sincerely acknowledge and express our gratitude to the reviewers for their great contribution in selecting the worthy articles and facilitating the process of publication.

We take this opportunity to thank International and National Advisory Committee members and reviewers for their guidance and timely help. We also appreciate the efforts of my colleagues, members of the staff and students to make this event successful. We hope that the proceedings gets your appreciation.

Place: Gwalior, M.P., India

Date: January 23, 2016

Dr. P. S. Chauhan

Convener

Dr. Ravi K. Dwivedi

Conference Secretary



Government of Madhya Pradesh
BHOPAL - 462 004
S.No. - 20, January 14, 2016

Shivraj Singh Chouhan

Chief Minister

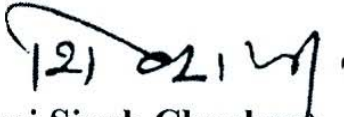
Message

I am delighted to know that IPS College of Technology and Management, Gwalior is organizing an international conference on Futuristic Trends in Engineering, Science, Humanities and Technology (FTESHT-2016).

Innovations in science and technology aiming at human welfare need encouragement. The State Government is promoting scientific temperament among the masses so that optimum benefits of scientific advancement could be harnessed in an enthusiastic fashion.

I hope the conference will be a grand success with the renowned professionals sharing their insights on the subject.

Regards.


(Shivraj Singh Chouhan)



Shri Anoop Mishra
Hon'ble Member of Parliament (Morena)
Government of India

January 12, 2016

Message

With the advent of new technologies, new avenues are opening up. Emergence of new Technology is also throwing up new challenges. In the context of the new challenges educational Institutions need to constantly review, update knowledge and adopt technology driven skills. This is possible through mutual exchange of thoughts and sharing of knowledge and skills.

I am quite sure that this International Conference on “Futuristic Trends in Engineering, Science, Humanities & Technology” will provide a unique opportunity of sharing and equipping trends and latest research works.

It is my heart-felt wish that this event becomes a successful forum of exchange of ideas and knowledge for one and all.

Regards.

Anoop Mishra



Prof. Piyush Trivedi
Vice Chancellor



राजीव गांधी प्रौद्योगिकी विश्वविद्यालय, म.प्र.
(मध्यप्रदेश का तकनीकी विश्वविद्यालय)

Rajiv Gandhi Proudyogiki Vishwavidyalaya, M.P.
(State Technological University of Madhya Pradesh)

DO Letter No. : vc/PS/2016/693

दिनांक / Date : 12/01/2016

MESSAGE


I am happy to learn that the **IPS College of Technology & Management, Gwalior** is organizing the International Conference on “**Futuristic Trends in Engineering, Science, Humanities & Technology (FTESHT-2016)**” on January 23-24, 2016.

I hope this International Conference will provide an excellent platform for developmental and research activities in the field of Science, Humanities and Engineering.

I am sure that deliberations made by the experts will be beneficial for advancement of science and technology.

It is a laudable effort of the organizers for choosing a very relevant and active field of research. Conducting the Conference as above, are vital part of quality improvement activities for all the stake holders viz a viz researchers, faculty, academecia and Students community.

I extend my warm greetings to the organizers and hope that the Conference will attain its desired goals.


Prof. Piyush Trivedi 12/01/16



Smt. Shobha Mishra
Chairperson
IPS Group of Colleges

January 11, 2016

Message

“Vision looks inward & becomes duty

Vision looks outward & becomes aspiration

Vision looks upward & becomes faith”

When the vision of duty, aspiration and faith become a reality, it becomes a proud moment for me and my team to see professionals, students and researchers come together to work collectively towards a better society.

The International Conference on “Futuristic Trends in Engineering, Science, Humanities & Technology” is being organized with a view to provide a platform to the professionals, scientists and students to work together for a just and better society.

I extend warm greetings to all those associated with the conference and wish the conference a grand success.

Shobha Mishra



Dr. Arun K. Tyagi
Director
IPS Group of Colleges

January 11, 2016

Message

Education is simply the soul of the society as it passes from one to another.

G.K. Chesterton

The world is moving very fast & new technologies are coming every week. We need to be proactive & enthusiastic in learning about these cutting edge tools and research.

New technology is bringing opportunities along with new set of skills and new challenges. Interaction in person is the best mode of communication to know the development taking place in Science, Technology & Engineering.

IPS constantly strives to meet challenges of future by fostering education and technical advancement. This conference is an effort in the similar direction. It aims at keeping pace with technological development taking place globally and bridging the technology gaps.

I am quite optimistic about the success of the conference and wish it gives a qualitative outcome for global educational growth and development.

Best wishes....!!!

Dr. Arun K. Tyagi



Mr. Ashwini Mishra
Deputy Director
IPS Group of Colleges

January 11, 2016

Message

I am delighted to know that the IPS is organizing an International Conference on “Futuristic Trends in Engineering, Science, Humanities & Technology.”

Knowledge is a liberating force which helps in removing the barriers of prejudices and ignorance and facilitates eliminating the various disparities between human beings. Knowledge has also come a long way, from being power to becoming powerful vision.

I am sure this conference will prove a step-ahead in the same direction and achieve the ultimate target of global academic success.

I offer my best wishes and greetings to all the participants and wish good luck and grand success.

Ashwini Mishra



Mr. P. K. Ghosh
CAO
IPS Group of Colleges

January 11, 2016

Message

It is a matter of great happiness for me to know about the initiative being taken by the teaching community and students of IPS College of Technology & Management for having conceived and organize an International Conference.

The theme of the International Conference is appropriate in the present context. I am sure the conference will bring Engineers, Technocrats and Professional on a common platform, for exchange of views and sharing updated knowledge which will go a long way as a value addition to the education system.

I wish the organizers and participants the very best in their endeavor and am confident that the event will be a great success.

I extend my sincere greetings.

P. K. Ghosh

International Advisory Committee

Dr. M. Rahman, Professor, National University of Singapore
Dr. Madhavi Singh, Penn State Hershey Medical Group Park Avenue, USA
Dr. Dariusz Jacek Jakóbczak, Professor, Technical University of Koszalin, Poland
Dr. Khalid Mahmoud Abd Elghany, Director of CAD/CAE and RPM Lab, CMRDI, Egypt

National Advisory Committee

Dr. V. K. Jain, Professor, IIT Kanpur
Dr. Rabi Pradhan, Associate Professor, IIT Kharagpur
Dr. Uday S. Dixit, Associate Professor & Head, IIT Guwahati
Dr. R. S. Jadon, Professor, G. B. Pant University, Pant Nagar
Dr. Manpreet Singh Manna, Director, AICTE, New Delhi
Mr. Alok Mathur, General Manager- Production, JK Tyre, Banmore
Dr. A. Lakshmi Devi, Professor, SVU College of Engineering, Sri Venkateswara University
Prof. Shravani Badiganchala, Shirdi Sai Institute of Science and Engineering
Dr. Bhasker Gupta, Jaypee University of Information Technology, Himachal Pradesh, India
Prof Amit R. Wasnik, Sinhgad Institute of Technology, Lonavala, Pune Maharashtra (SIES Group)
Prof. M. K. Sharma Amrapali Institute, Haldwani
Dr. Arjun Pralhad Ghatule, Sinhgad Institute of Computer Sciences (SICS), Korti
Prof. Abhay Saxena Sanskrit Vishavvidyalaya, Haridwar
Dr. G.Suresh Babu, Professor, CBIT, Hyderabad, Andhra Pradesh
Prof. Sanjay Ramchandra Kumbhar, Rajarambapu Institute of Technology, Rajaramnagar, Maharashtra
Dr. Punyaban Patel, Chhatrapati Shivaji Institute of Technology, Durg
Prof. Dipak S.Bajaj, Amrutvahini College of Engineering, Sangamner
Dr. Rajeev Agrawal, Birla Institute of Technology (Deemed University), Ranchi, Jharkhand
Dr. Hansa Jeswani, Sardar Patel College of Engineering, Mumbai, Maharashtra
Dr. S. P. Anandaraj, Sr. Asst. Professor, Dept. of Computer Science, SR Engineering College
Dr. Chandrakant R. Sonawane, Dyanganga College of Engineering & Research, Pune
Prof. Deepika Vodnala, Assistant Professor, SREC, Warangal
Prof. Subzar Ahmed Bhat, Assistant Professor, GLA University
Mr. I. Hameem Shanavas, Department of ECE, M.V.J College of Engineering, Bangalore
Mr. K. Maheshkumar, Bannariamman Institute of Technology, Sathy
Mr. B. Sudheer Kumar, Placement Officer, Vaagdevi Institute of Technology & Science
Mr. Krishna Nand Pandey, Galgotias College of Engineering & Technology, Greater Noida
Mr. Vishal J. Deshbhratar, Assistant Professor, ITM COE, Kamptee, Nagpur
Mr. Ram Indrajit Chavan, BITS Pilani, K. K. Birla Goa Campus, Goa
Mr. Sanjith J, P.G. Coordinator, Adhichunchanagiri Institute of Technology, Karnataka
Mr. Jeetendra Bhawsar, Medi-Caps Institution of Technology and Management, Indore

Organizing Committee

Patrons

Mrs. Shobha Mishra

Dr. Arun K. Tyagi

Mr. Ashwani Mishra

Mr. P. K. Ghosh

Chairperson, IPS GOC

Director, IPS GOC

Deputy Director, IPS GOC

CAO, IPS GOC

Convener

Dr. P.S. Chauhan

Principal, IPS College of Technology &
Management

Secretary

Dr. Jagat Mishra

Dr. R.K. Dwivedi

Director, TRO India

Associate Professor, MANIT, Bhopal

Reception Committee

Dr. Atul Kaushik

Dr. Rama Tyagi

Dr. P.S. Chauhan

Dr. Ashutosh Trivedi

Prof. Ramesh Kumar Batra

Prof. V. K. Jain

Dr. Jyoti Mishra

Prof. Anurag Garg

Prof. Karunendra Verma

Prof. Alok Pathak

Prof. Anil Singh

Prof. Rajeev Shrivastava

Principal, IPS College of Pharmacy

Principal, Institute of Professional Studies

Principal, IPS College of Technology & Mgmt

Dean, Research & Development

Head, Dept. of Civil Engineering

Head, Dept. of Mechanical Engineering

Head, Dept. of Applied Sciences & Humanities

Head, Dept. of Electronics & Comm. Engineering

Head, Dept. of Computer Science & Engineering

Head, Dept. of Electrical Engineering

Head, Dept. of Management

Head, Dept. of Finishing School

Conference Coordinators

Mr. Anurag Garg

Mr. R.P. Singh

Mr. Karunendra Verma

Mr. Pankaj Agrawal

Mr. Sumit Tiwari

Dr. Rajiv Dwivedi

Mr. Ramani Ranjan Pandey

Mr. Santosh Mukerjee

Head, Dept. of Electronics & Comm. Engineering

Faculty, Dept. of Mechanical Engineering

Head, Dept. of Computer Science & Engineering

Faculty, Dept. of Electronics & Comm. Engineering

Faculty, Dept. of Computer Science & Engineering

Faculty, Dept. of Applied Sciences & Humanities

Junior Engineer, NSPCL

Manager, TROINDIA

Functional Committees

Sr. No	Committee	Faculty Members
1	Registration Committee	Mr. Karunendra Verma (Coordinator) Mrs. Ritika Keswani Ms. Arti Vig
2	Welcome Committee	Mrs. Anupma Agrawal (Coordinator) Mr. Anurag Garg Mr. Sumit Tiwari Ms. Deepti Bhargava
3	Accommodation Committee	Mr. Pankaj Goyal (Coordinator) Mr. R. P. Singh Mr. Anand Bhatnagar Mr. Prabhu Dayal Mr. Maheshwari Prasad
4	Technical Session Committee	Mr. V.K. Jain (Coordinator) Mr. R. K. Batra Dr. Jyoti Mishra Mr. Anurag Garg Mr. Karunendra Verma Mr. Alok Pathak
5	Printing & Publication Committee	Mr. Pankaj Goyal (Coordinator) Mr. Shatrughan Mishra Mr. Ganesh P. S. Jadon Mr. Suresh Dixit
6	Logistics Committee (Venue)	Mr. Shatrughan Mishra (Coordinator) Mr. Juber Qureshi Mr. Ashutosh Bansal Mr. Hitendra Parhak
7	Food & Refreshment Committee	Mr. Sourabh Agrawal (Coordinator) Mr. Akash Agrawal Mr. Ravi Chourasia
8	Transportation Committee	Mr. Pankaj Goyal (Coordinator) Mr. Sumit Nigam Mr. Manvendra Gautam Mr. Maheshwari Prasad
9	Cultural Committee	Mr. Sudhir Sharma (Coordinator) Mrs. Anupama Agrawal Ms. Deepti Bhargava
10	Certification Committee	Dr. Rajeev Dwivedi (Coordinator) Mr. Manoj Sharma Mr. Sumit Pathak Mrs. Mukta Shrivastava
11	Invitation Committee	Dr. Jyoti Mishra (Coordinator) Dr. Snehika Shrivastava Dr. Alka Pradhan Mrs. Anupama Agrawal

12	Electrical Power Supply Committee	Mr. Alok Pathak (Coordinator) Mr. Sanjay Kulshreshtha Mr. Neeraj Pandey
13	Videography & Photography Committee	Mr. Ranjeet P. Singh (Coordinator) Mr. Suresh Dixit
14	Flex designing Committee	Mr. Kapil Keshwani (Coordinator) Mr. Vineet Raj Singh Kushwah Mr. Manvendra Gautam

For any assistance or clarification, contact Dr. P.S. Chauhan, Convener of this event.

Dr. Arun K. Tyagi

Patron – FTESHT 2016,
IPS College of Technology & Management,
Shivpuri Link Road, Gwalior,
Madhya Pradesh – India 474001

TABLE OF CONTENTS

SL NO	TITLE/AUTHOR	PAGE NO
1.	SYNTHESIS, CHARACTERIZATION AND BIOLOGICAL ACTIVITIES OF TRANSITION METAL COMPLEXES DERIVED FROM S-ALKYL DITHIOCARBAZATE - Snehika Shrivastava, Mukta Srivastava	01-05
2.	ASSOCIATION RULE MINING: A DATA PROFILING AND PROSPECTIVE APPROACH - Hemant Kumar Soni, Sanjiv Sharma, Pankaj K. Mishra	06-09
3.	BENEFITS OF SOFTWARE REUSE - T.Rajani Devi, B.Rama	10-14
4.	VIBRATION ANALYSIS OF FUNCTIONALLY GRADED PLATES WITH MULTIPLE CIRCULAR CUTOUTS - Avadesh K Sharma, Premanand S. Chauhan , Manoj Narwaria, Rajkumar Pankaj	15-21
5.	SENSE OF PLACE IN AMITAV GHOSH'S THE HUNGRY TIDE: A CRITIQUE - Rekha Shukla, B.K. Sharma	22-24
6.	EXPERIMENTAL INVESTIGATION OF 4 STROKE COMPRESSION IGNITION ENGINE BY USING DIESEL AND PROCESSED WASTE COOKING OIL BLEND - Neelesh Soni, Om Prakash Chaurasia	25-29
7.	DEVELOPMENT OF MULTIBAND ANTENNA USING METAMATERIAL - Sumit Nigam, Ashutosh Sharma	30-33
8.	EFFECTS OF GENDER ON THE PRODUCTION OF VOWEL DURATION IN YEMENI ARABIC DIALECTS: AN ACOUSTIC STUDY - Aisha Saleh Ali Mohdar	34-37
9.	ANALYSIS OF MOISTURE SENSOR BASED ON MICROSTRIP PATCH ANTENNA: A REVIEW - Sweety Jain, Pankaj Kumar Mishra, Vandana Vikas Thakare	38-41
10.	REVIEW ON LEASE SCHEDULING IN HAIZEA FOR IAAS CLOUD - Aarti Vig, Ritika Keswani	42-46

11. REVIEW OF SUPERCRITICAL FLUID WITH DESUPERHEATER ON RANKINE CYCLE FOR THERMAL POWER PLANTS	
- Mayur Sen	47-50
12. MANAGEMENT OF ENERGY & WASTE AND SUSTAINABLE ENVIRONMENT IN SHOPPING MALLS – AN EMPIRICAL STUDY	
- Abhishek Jain, Prabhu Dayal Arya,Ashutosh Bansal	51-57
13. SPEED CONTROL OF THREE PHASE INDUCTION MACHINE USING MATLAB	
- Maheshwari Prasad, Himmat singh, Hariom Sharma	58-62
14. ANALYSIS OF ELECTRICAL LOAD FORECASTING BY USING MATLAB TOOL BOX THROUGH ARTIFICIAL NEURAL NETWORK	
- Neeraj Pandey, Sanjay Kulshrestha, Manoj Kumar Saxena	63-69
15. DESIGN FAILURE MODE EFFECT ANALYSIS OF A CENTRIFUGAL OIL CLEANER AND PLAN FOR VALIDATION OF THE DFMEA	
- A.P.Shrotri, Satyjit Chitale, N.V.Hargude, G.S.Joshi, A.R.Dandekar	70-76
16. AUTOMATIC DETECTION OF ALZHEIMER DISEASE USING EEG MODULATION ENERGY	
- Alok Pathak	77-82
17. AN INNOVATIVE TECHNIQUE FOR ROAD CONSTRUCTION BY WASTE PLASTIC	
- Rahul Singh Yadav, R. K. Batra	83-86
18. APPLICATION OF THE ANALYTICAL HIERARCHY PROCESS (AHP) IN THE SELECTION OF CONTRACTORS/CONSULTANTS	
- Agraj Sharma, Ramesh Kumar Batra	87-93
19. HEAT TRANSFER ENHANCEMENT BY SWIRL FLOW DEVICES	
- Tarique Anwar Qureshi, Anil Singh Yadav	94-99
20. ANALYSIS OF LOOSE VIRTUAL CLUSTERING BASED ROUTING ALGORITHM FOR POWER HETEROGENEOUS MANETS	
- Vinod Mahor, Sadhana Bijrothiya	100-105
21. ANALYSIS OF VARIOUS CONTRAST IMPROVEMENT TECHNIQUES FOR DEHAZING AN IMAGE	
- Ashok Kumar Shrivastava	106-110
22. A SHORT REVIEW ON SOLAR WATER DISTILLATION FOR GETTING FRESH WATER IN RURAL AREA	
- Abhay Agrawal, R. S. Rana, P.K. Shrivastava ³ , R.P. Singh	111-120

23. ROLLING ELEMENT BEARING FAULT DETECTION THROUGH ADAPTIVE FILTERING WAVELET TRANSFORM USING VIBRATION & CURRENT SIGNALS	
- Gajendra Dubey, Rajiv Dwivedi	121-125
24. FEMALE EXPLOITATION: A STUDY OF MANJU KAPUR'S DIFFICULT DAUGHTERS	
- J.P. Singh, Rashmi Dwivedi	126-129
25. CHALLENGES WITH UNSTRUCTURED BIG DATA ANALYSIS USING MACHINE LEARNING APPROACH: A REVIEW	
- Devendra Kumar Mishra	130-133
26. COMPONENTS DESIGN OF HOISTING MECHANISM OF 5 TONNE EOT CRANE	
- Pooran Singh Dhakar, S.G.Mishra, K.C.Arora	134-138
27. DESIGN AND DEVELOPMENT OF ELECTRO-MAGNETIC SOLAR INTEGRATED SYSTEM ON HIGHWAYS	
- Burhan Pasha C S, Naseer Ahmed S N, Kiran T, Jamsheer P T	139-141
28. OPTIMIZATION OF SURFACE ROUGHNESS OF A DRILLED HOLE ON SUP 11A BY TAGUCHI'S OPTIMIZATION TECHNIQUE	
- Premanand S. Chauhan, Ravi K. Dwivedi, Sudhir Sharma	142-148
29. HIERARCHY IN POWER IN THE HISTORY OF CIVILIZATION: A CRITIQUE OF V.S. NAIPAUL'S TRAVELOGUE, INDIA A WOUNDED CIVILIZATION	
- Deepti Bhargava	149-152
30. AN APPROACH TO STUDY THE ATMOSPHERIC ELECTRIC FIELD USING EFM SYSTEM	
- Anupma Agarwal, Shourabh Bhattacharya	153-156
31. A MODEL TO STUDY CALCIUM DISTRIBUTION IN CARDIAC MYOCYTES	
- Sonia Shivhare	157-161
32. OPTIMIZATION OF WELDING PARAMETER FOR ARC WELDING OF MILD STEEL PLATE (GRADE-40)	
- Dharmendra Singh Jadoun, Rajendra Prasad Kori, Dinesh Kumar Kasdekar	162-165
33. A REVIEW STUDY ON DIGITAL WATERMARKING TECHNIQUES	
- Vineet Raj Singh Kushwah, Sumit Tiwari, Manvendra Gautam	166-170

34. **A REVIEW OF INNOVATIVE RURAL ROAD CONSTRUCTION TECHNIQUES**
- Deepak Tiwari, Manoj Sharma, A.S.Trivedi 171-176
35. **EFFECT OF RADIAL VISCOSITY VARIATION ON NON-NEWTONIAN
FLOW OF BLOOD IN AN OVERLAPPING STENOSED ARTERY**
- Pushkar Singh, Aditi Singh, S. P. Singh 177-183



Dr. Elammaraman Jayamani

Faculty of Engineering, Computing and Science
Swinburne University of Technology Sarawak
Campus Malaysia

E-mail: ejayamani@swinburne.edu.my

Phone: +60-16-5774867

January 23, 2016

KEYNOTE SPEECH

Green Manufacturing

Abstract

Green Manufacturing is a challenge for today but as business opportunities for tomorrow. This work presents the importance of Green manufacturing. This concept focuses on both how the product is made as well as the product's attributes. Nowadays customers are environment conscious and also the environmental protection is a top agenda for them. They are thinking about the global issues such as global warming, depletion of the Ozone layer, running out of fossile fuel supply and loss of trees and forest.

The detailed discussion of the intersection of the environment and manufacturing been discussed related to Green manufacturing, clean technologies and Green products, this work also covers things such as making products with less energy and materials, producing less waste, and fewer hazardous materials as well as products that have greener attributes.



Dr. Joydip Dhar (PhD-IITK)

Associate Professor

Department of Applied Sciences

ABV-Indian Institute of Information Technology and Mgmt

Gwalior-474010, M.P., India

E-mail: jdhar@iiitm.ac.in

Phone: +91-751-2449829

January 23, 2016

KEYNOTE SPEECH

Fundamentals of Mathematical Model Development for Basic Sciences

Abstract

The problems that modelers wish to solve exist in the real world. First step is to simplify the real world to create a model world, i.e., the model world leaves out much of the complexity of the real world problem. The original question gets translated into a question involving the model world. Next, we construct a model of the problem in the model world using known mathematical tools and techniques. The final step is to interpret the answer found for the model world problem back in the real world. “Every study must begin with a clear statement of the study’s overall objectives and specific issues to be addressed; without such a statement there is little hope for success”. Modeling is a way of thinking and reasoning about systems. The goal of modeling is to come up with a representation that is easy to use in describing systems in a mathematically consistent manner. Models based on good theory can compensate for lack of data, and models based on broad evidence can compensate for lack of theory, but models alone can hardly compensate for the lack of both. We often fail to realize how little we know about a thing until we attempt to simulate it on a computer.



Dr. Karmveer Arya

(M.Tech – IISc, Bangalore, PhD-IITK)

Associate Professor

ABV-Indian Institute of Information Technology and Mgmt
Gwalior-474010, M.P., India

E-mail: kvarya@iiitm.ac.in

Phone: +91-751-2449830

January 23, 2016

KEYNOTE SPEECH

Restoration from Noisy and Motion Blurred Images

Abstract

Generally the images captured in uncontrolled environment have degraded quality as compared to the original images due to imperfections in the imaging and capturing process. The degraded images are classified into two major categories: (i) blurred images and (ii) noisy images. The factors responsible for blurring of images in general are: atmospheric turbulence, defocusing of the lens, aberration in the optical systems, relative motion between the camera and scene. The restoration of such blurred images sometimes becomes mandatory particularly in surveillance applications. The effectiveness of the restoration process mainly depends on the blurring system model. The motion blur system is characterized by two parameters, namely, blur direction and blur length. Various methods for the identification of blur parameters have been proposed in literature. The popular methods used for determination of point spread function (PSF) parameters in the spectral domain will be discussed. The talk will focus on the algorithms to determine motion blur PSF parameters, i.e., blur direction and blur length, in frequency domain. The blur direction is identified using Hough transform to detect the orientation of line in the log magnitude spectrum of the blurred image. The blur length is found by rotating the binarized spectrum of the blurred image in the estimated direction. These parameters are used to restore the images. A modified Wiener filter is then employed for restoration of images.

SYNTHESIS, CHARACTERIZATION AND BIOLOGICAL ACTIVITIES OF TRANSITION METAL COMPLEXES DERIVED FROM S-ALKYL DITHIOCARBAZATE

Snehika Shrivastava¹, Mukta Srivastava²

¹Associate Professor, Department of Chemistry, IPS-CTM, Gwalior (M.P)

²Assistant Professor, Department of Chemistry, IPS-CTM, Gwalior (M.P)

Email: snehikashrivastav@gmail.com¹, muktaips@gmail.com²

Abstract

The Coordination compounds of Schiff base derived from S-alkyl dithiocarbamate with transition metal ions, viz, Cu(II), Mn(II) and Zn(II) have been prepared and characterized by infrared, ¹H NMR, UV-Vis, elemental analysis and conductivity measurement. The ligand S-methyl-β-N-(2-chlorobenzalidine) dithiocarbamate behaves as a mono and bidentate chelating agent and bonded to the metal ion through azomethine nitrogen and thiol sulphur atom of dithiocarbamate moiety. Electronic spectra and elemental analysis measurement reveal found to be non-electrolyte in nature on the basis of low value of molar conductance. All of the synthesized compounds are biologically active and screened for their antibacterial and antifungal activities which are found to exhibit moderate to significant biological activities.

Keywords: Synthesis, Schiff base, Complexes, Antibacterial and antifungal activity.

Introduction

Metal dithiocarbamate complexes involving nitrogen-sulphur donor ligands are of considerable interest due to their potential biological activity¹ and practical applications in the fields of pharmaceutical and agricultural industries^{2,3}, in addition to the general considerations of metal-nitrogen and metal-sulphur bonding and electron delocalisation in transition metal complexes. Dithiocarbamates exhibit significant anti-fungal, anti-protozoal, anti-bacterial and anti-cancer activity⁴⁻⁶. Recently, as in vitro insulinomimetic potential of these compounds has been established⁷. We report herein the synthesis and characterization of a new ligand having NS donor atoms and its complexes with Cu(II), Mn(II) and Zn(II) ions and describe their potential as anti-bacterial and anti-fungal agents.

Experimental

All the chemical and reagent used were of reagent grade and used without any further purification. The IR spectra of ligand and its complexes in DMSO were recorded on a Perkin-Elmer 283 spectrophotometer in the 4000-400cm⁻¹ region. Electronic absorption

spectra were obtained on a Spectrascan UV-2700, using a prepared dimethyl sulphoxide solution in the 200-1100 nm region. The ¹H NMR spectral analysis were performed on a Bruker advance 400 spectrophotometer using TMS as an internal standard.

Elemental analysis (N, S and Cl) of the ligand and complexes were carried out in Microanalytical laboratory, CDRI Lucknow on Elemental Vario EL III Carlo Erba 1108 elemental analyzer. Molar conductance measurements were carried out for the 10⁻³M solution of the complexes in DMF solvent at 298K using Decibel DB1011. Purity of the compounds was checked on TLC using silica gel-G. Melting points were determined in open capillaries and are uncorrected.

Synthesis of Ligand

A solution of s-methyl dithiocarbamate (0.1mol) in absolute ethanol (40cm³) was added to an equimolar solution of 2-chlorobenzaldehyde in 50 cm³ of the same solvent. The solution was heated on a steam bath for 2-3hrs and then cooled to 0°C in an ice bath. Precipitated Schiff

base were filtered, washed and recrystallized with ethanol and dried at room temperature.

M.P. 143°C. Yield 70%.

Anal.(%) Found: N,11.3; S, 26.0 %,

Calc for C₉H₉N₂ClS₂: N,11.5; S, 26.2 %.

General method for synthesis of Metal Complexes

The Schiff base (0.002mmol) and metal salt (0.001) Cu(OAc)₂.H₂O, CuCl₂, Mn(oAc)₂ and Zn(OAc)₂. was dissolved in ethanol (20 ml) and content were refluxed for 3-5hrs on water bath. The mixture was then cooled in an ice bath and the product were filtered with suction, washed with ethanol and dried in desiccator over anhydrous silica gel. The Coloured solid are obtained and are mostly soluble in common organic solvents, DMSO and DMF.

The physical properties, analytical and spectral data of ligand and their complexes are shown in Table 1 and 2.

Results and Discussion

The elemental analysis data of the ligand and its complexes are given in Table-1. The data indicates the formation of 1:1 [M:L] ratio of the formulae of [M(2cbsme)₂] [M = Cu²⁺] and 1:2 [M:L] ratio of the formulae of [M(pmasme)₂] [M = Cu²⁺, Mn²⁺ and Zn²⁺]. The molar

conductances of the complexes in DMF indicate that they are essentially non-electrolyte in this solvent. The non-electrolytic nature of the complexes indicates that the ligand is coordinated as a uninegatively charged anion that the chloride anions are also coordinated to copper (II) ions⁶ in formation of [M(L)Cl] whereas in case of [M(L)₂] anion being used (OAC)₂ is not coordinated with metal ions⁷.

The 2-cholorobenzaldehyde Schiff base of S-methyl dithiocarbazate has the -N(H)C(S) (thioamide) function and therefore, in principle, it can exhibit thione (Fig.1a) and thiol (Fig.1b) tautomerism. However, its IR Spectrum in KBr does not exhibit any ν(S-H) band at approximately 2700, but displays a medium intensity band at 2912cm⁻¹ attributable to the ν(N-H) of the thione form. This is strong evidence that, like other Schiff bases of S-alkyldithiocarbazates, it also remains as the thione tautomer in the solid state. But when it is dissolved in ethanol and a metal [Cu(II), Mn(II) and Zn(II)] salt is added to the solution, it quickly converts to the thiol form with the concomitant formation of a metal (II) complex of the deprotonated thiolate form of the Schiff base.

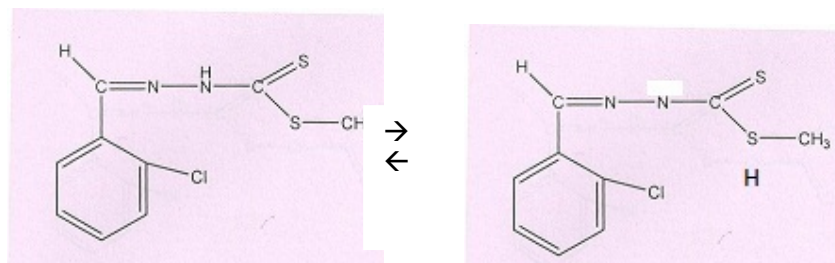


Fig.1. H2cbsme: (a) thione form and (b) thiol form.

Table 1

ANALYTICAL DATA AND PHYSICAL PROPERTIES OF THE SCHIFF BASE AND ITS COMPLEXES.

S.No.	Compounds ^a	Colour	Yield (%)	M.P. (°C)	Molar Conductance ^b	Analytical data ^c		
						N	Cl	S
2a.	H2cbsme	Yellow	70	156	-----	11.10 (11.02)		25.28 (25.20)

3a.	[Cu(2cbsme)Cl ₂]	Yellow	62	146	7.1	7.3 (7.4)	28.2 (28.5)	17.1 (16.9)
3b.	[Cu(2cbsme) ₂]	Brown	60	150	6.3	10.8 (10.2)	11.8 (12.9)	23.1 (23.3)
3c.	[Mn(2cbsme) ₂]	Light brown	67	148	4.2	10.8 (10.2)	11.8 (12.9)	23.1 (23.3)
3d.	[Zn(2cbsme) ₂]	Yellow	72.5	186	3.2	10.5 (10.1)	12.7 (12.9)	22.7 (23.2)

^aH₂cbsme anionic form of the Schiff base of S-methyldithiocarbazate with 2-chlorobenzaldehyde.

^bMolar conductance of approximately 10⁻³ M solutions in DMF (ohm⁻¹ cm² mol⁻¹).

^cCalculated values are given in parenthesis.

Table 2

SPECTRAL DATA OF SCHIFF BASE AND THEIR COMPLEXES.

S.No.	Compounds	IR absorption bands (cm ⁻¹)					UV-Vis nm
		v(C=N)	v(N-H)	v(C=S)	v(C-Cl)	v(N-N)	
2a.	H ₂ cbsme	1593	2912	1284	752	1041	251, 300
3a.	[Cu(2cbsme)Cl ₂]	1601	---	---	750	1031	251, 364, 370
3b.	[Cu(2cbsme) ₂]	1599	---	---	756	1030	429, 605
3c.	[Mn(2cbsme) ₂]	1601			755	1032	252, 310, 398
3d.	[Zn(2cbsme) ₂]	1605			755	1034	262, 342, 412

The ¹H NMR spectra of the Schiff bases in DMSO-d₆ does not show any signal at 4.0 ppm due to the -S-H proton, indicating that in DMSO, it remains in their thione form. Thiosemicarbazones, which are closely related

to H₂cbsme, have been found to coordinate to metal ions in both the protonated thione form⁸ and the deprotonated thiolate form⁹. There are examples of metal complexes in which both the protonated thione and the deprotonated thiolate

forms of a thiosemicarbazone ligand are present in the same complex¹⁰.

However Schiff bases derived from S-alkyl esters of dithiocarbazic acid invariably deprotonate while coordinating with metal ions yielding complexes containing only the thiolate form of the ligand. So far, there has not been a single example of a metal-dithiocarbazate complex in which a thione tautomer has been found to be coordinated to a metal ion.

The IR bands of Schiff base and its complexes are summarized in Table 2. A comparison of the IR spectrum of the ligand with those of its complexes shows that the broad and weak band at 2912cm⁻¹ attributable to $\nu(\text{N-H})$, is not present in the spectra of the complexes indicating that the ligand is coordinated in its deprotonated form. In the past, evidence of coordination of thiosemicarbazone and dithiocarbazate ligands to metal ions via the azomethine nitrogen atom was based on shifting of the azomethine C=N band of the free ligand from lower to higher wave numbers in the spectra of metal complexes¹¹. However, shifting of this band to both higher¹² and lower¹³ wave numbers have been reported. Since the $\nu(\text{C=N})$ band is expected to couple with other bands, the shifting of this band will be dependent on how much it is in combination with other bands. In the IR spectra of the present complexes, the $\nu(\text{C=N})$ band is not shifted but the $\nu(\text{N-N})$ band of the free ligand shifts considerably to lower wave numbers supporting coordination via the azomethine nitrogen atom¹⁴.

The sharp $\nu(\text{C=S})$ bands at 1284 cm⁻¹ for ligands were also not observed in the metal complexes, thus supporting the suggestion of coordination through the thione sulphur and from the IR studies a band $\nu(\text{C-Cl})$ at 752 cm⁻¹ due to chloride group remains unchanged in all the complexes, suggesting non participation of chloride group in coordination with central metal ion.

Electronic spectral data are given in Table 2. The Schiff base spectral data exhibit a band in the 300 nm range, due to the $\pi-\pi$ transition within the azomethine group, affected by the intramolecular charge transfer within the ligand molecule. The electronic spectra of the Schiff base complexes under investigation do not resemble the free Schiff base, which is the supporting evidences for complex formation.

The electronic spectrum of the Mn(II) complex exhibited absorption band at 398 nm which are assigned to ${}^4\text{T}_{1g} \leftarrow {}^6\text{A}_{1g}$ transition, a square planar geometry has been suggested¹⁵⁻¹⁷.

The Cu(II) complex displays two bands at 429, 605 nm attributed to the ${}^2\text{B}_{1g} \rightarrow {}^2\text{A}_{1g}$, and ${}^2\text{B}_{1g} \rightarrow {}^2\text{E}_{1g}$ transitions (d-d), suggesting square planner geometry .

From the forgoing observations, the suggested chemical structures for the prepared Schiff base complexes under investigation are as follows:

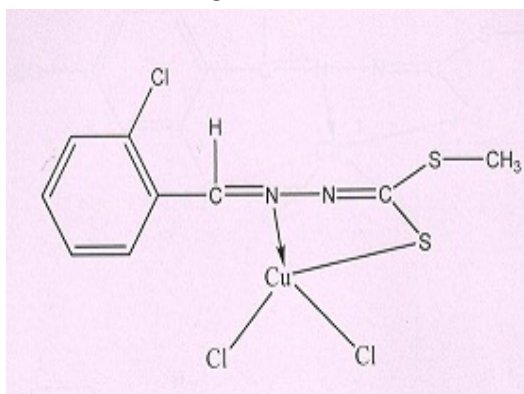
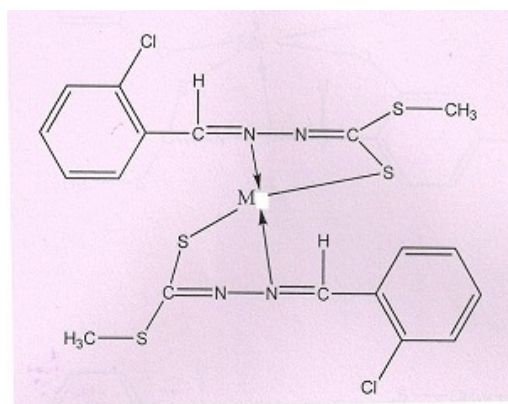


Fig 2. Proposed structure of the monochelated complexes,



M= Cu(II), Mn(II) and Zn(II)

Fig.3. Proposed structure of the bischelated complex.

Anti-microbial activity

The anti-bacterial activities were tested by disc diffusion method at 30µg/ml concentration and Ampicillin and tetracycline was used as a reference compound. *E. coli*, *S. aureus*, *pseudomonas* species and *S. albus* used as the bacterial test organisms. All the new complexes were also screened for anti-fungal activity against *Aspergillus niger*, *alternaria alternata* and *Candida* species at concentration of 50µg/ml using subroad and dextrose agar media, Amphotericin B disc were used as the standard drugs. 3b have shown moderate activity against bacteria and also shown significant activity against *Aspergillus niger* and *Candida* species. Compound 3c exhibit very little activity against these organisms.

References

1. A. Monaci, and F. Trali, *J. Chem. Soc. Dalton Trans.*, 499 (1980).
2. M.A. Ali, and S.E. Livingstone, *Coord. Chem. Rev.*, 13, 101 (1974).
3. M.R Maurya, S.S. Khurana, A Azam, W Zhang and D. Rehder, *Eur. J. Inorg. Chem.*, 1966 (2003).
4. A. Saxena, J. k. Koacher, and J.P.J Tandon, *Antibact. Antifung. Agents*, 9, 435 (1981).
5. S. Kirschner, Y.K. Wei, D. Trancis, J.G. Bergman, *J. Med. Chem.*, 9,369 (1966).
6. M. Das, S.E. Livingstone, *Inorg. Chem. Acta.*, 15, 5 (1976).
7. Rehder, J. Costa Pessoa, C.F.G.C. Geraldés, M.M.C.A. Castro, T. Kabanos, T. Kiss, B. Meier, G. Micera, L. Petterson, M. Rangel, A. Salifoglou, I. Turel, and D. Wang, *J. Biol. Inorg. Chem.*, 7, 384 (2002).
8. R. Gronbeak-Hazell, *Acta Chem. Scand.*, 26, 1653 (1992).
9. L. Carvalca, M. Nardelli, G. Fava, *Acta Crystallog.*, 15, 1139, (1962).
- 10.(a), M.D. Timken, S.R. Wilson, D. Hendrickson, *Inorg. Chem.*, 24, 3450 (1985).
(b). P. Souza, A.I. Matesanz, V. Fernandez, *J. Chem. Soc. Dalton Trans.*, 3011 (1996).
11. M. Mohan, P. Sharma, *Inorg. Chim. Acta.*, 106, 197 (1985).
12. (a) D.X. West, A.K. El-Sawaf, G.A. Bain, *Trans. Metal Chem.*, 23 (1998).
(b) A. Monaci, F. Trali, *J. Chem. Soc. Dalton Trans.*, 417 (1977).
13. (a) M.A. Ali, D.J. Phillips, S.E. Livingstone, *Inorg. Chim. Acta.*, 5, 493 (1971).
(b) M.A. Ali, D.J. Phillips, S.E. Livingstone, *Inorg. Chim. Acta.*, 5, 119 (1971).
14. R. Ugo. *J. Organomet. Chem.*, 9, 395 (1967).
15. H.B. Gray and C.J. Ballhausen, *J. Am. Chem. Soc.*, 85, 260 (1963).
16. M.A. Ali, M. Uddin, M. nazim Uddin, D.A Chowdhary, M.T.H. Tarafder, *Indian J. Chemistry*, 25A, 238-242, (1986)
17. M.A.Ali, M.H. Mirza, R.J. Butcher, *Polyhedron*, 20 (2001).

ASSOCIATION RULE MINING: A DATA PROFILING AND PROSPECTIVE APPROACH

Hemant Kumar Soni¹, Sanjiv Sharma², Pankaj K. Mishra³

¹Asst. Prof., Dept. of Computer Science, ASET, Amity University, Gwalior (M.P)

²Asst. Prof., Dept. of Computer Science, MITS, Gwalior (M.P)

³Asst. Prof., Dept. of Applied Science, ASET, Amity University, Gwalior (M.P)

Email:soni_hemant@rediffmail.com¹

Abstract

The Main objective of data mining is to find out the new, unknown and unpredictable information from huge database, which is useful and helps in decision making. There are number of techniques used in data mining to identify frequent pattern and mining rules includes clusters analysis, anomaly detection, association rule mining etc. In this paper we discuss the main concepts of association rule mining, their stages and industries demands of data mining. The pitfalls in the existing techniques of association rule mining and future direction is also present.

Keywords: Association Rule Mining, Frequent Pattern, Apriori, FP-Tree, Incremental data mining, support, confidence.

Introduction

Data Mining is the iterative and interactive process of discovering valid, novel, useful, and understandable and hidden patterns. Data Mining is used in extracting valuable information in large volumes of data using exploration and analysis. With an enormous amount of data stored in databases and data warehouses requires powerful tools for analysis and discovery of frequent patterns and association rules. In data mining, Association Rule Mining (ARM) is one of the important areas of research, and requires more attention to explore rigorously because it is a prominent part of Knowledge Discovery in Databases (KDD).

Application area of data mining is very vast, such as Remote Sensing, Geographical Information System, Cartography, environmental assessment & planning a name of few.

Association Rule Mining

Recently, researchers are applying the association rules to a wide variety of application domains such as Relational Databases, Data

Warehouses, Transactional Databases, and Advanced Database Systems like Object-Relational, Spatial and Temporal, Time-Series, Multimedia, Text, Heterogeneous, Legacy, Distributed, and web data [1].

Since data generated day by day activities, the volume of data is increasing dramatically. Massive amount of data is available in the data warehouses. Therefore, mining association rules helps in many business decision making processes. Some examples are cross-marketing, Basket data analysis and promotion assortment etc. In the area of association rules mining, a lot of studies have been done. The association rules mining first introduced in [2] [3] [4].

For a given transaction database T , An association rule is an implication of the form $X \Rightarrow Y$, where $X \subset I$, $Y \subset I$, and $X \cap Y = \Phi$, i.e. X and Y are two non-empty and non-intersecting itemsets. The rule $X \Rightarrow Y$ holds in the transaction set D with confidence c if $c\%$ of transactions in T that contain X also contain Y .

A transaction T is said to support an item i_k , if i_k is present in T . T is said to support a subset of

items $X \subseteq I$, if T support each item i_k in X . An itemset $X \subseteq I$ have a support s in D . It is denoted by $s(X)$. If $s\%$ of transactions in D support X . There is a user-defined minimum support threshold, which is a fraction, i.e., a number in $[0, 1]$.

$$\text{Support}(X \Rightarrow Y) = \frac{\text{Support}(X \cup Y)}{|D|} \quad \text{----- (1)}$$

The confidence of rule $X \Rightarrow Y$ is the fraction of transactions in D containing X that also contain Y . It indicates the strength of rule.

$$(X \Rightarrow Y) = \frac{\text{Support}(X \cup Y)}{\text{Support}(X)} \quad \text{----- (2)}$$

Stages in Association Rule Mining

In [3], the problem of discovering association rules is decomposed into two stages: Discovering all frequent patterns represented by large itemsets in the database, and generating the association rules from those frequent itemsets. The second sub problem is a straightforward problem, and can be managed in polynomial time. On the other hand, the first task is difficult especially for large databases. The Apriori [3] is the first efficient algorithm for solving the association rule mining, and many of the forthcoming algorithms are based on this algorithm.

Confidence denotes the strength of implication and support indicates the frequencies of the occurring patterns in the rule. It is often desirable to pay attention to only that rule which may have reasonably large support. Such rules with high confidence and strong support are referred to as strong rules [2] [5]. The prime objective of mining association rules is to discover strong association rules in large databases.

Applications of Data Mining

As data mining matures, new and increasingly innovative applications for it emerge. Although a wide variety of data mining scenarios can be described. Applications of data mining are divided as follows:

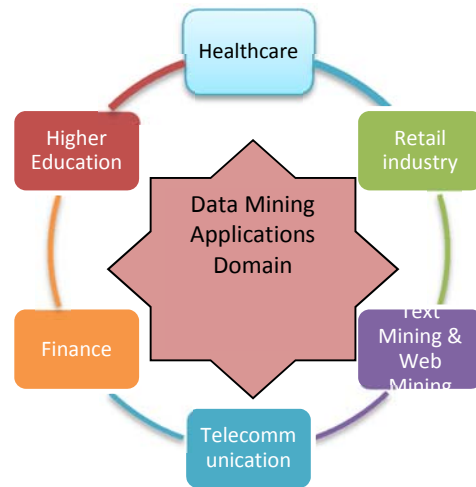


Figure 1 Data Mining Applications Domain 1.5 Industries demand of Data Mining

Data mining attract all kind of companies to provide valuable information that helps them to stay in the competition. It also help them in effective and efficient decision making and in future planning. Data mining is popular and successful in many areas in which data base marketing and credit card fraud detection is most popular. For example, the following areas of database marketing, in which data mining play an important role [6].

- a. **In Response Modeling** : Based on previous history and other data like demographic, geographic and life style data, data mining predicts which prospects are likely to buy.
- b. **In Cross Selling** : Based on the purchase pattern and frequently purchased items data mining helps in increases sales providing effective services to the existing customers.
- c. **In Customer retention**: Based on the customer buying habits and purchase patterns and analyzing the competitor’s policies, data mining helps in making strategies for customer retention.
- d. **In segmentation and profiling** : through classification and clustering, data mining helps in segmentation and profiling customers.

With the use of data base and information technology, data mining is valuable and useful in any industry or business sector. Some of the applications are given below [7] [8]:

- **Fraud detection**: Data mining helps in identifying fraudulent transactions.

- **Loan approval:** data mining techniques helps in establishing credit worthiness of a customer requesting a loan.
- **Investment analysis:** Based on the historical database, data mining predicting a portfolio's return on investment.
- **Portfolio trading:** Data mining support in trading a portfolio of financial instruments by maximizing returns and minimizing risks.
- **Marketing and sales data analysis:** Data Mining help in identifying potential customers; establishing the effectiveness of a sale campaign.
- **Manufacturing process analysis:** In manufacturing, data mining helps in identifying the causes of manufacturing problems.
- **Scientific data analysis:** large scientific data can also analyze with the help of data mining techniques.

Incremental Data Mining

Transaction database will increase in volume with the time. Since the database updated and increases, association rule mined from old database requires to be reevaluated. Database updation will change the support and confidence value, hence old association rule may turn out to be invalid and some new association rule may be relevant [9] [10]. Batch mining concept used by Apriori and FP-Tree mining Algorithm. Conservative batch mining algorithm like Apriori and FP-Tree algorithm resolves the incremental mining problem by re- processing of the entire new database, when new transactions are inserted.

Conclusion

Most of the researchers have considered association rule mining problems as single objective problem and validated on static database but it is a multi-objective problem because it uses measures like support count, comprehensibility and interestingness for mining the strong association rule [11] [12] [13] [14]. Since the database is being updated periodically due to daily business requirement. Incremental mining deals with generating association rules from updated database.

Most of the existing algorithms for incremental mining rescan the entire database again. Cost of scanning large database is high. The association rules generated on static database are not

meaningful, effective and not appropriate for making business strategies and decisions. Hence, it requires to devise a new and efficient algorithms for incremental mining without rescanning of database. Therefore, there is a need to shift the paradigm form single objective to multi-objective association rule mining and also requires consideration of incremental data.

Data mining is a new and significant area of research, and soft computing tools itself are extremely appropriate to solve the problems. Soft computing characteristics include high robustness, parallel processing, self organizing adaptive, high degree of fault tolerance distributed storage etc are much suitable for data mining applications. It also obtain a greater attention in Artificial Neural Networks, which offer qualitative methods for business and economic systems.

Reference

1. Luo, D., Cao, L., Luo, C., Zhang, C., and Wang, W. "Towards business interestingness in actionable knowledge discovery", IOS Press, Vol. 177, pp 101-111, 2008.
2. R. Agrawal ,T. Imielinski and A. Swami, "Mining Association Rules between sets of Items in large Databases". In Proc. 1993 ACM-SIGMOD, Int. Conf. Management of Data (SIGMOD'93), pp 207-216 Washington ,DC, May 1993
3. R. Agarwal and R. Srikant, "Fast Algorithm for Mining Association Rules". In Proc. 1994, Int. conf. Very Large Data Bases (VLD'94), pp 487-499, Santiago, Chile, Sept'94.
4. M. Houtsma and A. Swami. "Set-Oriented Mining of Association Rules". Research Report RJ 9567, IBM Almaden Research Centre ,San Jose ,California, Oct.'93.
5. Piatetsky – Shapire (Editor),"Knowledge Discovery in Databases" ,AAAI/MIT Press ,1991
6. Chengqi Zhang Shichao Zhang, "Association Rule Mining - Models and Algorithms", Springer , 2002
7. U. M. Fayyad and E. Simoudis, "Data mining and knowledge discovery". In: *Proceedings of 1st International Conf. Prac. App. KDD& Data Mining*, pp 3-16, 1997.
8. G. Piatetsky - Shapiro and C. Matheus," Knowledge discovery workbench for exploring business databases". *International Journal of Intelligent Systems*, 7, pp 675-686, 1992.

9. W. Cheung and O. R. Zaiane. "Incremental Mining of Frequent Patterns without Candidate Generation or Support Constraint". Proceedings of the 7th International Database Engineering and Application Symposium, pp 111- 116, July 2003
10. B.Xu ,T.Yi, F Wu and Z Chen. "An incremental updating algorithm for mining association rules", Journal of electronics, pp 403-407,2002.
11. P. Wakabi-Waiswa and V. Baryamureeba, "Mining High Quality Association Rules using Genetic Algorithms", In *Proceedings of the twenty second Midwest Artificial Intelligence and Cognitive Science Conference*, pp. 73-78, 2009.
12. M. Anandhavalli and S. Kumar Sudhanshu, A. Kumar and M.K. Ghose, "Optimized Association Rule Mining Using Genetic Algorithm", *Advances in Information Mining*, vol. 1, issue 2, pp. 01-04, 2009.
13. Ghosh S., Biswas S., Sarkar Dand Sarkar P.P., "Mining Frequent Itemsets Using Genetic Algorithm", *International Journal of Artificial Intelligence & Applications*, Vol. 1, No. 4, pp. 133-143, 2010
14. W. Soto and A. Olaya-Benavides, "A Genetic Algorithm for Discovery of Association Rules." In *Computer Science Society (SCCC)*, pp. 289-293, 2011.

BENEFITS OF SOFTWARE REUSE

T.Rajani Devi¹, B.Rama²

¹PG Scholar, Department of Computer Science, Kakatiya University

²Prof., Department of Computer Science, Kakatiya University

Email: Rajanireddy28@gmail.com¹, rama.abbidi@gmail.com²

Abstract

Software reuse has become much more interesting in software community due to its potential benefits, Economic benefits, and time saving also for improving the productivity and quality of software projects. Software reuse refers to a situation in which some software is used in more than one project. Here “Software” is defined loosely as items that are considered part of an organization’s standard. Thus “software” could refer either to source code or to other products such as requirements, designs, test plans, test suites, or documentation.

Keywords: artifacts, repositories, software reuse, systematic reuse.

I. INTRODUCTION

Simply “software reuse” refers to a situation in which some software is used in more than one project. Simply software reuse can be defined as the process of creating software systems from existing software assets rather than building them from scratch. Software assets, or components, include all software products, from requirements and proposals, to specifications and designs, to user manuals and test suites. In general anything that is produced from a software development effort can potentially be reused. Software reuse has several different meanings in the software engineering community. Different individuals have viewpoints that depend upon their responsibilities.

Software reuse is the process of implementing or updating software systems using existing software assets.

The systematic reuse of these components as building blocks to create new system

Simply software reuse can be defined as the process of creating software systems from existing software assets rather than building them from scratch. Software assets, or components, include all software products, from requirements and proposals, to specifications

and designs, to user manuals and test suites. In general anything that is produced from a software development effort can potentially be reused.

Act: Reuse of previously built software artifact/asset to fulfill need in new development task or sub-task

Field: Study of methodologies, practices, processes, techniques, languages, frameworks, CASE tools that foster and facilitate reuse

Motivation: Avoiding wasting time and money redoing same task over and over. Quality standard of previously completed task carries over to new occurrences of same need



4 pillars of agile software reuse

II. WHAT TO REUSE?

A. A software asset:

Any artifact resulting from one stage in a development task. Any mapping from the artifact produced by one development stage to the artifact produced by the next

Assets can be at any level of abstraction and software process stage:

- a) *Domain/business analysis/model.*
- b) *Application requirements.*
- c) *Application architectures and generic architecture patterns.*
- d) *Application design/model and generic design patterns*
- e) *Source code.*
- f) *Libraries, modules, packages, Classes, templates, idioms, Objects, functions, subroutines, data.*
- g) *Executable code: executable components, bytecode, binary code.*
- h) *Documentation and meta-data.*
- i) *Test suites and test generators.*
- j) *Any information, formalism or tool used during development can also be subject to reuse.*
- k) *Languages, CASE tools, IDE, processes.*

III. TYPES OF SOFTWARE REUSE

A. Horizontal Reuse

Horizontal reuse refers to software components used across a wide variety of applications. In terms of code assets, this includes the typically envisioned library of components, such as a linked list class, string manipulation routines, or graphical user interface functions. Horizontal reuse can also refer to the use of a commercial off-the-shelf (COTS) or third-party application within a larger system, such as an e-mail package or a word processing program.

B. Vertical Reuse

Vertical reuse the reuse of system functional areas, or domains that can be used by a family of systems with similar functionality. Vertical reuse, significantly untapped by the software community at large, but potentially very useful, has far reaching implications for current and future software development efforts. The basic idea is the reuse of system functional areas, or domains that can be used by a family of systems with similar functionality. The study and application of this idea has spawned another engineering discipline, called domain engineering. Domain engineering is "a comprehensive, iterative, life-cycle process that an organization uses to pursue strategic business objectives. It increases the productivity of

application engineering projects through the standardization of a product family and an associated production process." This gets us to application engineering, the domain engineering counterpart: "Application engineering is the means by which a project creates a product to meet a customer's requirements. The form and structure of the application engineering activity are crafted by domain engineering so that each project working in a business area can leverage common knowledge and assets to deliver a high-quality product, tailored to the needs of its customer, with reduced cost and risk." Domain engineering focuses on the creation and maintenance of reuse repositories of functional areas, while application engineering makes use of those repositories to implement new products. Domain engineering is the key concept and focus of current reuse efforts. The prospect of being able to reuse entire tested subsystems without change is a win-win situation for both customers and software organizations.

IV. CHARACTERISTICS OF VERTICAL AND HORIZONTAL REUSE

A. Characteristics of vertical reuse:

1. Applicability: Only for applications within a specific domain or closely related domains. This is the primary focus when building product lines.

2. Domain relevance: High

3. Availability outside the firm (i.e. commercial and/or open-source solutions): Low. Domain specific assets tend to be unique and create value by differentiating your firm from its competition. Hence, availability outside the firm tends to be low.

4. Potential to create competitive advantage: High.

5. Asset Variability: Varies from well-defined to open-ended depending on the complexity in the domain. Variations typically aren't well understood and even if they are, they may not be accurately. Captured in reusable assets.

6. Key stakeholders: Has to be a combination of business stakeholders and technology. Business knowledge is fundamental to capturing domain variations and relationships and technical expertise is necessary to produce executable software.

7. Relationship with SOA & BPM: These assets are typically business services, data services, business rules, etc.

B. Characteristics of Horizontal reuse:

1. Applicability: Applicable across the board for applications regardless of domain. These assets typically tend to be utilities that are generic to multiple applications.
2. Domain relevance: Low and can be non-existent.
3. Availability outside the firm (i.e. commercial and/or open-source solutions): High. Domain agnostic assets don't tend to be unique to a particular organization. E.g. logging or simple data transformations etc.
4. Potential to create competitive advantage: Low
5. Asset Variability: Tend to be more well-defined than open-ended. Reason? Variations are well known, tend to change less over time, and have been analyzed several times.
6. Key stakeholders: Tend to be primarily technology. Some assets may require operations or production support teams to provide input as well. E.g. your firm may have a logging or error handling standard that the reusable asset needs to adhere to.
7. Relationship with SOA & BPM: These assets are typically utility services. Only for applications within a specific domain or closely related domains. This is the primary focus when building product lines.

V. ADVANTAGE OF SOFTWARE REUSE

The systematic development of reusable components. The systematic reuse of these components as building blocks to create new systems. A reusable component may be code, but the bigger benefits of reuse come from a broader and higher-level view of what can be reused. Software specifications, designs, tests cases, data, prototypes, plans, documentation, frameworks, and templates are all candidates for reuse. Reuse can cut software development time and costs. The major advantages for software reuse are to:

- a) *Increase software productivity.*
- b) *Shorten software development time.*
- c) *Improve software system interoperability.*

- d) *Develop software with fewer people.*
- e) *Move personnel more easily from project to project.*
- f) *Reduce software development and maintenance costs.*
- g) *Produce more standardized software.*
- h) *Produce better quality software and provide a powerful competitive advantage.*

A. Reuse benefits and problems

Benefits:

1. *Increased dependability*
2. *Reduced process risk*
3. *Effective use of specialists*
4. *Standards compliance*
5. *Accelerated development adapting*

Problems:

1. *Increased maintenance costs*
2. *Lack of tool support*
3. *Not-invented-here syndrome*
4. *Creating and maintaining Component library*
5. *Finding, understanding reusable components*

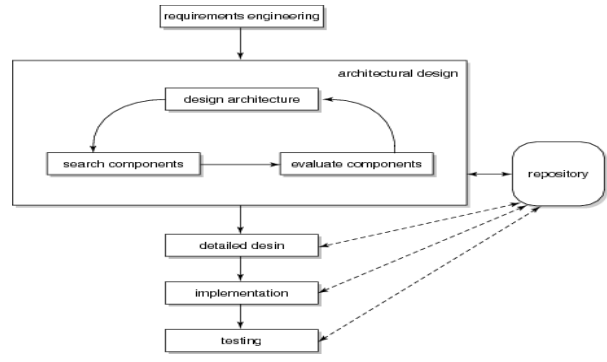
VI. WHERE TO START SOFTWARE DEVELOPMENT WITH REUSE?

The traditional software development process does not take into account reuse. Typically software projects are built as a onetime only entity with no support for reuse. They offer no flexibility for future reuse. Here the problem lies with the software development process. Thus there is a need for a new approach to software development with software reuse in mind. This can be achieved in one way by having a product line approach. A product line can be defined as a group of similar products usually catering a specific market segment. This gives a great opportunity for reuse. Thus generalization is the key to successful software reuse. It enables one to create a new product from existing components or products.

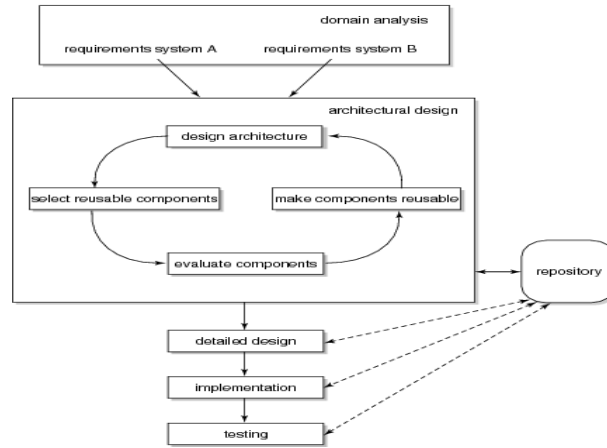
Managed reuse, in which reuse is built into the software development and maintenance processes, is the key to getting reuse to have an impact on the bottom line. Reuse management is much more important for this than is reuse technology. The technology, such as repositories, catalogs, or sophisticated browsers,

will be much more beneficial if the management infrastructure and planning for reuse are sound. [1] There is a need for strong commitment towards the goal of reuse. The goals of reuse, as defined in the Software Reuse Key Process Area of the Software Engineering Institute's (SEI) Capability Maturity Model, are to (1) Incorporate reusable software assets into new or existing applications and (2) Collect, evaluate, and make available to software projects reusable software assets. SEI claims that two important commitments must be made by an organization as well: (1) to follow a written policy which outlines the software reuse tasks in the software process and the methods and tools to identify, build, acquire, and reuse assets, and (2) to maintain the reusable assets by storing and providing an identification mechanism.

Incorporation of reuse in the software development process is not a straight forward task. Even companies those are willing to make long-term investments need a solid strategy to ensure that those investments will pay off. There are many potential obstacles that could be avoided with the right planning and infrastructure. On the other hand, investing in misdirected discipline, architecture, planning and infrastructure will not help you achieve reuse. If you make investments in the name of reuse but don't deliver, even after the expected learning curve, you could ruin the prospects for reintroducing reuse at a later date. In other words, although you are well poised to take advantage of managed software reuse, it is critical to learn everything you can about growing a reuse program the right way. Sufficient resources and funding must be provided for incorporating software reuse, including technical skills (domain analysis, development of reusable assets, asset storage and identification), tools, and incentive to build reusable assets as well as use them



Software development for reuse



VII. TOOLS USED IN REUSE

Component management tools, such as repositories, for architectures, designs, documentation, and code must be developed and maintained. Domain analysis tools and procedures for the development and maintenance of a domain architecture.

VIII. CONCLUSION

Software reuse is proved to be an efficient way to help improving software development quality, productivity during all these years' practices. Although it is not perfect, but is still worthy more research effort. We can reuse different things code, design.

Reuse can be *systematic* (software development *for* reuse), or *opportunistic* (software development *with* reuse) software reuse will not achieve its expected benefits unless reuse is systematized. The product line approach to software reuse requires substantial upfront investment with substantial, but not immediate, benefits. Much commitment, planning, and effort are required to begin a reuse program. Reuse processes and procedures must

be incorporated into the existing software development process. Components should be built specifically for reuse. Domain Engineering takes advantage of the similarities inherent in systems within one domain and builds a domain model that defines the basic structure for existing and future requirements. With appropriate software reuse process in place substantial benefits can be achieved in almost all facets of software development. Reuse does not just happen; it needs to be planned.

REFERENCES

- [1] W. B. Frakes and K. Kang, "Software reuse research: Status and future," *IEEE transactions on Software Engineering*, vol. 31, no. 7, pp. 529–536, 2005.
- [2] M. Morisio, M. Ezran, and C. Tully, "Success and failure factors in software reuse," *Software Engineering, IEEE Transactions on*, vol. 28, No. 4, pp. 340–357, 2002.
- [3] Frakes, WB. I soda, s.: success factors of systematic software reuse .IEEE Software11(01) (1994) 14-19.
- [4] Will T, "Software reuse myths revisited", Loral federal Systems Company.
- [5] Wegner, P. (1989). Capital-intensive software technology. *Software Reusability: Concepts and Models*. J. B. Ted and J. P. Alan. New York, New York, ACM Addison Wesley Publishing Company. 1: 43-97.
- [6] [S Reusability] R. Prieto-Diaz. *Status Report: Software Reusability*. IEEE Software. 10(3): 61-66, 1993.

VIBRATION ANALYSIS OF FUNCTIONALLY GRADED PLATES WITH MULTIPLE CIRCULAR CUTOUTS

Avadesh K Sharma¹, Premanand S. Chauhan², Manoj Narwaria³, Rajkumar Pankaj⁴

¹Asst. Prof., Department of Mechanical Engineering., MITS, Gwalior (M.P)

²Prof., Department of Mechanical Engineering, IPS-CTM, Gwalior (M.P)

³Associate Prof., Department of Mechanical Engineering, IPS-CTM, Gwalior (M.P)

⁴Research Scholar, Department of Mechanical Engineering, MGCGV, Chitrakoot, Satna (M.P)

Email: sharma.avadesh@gmail.com¹, prempunit@gmail.com²,
manoj.narwariya@gmail.com³, raj_mits2003@yahoo.co.in⁴

Abstract

This paper presents free vibration analysis of functionally graded plates with multiple circular cutouts. Finite element method is used to investigate the free vibration of functionally graded plates. The material properties of the plates are assumed to vary according to a power law distribution in terms of the volume fraction of the constituents. In this paper, the effects of volume fraction index, thickness ratio and different boundary conditions on the natural frequencies of plates is studied.

1. Introduction

In functionally graded materials, the volume fraction of two or more constitute materials are varied continuously as a function of position along certain dimension of the structure. The continuous change in the microstructure of the functionally graded materials advances them from the composite materials. The FGM is used in casing of sensors of the space shuttle so that it can carry thermal as well as mechanical load. In FGM's these problems are avoided or gradually reduced by varying the volume fraction of constituents of FGM. The concept of FGM was first considered in Japan in 1984 during a space plane project, where a combination of materials used would serve the purpose of a thermal barrier capable of withstanding a surface temperature of 2000 K and a temperature gradient of 1000 K across a 10 mm section [1]. Since the concept of FGM was first proposed, FGM's are extensively studied by researchers, who have mainly focused on their static, dynamic and thermal behavior. The problems of free vibrations, wave propagation and static deformations in FGM beams were solved using an especially developed finite element method accounting for power law and other alternative

variations of elastic and thermal properties in the thickness direction [2-3]. The modal employed a first order shear deformation theory of beam. Three methods were used for the static and dynamic analyses of square thick FGM plates with simply supported edges [4]. The methods employed in the paper included a higher order shear deformation theory and two novel solutions for FGM structures. According to this paper, the application of the normal deformation theory may be justified if the in-plane size to thickness is equal to or smaller than 5.

Researchers have also turned their attention to the vibration and dynamic response of FGM's structures [5-7]. Chen et al [8] presented exact solutions for free vibration analysis of rectangular plates using Bessel functions with three edges conditions. Liew et al [9] studied the free vibration analysis of functionally graded plates using the element-free Kp-Ritz method. They studied the free vibration analysis of four types of functionally graded rectangular and skew plates. Hiroyuki Matsunaga [10] presented in his paper, the analysis of natural frequencies and buckling of FGM's plates by taking into account the effects of transverse shear and normal deformations and

rotary inertia. Atashipour et al [11] presented a new exact closed- form procedure to solve free vibration analysis of FGM's rectangular thick plates based on the Reddy's third-order shear deformation plate theory.

For plates with cutouts, Chai [12] presented finite element and some experimental results on the free vibration of symmetric composite plates with central hole. Sakiyama and Huang [13] proposed an approximate method for analyzing the free vibration of square plate with different cutouts. Liu, et al [14] studied static and free vibration analyses of composite plates with different cutouts via a linearly conforming radial point interpolation method. Maziar and Iman [15] studied the effect of relative distance of cutouts and size of cutouts on natural frequencies of FG plates with cutouts. Sharma and Mittal [16-19] studied the free vibration analysis of laminated composite plates using finite element method.

From the review of the above literature it is observed that very little research and analysis work has been done yet on the natural frequencies of the FG plates with cutouts. The study presents here, the effect of volume fraction

index, thickness ratio and different external boundary conditions on the natural frequencies of FG (Al/Al₂O₃) plates i.e. rectangular, trapezoidal and circular plates with circular cutouts.

2. Functionally Graded Material Properties

A functionally graded material plate as shown in Fig. 1 is considered to be a plate of uniform thickness that is made of ceramic and metal. The material property is to be graded through the thickness according to a Power-Law distribution that is

$$P(z) = P_m + (P_c - P_m)V_f, \quad (1a)$$

$$V_f = \left(\frac{z}{h}\right)^n \quad (n \geq 0), \quad (1b)$$

Where P represents the effective material property, P_c and P_m denotes the ceramic and metal properties respectively, V_f is the volume fraction of the ceramic, h is the thickness of the plate, $0 \leq z \leq h$ and n is the volume fraction index.

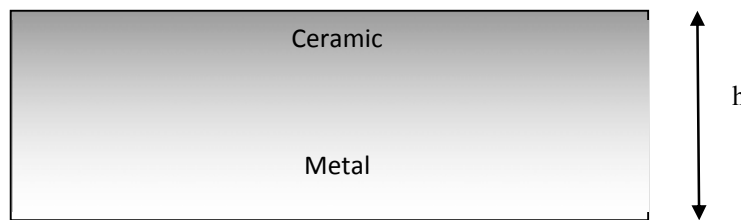


Fig. 1: Functionally Graded Plate

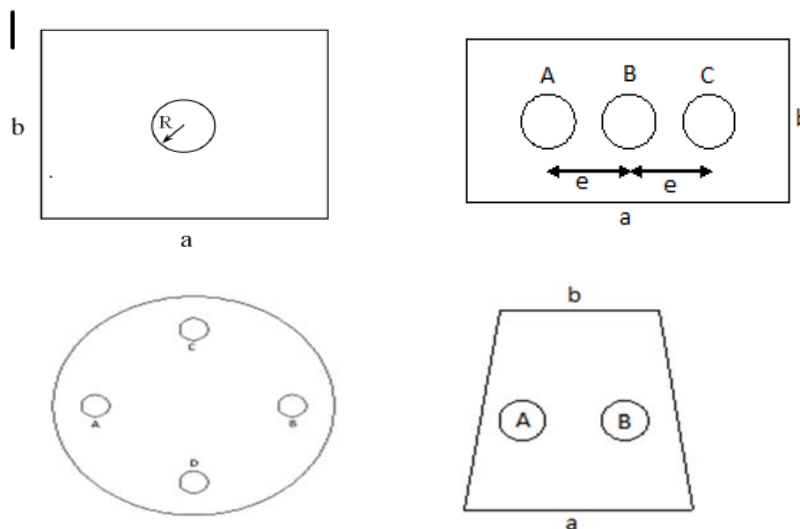


Fig. 2: Different Geometries of a functionally graded plates with circular cutouts

3. Functionally Graded Plate Elements

The finite element software (ANSYS) is used with the aim of analyzing. In addition SOLID 185 is used for modeling general 3-D solid structures. It allows for prism and tetrahedral

degenerations when used in irregular regions. The element is defined by eight nodes having three degree of freedom at each node. More than 2000 nodes might be used in calculation work

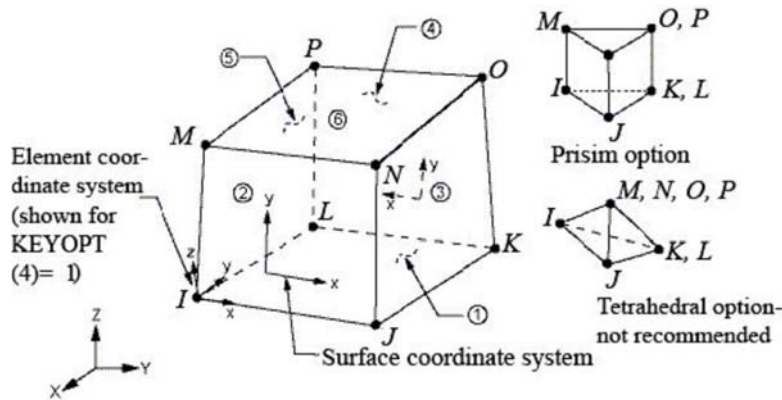


Fig. 3: SOLID 185

4. Numerical Results and Discussion

The material properties used in the convergence study are as follows:

$$E_t = 70 \text{ GPa}, \quad \nu_t = 0.3, \quad \rho_t = 3800 \text{ Kg/m}^3, \\ \alpha_t = 7.4 \times 10^{-6} / ^\circ\text{C}, \quad K_t = 65 \text{ W/mk} \\ E_b = 70 \text{ GPa}, \quad \nu_b = 0.3, \quad \rho_b = 2700 \text{ Kg/m}^3, \\ \alpha_b = 7.4 \times 10^{-6} / ^\circ\text{C}, \quad K_b = 65 \text{ W/mk}$$

In order to show the accuracy of methodology used for free vibration analysis of FG plates with cutouts, the fundamental natural frequencies of different plates (such as rectangular, trapezoidal and circular plates with circular cutouts) are

compared with the solutions presented by Maziar and Iman [15].

4.1 Isotropic plates

A square plate with a circular cutout at the center is shown in Fig. 2, the length of this plate is $a=10$, the ratio of the radius to length is $r/a = 0.1$ and the thickness ratio is $h/a = 0:01$. The material properties are the same as above. Table 1 provides a comparison between present results and solution given by Huang and Sakiyama [13] and Liu et al [14] for a simply supported plate.

Table 1: Nondimensional frequencies of isotropic square plate with square cutout at the center (simply support for external boundaries, $\varpi = [\rho h \omega^2 a^4 / (D(1 - \nu^2))]$, $h/a = 0.01$).

Mode	Present	Liu et al [14]	Huang et al [13]
1	4.540	6.149	6.240
2	7.223	8.577	8.457
3	7.231	8.634	8.462
4	9.124	10.42	10.23
5	10.23	11.41	11.72
6	10.56	11.84	12.30
7	11.79	12.83	13.04
8	11.80	12.84	13.04
9	13.54	-	-

10	13.56	-	-
----	-------	---	---

Table 2 shows the comparison of natural frequencies of FG rectangular plate of side ratio $a/b=2$ having three holes of radius ratio $r/b=0.15$ and centre to centre distance ratio $e/b=0.7$.

Table 2: Comparison of natural frequencies of FG rectangular plate with three circular cutouts (fully clamped for external boundaries)

e/b	Mode									
	1	2	3	4	5	6	7	8	9	10
0.7	496.99	607.47	931.21	1135.2	1221.3	1268.9	1436.0	1719.8	1727.1	1850.5
Iman[15]	500.45	614.97	931.33	1161.6	1249.9	1286.0	1458.8	1777.2	1800.5	2103.7

Table 3 shows the comparison of natural frequencies of FG circular plate of same radius and thickness with four holes of radius $r=0.1$ at location $A(x/R=-0.7, y/R=0)$, $B(x/R=0.7, y/R=0)$, $C(x/R=0, y/R=0.7)$ and $D(x/R=0, y/R=-0.7)$ respectively.

Table 3: Comparison of natural frequencies of FG circular disc with four circular cutouts (fully clamped for external boundaries)

e/b	Mode									
	1	2	3	4	5	6	7	8	9	10
0.7	209.46	435.34	437.12	699.64	718.95	847.69	1032.8	1038.8	1267.6	1278.5
[15]	201.00	418.02	418.72	671.82	688.25	780.02	987.20	988.24	1180.6	1184.8

Table 4 shows the variation of natural frequencies of Al/Al₂O₃ FG rectangular plates with two circular holes (clamped-simply supported for external boundaries) with different thickness ratio of the plate as $h/b=0.04, 0.06$ and 0.08 respectively. The results for first ten modes

are computed. For the FG plates with fully clamped external boundary condition, the frequencies in all ten modes decreases as the volume fraction index increases. This is expected, because a large volume fraction index means that a plate has a smaller ceramic component and thus its stiffness is reduced.

Table 4: Variation of natural frequencies with the volume fraction index n for Al/Al₂O₃ FG rectangular plates with two circular holes (clamped-simply supported for external boundaries)

h/b	n	Mode									
		1	2	3	4	5	6	7	8	9	10
0.04	0	947.24	1224.8	1626.3	2258.2	2268.8	2491.6	2904.2	3121.6	3471.2	3915.7
	0.5	820.68	1016.9	1351.7	1871.3	1908.9	2022.8	2459.4	2595.7	2935.5	3250.9
	1	656.15	838.38	1102.7	1529.6	1568.3	1693.9	2001.8	2126.1	2449.1	2676.4
	2	657.42	814.09	1065.0	1446.6	1544.4	1588.6	2025.9	2141.1	2375.7	2440.4
0.06	0	1323.4	1705.4	2227.5	3068.9	3099.0	3310.3	3935.5	4103.8	4223.3	4675.4
	0.5	1077.2	1348.3	1763.3	2423.2	2515.5	2643.2	3209.5	3332.1	3726.4	3774.7
	1	886.91	1082.2	1434.1	1970.5	2028.0	2155.2	2608.4	2737.3	3121.3	3379.1
	2	720.36	909.95	1191.0	1648.5	1671.2	1773.8	2135.5	2297.3	2560.3	2804.4
0.08	0	1675.1	2129.4	2790.8	3709.6	3848.1	4064.1	4124.2	4819.7	5168.5	5341.2
	0.5	1292.8	1620.9	2118.5	2910.1	2932.2	3129.5	3734.0	3776.9	4032.5	4493.6
	1	1005.4	1273.3	1682.3	2315.7	2331.2	2514.7	2971.7	3213.9	3403.9	3551.8

2	884.57	1094.8	1448.1	1978.4	1991.1	2133.8	2513.1	2773.8	2878.7	3008.4
---	--------	--------	--------	--------	--------	--------	--------	--------	--------	--------

Table 5 shows the variation of natural frequencies of Al/Al₂O₃ FG trapezoidal plates with two circular holes (clamped-simply supported for external boundaries) with different thickness ratio of the plate is h/b=0.04, 0.06 and 0.08 respectively. The results for first ten modes

are computed. For the FG plates with fully clamped external boundary condition, the frequencies in all ten modes decreases as the volume fraction index increases. This is expected, because a large volume fraction index means that a plate has a smaller ceramic component and thus its stiffness is reduced

Table 5: Variation of natural frequencies with the volume fraction index *n* for Al/Al₂O₃ FG trapezoidal plates with two circular holes (clamped-simply supported for external boundaries)

h/a	n	Mode									
		1	2	3	4	5	6	7	8	9	10
0.04	0	2137.5	3888.6	4489.3	5591.4	6346.1	6612.5	7048.6	7454.2	7561.0	8406.7
	0.5	1581.1	2956.3	3381.0	4249.1	4831.1	5756.8	5965.9	6365.0	6537.0	6779.1
	1	1213.9	2294.9	2616.8	3342.3	3835.7	4563.0	5144.5	5400.3	5480.4	5800.6
	2	1035.7	1931.1	2179.7	2813.5	3147.1	3764.5	4353.4	4401.8	4586.3	4891.1
0.06	0	2716.8	4861.4	5622.0	6709.5	6848.4	7130.4	7627.8	7726.7	8731.4	9117.9
	0.5	2097.2	3785.4	4427.5	5537.2	6036.1	6199.2	6421.1	6892.1	7346.8	7859.9
	1	1640.5	2987.4	3454.8	4348.0	4879.5	5459.9	5767.2	5839.2	6252.0	6643.5
	2	1350.7	2459.8	2799.9	3477.2	3941.7	4585.9	4691.1	4896.5	5249.9	5323.3
0.08	0	3241.9	5743.5	6625.7	6819.6	7190.7	7725.4	7955.9	8843.2	8933.1	9474.2
	0.5	2533.2	4452.6	5150.2	6080.4	6346.6	6457.9	6932.7	7141.5	7951.8	8373.3
	1	2070.4	3733.9	4240.1	5266.4	5510.2	5845.2	5972.7	6285.2	6982.7	7161.5
	2	1616.5	2898.5	3308.3	4034.6	4578.9	4606.5	4893.3	5265.2	5331.4	5943.9

The variation of first ten natural frequencies with the thickness ratio is depicted in Fig. 4.

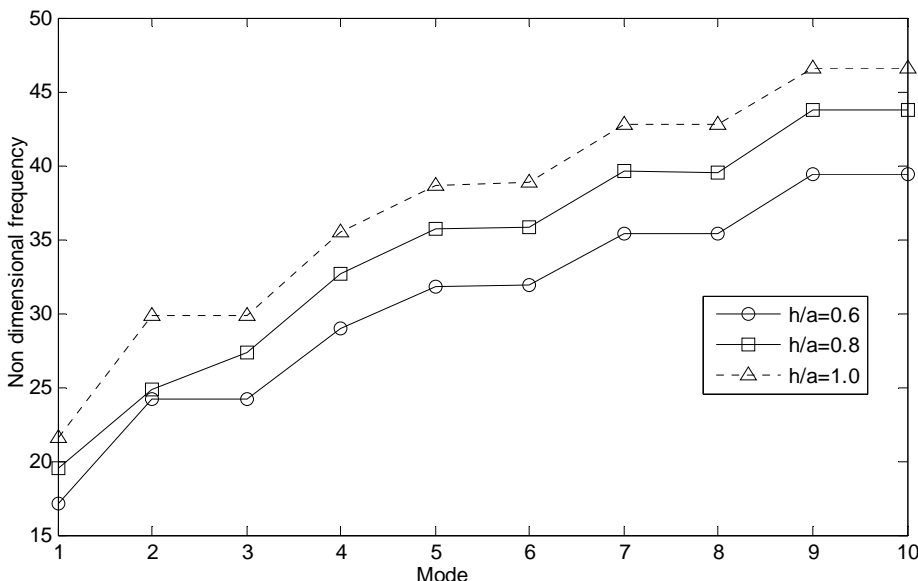


Fig.4: Effect of variation of thickness ratio on the first ten natural frequencies of square plate

5. Conclusions

In this paper, free vibration behavior of functionally graded plates with circular cutouts has been carried out using APDL code in

ANSYS and results are validated with the available published results. The elastic properties of FG plates are assumed to vary through the thickness according to a power law. It is found

that a volume fraction exponent that ranges between 0 and 1 has a significant influence on the natural frequency of FG plates with cutouts. For rectangular, trapezoidal and circular FG plates with circular cutouts, the natural frequency decreases as the volume fraction index increases.

References

- [1] Functionally Graded Materials (FGM) and Their Production Methods”, Azom.com.
- [2] A. Chakraborty, S. Gopalakrishnan and J.N. Reddy, “A New Beam Finite Element for the Analysis of Functionally Graded Materials”, *Int. J. of Mechanical Science* 45 (2003), pp. 519-539.
- [3] A. Chakraborty and S. Gopalakrishnan, “A Spectrally Formulated Finite Element for Wave Propagation Analysis in Functionally Graded Beam”, *Int. J. of Solids and Structures*, 40 (2003), pp. 2421-2448.
- [4] L. F. Qian, R.C. Batra and L. M. Chen, “Static and Dynamic Deformation of Thick Functionally Graded Elastic Plates by Using Higher Order Shear and Normal Deformable Plate Theory and Meshless Local Petrov-Galerkin Method”, *Composites, Part B* 35 (2005), pp. 685-697.
- [5] H.L. Dai, X. Wang, “Thermo-Electro-Elastic Transient Responses in Piezoelectric Hollow Structures”, *Int. J. of Solids and Structures* 42 (2005), pp. 1151-1171.
- [6] X. L. Huang, S. H. Shen, “Nonlinear Vibration and Dynamic Response of Functionally Graded Plates in Thermal Environments”, *Int. J. of Solids and Structures* 41 (2004), pp. 2403-2427.
- [7] J. Yang, S. H. Sheen, “Free Vibration and Parametric Response of Shear Deformable Functionally Graded Cylindrical Panels”, *Journal of Sound and Vibration* 261 (2003), pp. 871-893.
- [8] Jiu Hui Wu, A.Q. Liu and H. L. Chen, “Exact Solutions for Free Vibration Analysis of Rectangular Plate using Bessel Functions”, *Journal of Applied Mechanics* 74 (2007), pp. 1247-1251.
- [9] X. Zhao, Y. Y. Lee and K. M. Liew, “Free Vibration Analysis of Functionally Graded Plates using the Element-Free Kp-Ritz Method”, *Int. J. of Sound and Vibration* 319 (2009), pp. 918-939.
- [10] Hiroyuki Matsunaga, “Free Vibration and Stability of Functionally Graded Plates According to a 2-D Higher-Order Deformation Theory”, *Int. J. of Composite Structures* 82 (2008), pp. 499-512.
- [11] Ah. Hosseini- Hashemi, M. Fadaee and S. R. Atashipour, “Study on the Free Vibration of Thick Functionally Graded Rectangular Plates According to a New Exact Closed-Form Procedure”, *Int. J. of Composite Structures* 93 (2011), pp. 722-735.
- [12] B. G. Chai, “Free Vibration of Laminated Plates with a Central Circular Hole”, *Journal of Composite Structures* 35 (1996), pp. 357-368.
- [13] T. Sakiyama, M. Huang, “Free Vibration Analysis of Rectangular Plates with Variously Shape-Hole”, *Journal of Sound and Vibration* 226 (1996), pp. 769-786.
- [14] G. R. Liu, X. Zhao, K.Y. Dai, Z.H. Zhong, G. Y. Li and X. Han, “Static and Free Vibration Analysis of Laminated Composite Plates using the Conforming Radial Point Interpolation Method”, *Int. J. of Composites Science and Technology* 68 (2008), pp. 354-366.

- [15] J. Maziar and R. Iman, "Free Vibration Analysis of Functionally Graded Plates with Multiple Circular and Non-circular Cutouts", *Chinese Journal of Mechanical Engineering* 24 (2011).
- [16] Sharma A.K., Mittal N.D., Review on stress and vibration analysis of composite plates, *Journal of Applied Sciences*, 10(23), 2010, 3156-3166.
- [17] Sharma A.K., Mittal N.D., Free vibration analysis of laminated composite plates with elastically restrained edges using FEM, *Central European Journal of Engineering*, 3(2) (2013) 306-315.
- [18] Sharma, A.K. & Mittal, N.D., Sharma A., Free vibration analysis of moderately thick antisymmetric cross-ply laminated rectangular plates with elastic edge constraints. *International Journal of Mechanical Sciences*, 53, 2011, 688–695.
- [19] Sharma, A. K. & Mittal, N.D., Free vibration analysis of moderately thick Anti-symmetric angle ply laminated rectangular plates with elastic edge constraints. *Mechanics of Advanced Materials and Structures*, 21, 2014, 341–348
- [20] Rutishauser H., "Simultaneous Iteration Method for Symmetric Matrices", *Int. J. of Numerische Mathematik* 16(1970), pp. 205-223.
- [21] Rutishauser H., "Computational Aspects of F. L. Bauer's Simultaneous Iteration Method", *Int. J. of Numerische Mathematik* 13 (1969), pp. 4-13.
- [22] Bathe K. J., "The subspace Iteration Method-Revisited", *Int. J. of Computers and Structures* (2012).

SENSE OF PLACE IN AMITAV GHOSH'S THE HUNGRY TIDE: A CRITIQUE

Rekha Shukla¹, B.K. Sharma²

¹Research Scholar, Dept. of English Studies and Research
M.L.B. Govt. College of Excellence Gwalior (M.P)

²Professor, Dept. of English Studies and Research
M.L.B. Govt. College of Excellence Gwalior (M.P)

Amitav Ghosh's greatest gift as a writer may well be his sense of place. A landscape, a city, a village on the edge of a desert: it is these images that we summon from his novels when we are distanced from them in memory. Perhaps this is what makes him such a master of the travel narrative, a form whose contours are shaped by places and their histories. His most recent book, *The Hungry Tide*, is set in the Sundarbans, the vast, intermittently submerged archipelago, largely covered by mangrove forests, that forms the delta of the Ganges as it debouches into the Bay of Bengal. The region is supposed to derive its name from the sundari tree, as the mangrove is locally called; in his book, Ghosh speculates on whether the name may not more simply correspond to *sundar ban*, beautiful forest, as many prefer to believe. Two-thirds of the Sundarbans are in Bangladesh, only one-third in India: it is a region whose fishing folk easily traverse the imaginary boundaries of the modern nation-state, crossing, as the wind and the tides take them, the mouths of the many river-channels that set up a unique turbulence of fresh and salt water washing the islands of the archipelago.

To this land discovered by the ebb-tide, *bhatir desh*, as Ghosh calls it in a remarkable and poetic application of the term used in Mughal land-records, come a young cetologist from the United States on the trail of a breed of freshwater dolphin, the *Orcaella brevirostris*, and a middle-aged linguist who runs a translation bureau in Delhi. The two are thrown together by chance, and for a time the male translator, Kanai Dutt, accompanies the female scientist, Piya Roy, as an unofficial interpreter. But the novel is not really about their developing acquaintance.

Much more centrally and in a far more extended way, it is about the many histories of the region they have come to. Kanai's aunt Nilima has lived in one of the islands for years; she sends for him after the discovery of a diary belonging to her long-dead husband Nirmala, a Marxist schoolteacher whose withdrawal from political activism had brought them to settle in a Sundarbans village. As Kanai reads the diary, its narrative of past events, hopes and disappointments (held together as much by the inexorable flow of historical time as by Nirmal's constant evocation of lines from Rilke's *Duino Elegies*), is interwoven with other stories. These include Kanai's own memories of a visit he paid his uncle and aunt as a child, his present experiences as a guest at Nilima's hospital, and Piya's search, aided by the fisherman Fokir, for the *orcaella*.

At the heart of Nirmal's diary is an historical event: the eviction of refugee settlers from the island of *Morichjhapi* in the Sunderbans by the Left Front government of West Bengal in 1979. For the old Communist in the novel, like many others at the time, this act of state violence was a betrayal of everything left-wing politics in the post-Partition era had stood for. It was these very leftists who had declared, in the face of Dr Bidhan Chandra Roy's attempts to find land in neighbouring states for the successive waves of refugees who crossed over from East Pakistan in the forties and fifties, that they would not consent to a single one being resettled outside West Bengal. And indeed the conditions of such resettlement were harsh and alien. In 1978 a group of refugees fled from the *Dandakaranya* camp in Madhya Pradesh and came to the island of *Morichjhapi* in the Sundarbans with the

intention of settling there. They cleared the land for agriculture, and began to fish and farm. But their presence there alarmed the Left Front ministry, who saw it as the first of a possibly endless series of encroachments on protected forest land, and the settlers were evicted in a brutal display of state power in May, 1979. Many, like the girl Kusum in Ghosh's novel, Kanai's childhood playmate who becomes the repository of Nirmal's idealist hopes, were killed. Nirmal, who stays with the settlers during those final hours, is later discovered wandering in the port town of Canning; he is shattered by the event and never recovers. As the last significant expression of the trauma of Bengal's Partition, the story of Morichjhapi occupies a central place in the novel.

But it is only one of the histories - part fact, part fiction - that the Sundarbans of Ghosh's novel enfolds. There are others: the life cycle of the Orcaella, the story of its identification and the aquatic history of which it is part; the story of the port town of Canning, and the folly of its foundation by the British; the storms, named cyclones by the shipping inspector Henry Piddington, which ravage the region with irresistible ferocity; the visionary ambition of Sir Daniel Hamilton, who bought ten thousand acres of land in the Sundarbans and set out to build an ideal community; the tale of Bon Bibi and her worship, recounted in many folk epics, fusing Muslim and Hindu faith; and of course the present histories of Kanai, Nilima, Piya, Fokir, Fokir's wife Moyna and their son Tutul, among others. In a land regularly obliterated, at least in part, by the flood tide or by the huge tidal waves dredged up by cyclones (one of which marks the novel's climax), Ghosh makes us aware of the sedimentation of human history, the layers of past knowledge, experience and memory that constitute our human sense of place.

In our reading of such a work, characters may seem less important to us, appearing more as aspects of the places they occupy. Yet this would not be a true reflection of Ghosh's project in this novel. His sense of Bengali social history is, as always, unerring and profound. One of the most moving things in the novel is the textual tenor, at once perceptive and self-deceived, of Nirmal's diary, especially as it stands framed by the more robust and enduring social activism of his wife

Nilima, and by the common sense of his companion on his last journey, the fisherman Horen Naskor. To some extent the two visitors to these islands, Piya and Kanai, are thin-fleshed outsiders to the end, contributing much less by way of personal depth to the complicated tangle of genealogies and emotional and sexual history that makes up the plot. Yet their presence as focalizing centres is vital to the narrative: each, in her or his own way at once egotistic and work-obsessed, offers an opportunity to the narrator which Ghosh never fails to exploit.

Most remarkable is Ghosh's treatment of Kanai, a self-important, sometimes cocksure individual who ultimately becomes the locus of some of the novel's central reflections on language and on translation. It is through Kanai's translation, his mediating sensibility, that Nirmal's personal record, the Rilke that he reads in Buddhadeva Bose's Bangla translation, and the folk narrative of Bon Bibi that he writes down from Fokir's recitation, reach us, so the novel seems to claim, in English prose and verse. Some Bengali reviewers of *The Hungry Tide* have already asserted that their experience of reading it was like that of reading a novel in Bangla. This claim seems to me mistaken. Rather, the novel seems to push us into the crisis at the heart of translation, the paradox of representation itself. At one level, everything in the novel is translated, in that it seeks to represent, in English, a life, a culture, that is experienced principally through the medium of Bangla and its local variants. At another, nothing is: if representation is always a form of translation, one language is at any time as good as another - at most it may involve special difficulties that are also special opportunities. The one moment at which Kanai is robbed of the language that is his livelihood and his means of control is when, stranded on the mudbank, he sees the tiger. "The sounds and signs that had served, in combination, as the sluices between his mind and senses had collapsed: his mind was swamped by a flood of pure sensation." The meeting with the tiger, which may mean death or life, here as in the story of Dukhey and Dokkhin Rai, lies at that boundary of language which representation seeks, but never succeeds in containing.

Piya's scientific quest constitutes another pole of perception. Not that she is lacking a background:

she has a family history, which she recalls in moments of reflection, a present involvement with Fokir and Kanai, and a future, which she calmly claims at the novel's close. But it seems to me that her function in the novel is to represent the life she studies in the mingled waters, salt and sweet, of the tidal pool at Garjontala; the always-threatened, always-precious material of scientific enquiry which is also, in the fragile and immensely overburdened ecosystem of the Sundarbans, nature itself. She is by no means the novel's only conduit for reflections on the unique environment that affords her material for study. Nirmal, thinking of the necessity that compels the refugees to clear the forest and till the land on Morichjhāpi, as of the honey-collectors and woodcutters who go into the forest and are eaten by tigers and crocodiles, also asks a question central to the novel's concerns: whose is this land, nature's or man's? It is a question that cannot be answered, not even by the idealizing solution of co-existence. Piya is ultimately too practical and obsessive to bother with large answers; Nirmal is overcome by the very effort of posing the question.

It is the tone of the novel, alternately poetic, scientific and businesslike, that may suggest the nature of Ghosh's own thoughts on this subject. Beside the manifest threats posed by human settlement to the unique diversity of aquatic and terrestrial life in the mangrove swamps of the Sundarbans, beside the constant depletion of

aquatic species by fishing and trawling, there are equal dangers for the human settlers. Not only does the forest take its toll; the tides, too, exact their revenge. The constant erosion of dykes and embankments, the silting up of channels, the flooding by storm-waters, make human life on the islands no more, in the last analysis, than an accident or miracle. It was on such miracles that the hopes of visionaries like Daniel Hamilton or the settlers of Morichjhāpi were founded, and indeed there is no reason why human beings, like the many other species that uniquely inhabit this delta, should not serve to illustrate nature's capacity for survival. But the imminence of disaster, whether natural or human, covers the world of this novel with a kind of film by which "precious objects appear doomed and irrecoverable in the very moment of their perception", as Freud said in his essay *On Transience*. Its mood is elegiac, like that of the river novel in *Bangla*, as Bhaswati Chakravorty has named the form: but at the same time, it embodies the practical hope that leads us as human beings to continue to struggle and build on our doomed planet. Ghosh's critique of past and present mistakes, whether administrative or political, is at all times muted and restrained.

Works Cited

Ghosh, Amitav. *The Hungry Tide*, Noida, Harpor Coollins Publishers. 2004

EXPERIMENTAL INVESTIGATION OF 4 STROKE COMPRESSION IGNITION ENGINE BY USING DIESEL AND PROCESSED WASTE COOKING OIL BLEND

Neelesh Soni¹, Om Prakash Chaurasia²

¹Assistant Professor, Dept. of Mechanical Engg., Shri Ram College of Engineering & Management, Banmore, Gwalior (M.P)

²Professor & Head, Dept. of Mechanical Engg., NIT, Patna (Bihar)

Email:neeleshsoni7@gmail.com¹

Abstract

Due to future energy demand in the world it became necessary to focus on the alternatives of conventional fuel. To overcome this energy crisis it is also necessary to examine every aspect of performance of these substitutes in well manner so that they can fulfill the requirement of energy in an economic way. In this regard an experimental investigation of compression ignition engine have been carried out by using diesel and blend of biodiesel derived from waste cooking oil (WCO).

In the proposed work, waste cooking oil derived from hotels and restaurants has chemically processed in the laboratory of Delhi University. Chemical treatment included transesterification, phase separation and filtration of waste cooking oil. After preparation, the blends of waste cooking oil with diesel in different proportions such as B5, B10, B20, B40, B60, and B80 have investigated in CI engine in varying load conditions. On the basis of observations and calculated results, it has observed that engine was running successfully while using different blends of WCO biodiesel without any modification of engine and it has concluded that among all WCO biodiesel blends, the specific fuel consumption, brake specific fuel consumption and brake thermal efficiency of B20 is quite comparable to that of diesel for the power variation 0 watt to 3000 watt. The temperature of exhaust gas was minimum (110°C) for B20 blend.

Keywords: CI engine, Waste cooking oil, Transistification, blending

1. INTRODUCTION

Compression ignition engine a type of internal combustion engine which has been employed for power generation since several years. These engines are operated by using conventional fuels like diesel fuel and operated on diesel cycle which includes two isentropic process, one constant pressure process and one constant volume process.

Heat addition takes place at constant pressure process and rejection at constant volume process [1]. According to the current scenario of energy, sources of these conventional fuel are continuously depleting and need of energy is in extreme point so it become very necessary to investigate the alternatives of conventional fuel

and examine them to determine the utility of these alternatives [2].

In the particular context waste cooking oil derived from hotels and restaurants has considered as an alternative fuel which has been processed by transesterification and filtration to obtain the properties of fuel nearby diesel and made suitable for diesel engine [3]. After chemical treatment it has blended with diesel in different proportion such as B5, B10, B20, B40, B60 and B80. After preparation of blend they were investigated in single cylinder four stroke diesel engine by determining the parameters such as Specific fuel consumption, Brake specific fuel consumption, Brake thermal efficiency and exhaust gas temperature.

For successful proceeding of experiments, concerned literature has been reviewed. Balat et al. [4] presented economic factor to consider for input costs of biodiesel production is the feedstock, which about 80% of the total operating cost. Other important costs are labor, methanol and catalyst, which must be added to the feedstock. Using an estimated process cost, exclusive of feedstock cost, of US\$0.158/l for bio-diesel production, and estimating a feedstock cost of US\$0.539/l for refined soya oil, an overall cost of US\$0.70/l for the production of soy-based bio-diesel was estimate. Milind & Patil [5] represented the test results for blends 5% to 20%. For all fuel sample tested it is observed that with the loading of the engine at 2.138 kW. BTE of pure diesel and blend of diesel and ethanol was almost same. That of kerosene BTE was low compare with diesel and ethanol blend. For 20 % mixture of ethanol blend with diesel has a very good efficiency compared with pure diesel and blend of kerosene. Stalin and Prabhu [6] presented a review of the alternative technological methods that could be used to produce this fuel. Biodiesel from karanja oil was produced by alkali catalyzed transesterification process and results indicated that the dual fuel combination of B40 can be used in the diesel engines without making any engine modifications. The cost of dual fuel (B40) can be considerably reduced than pure diesel. Nantha et al. [7] described the energy and exergy analysis of a diesel engine integrated with a PCM (phase change material) based energy storage system, and provides more realistic and meaningful assessment than the conventional energy analysis.. It is observed through the analysis that 6.13% of the total energy of the fuel is saved using the TES system. From the exergy analysis, it is identified that only 0.47% of the chemical availability of the fuel is saved. The energy efficiency of the integrated system is found to be varying between 3.19% and 34.15%. In contrast, the energy efficiency, which incorporates the second law of thermodynamics for the integrated system, ranges from 0.25% to 27.41%. Singh and Rath [8] investigated the performance, emission and combustion characteristics of a diesel engine using different blends of methyl ester of karanja with mineral diesel. Karanja methyl ester was blended with diesel in proportions of 5%, to

100% by mass and studied under various load conditions in a compression ignition (diesel) engine. The exhaust gas temperature is found to increase with concentration of karanja methyl ester in the fuel blend due to coarse fuel spray formation and delayed combustion.

Jones et al. [9] indicated that vegetable oils can readily be used as a fuel source when the vegetable oils are used alone or are blended with diesel fuel. Long-term engine research shows that engine durability is questionable when fuel blends contain more than 20% vegetable oil by volume. More work is needed to determine if fuel blends containing less than 20% vegetable oil can be used successfully as diesel fuel extenders.

2. EXPERIMENTAL SETUP:



3. LISTS OF THE INGREDIENTS USED IN THE EXPERIMENT SETUP:

1. Foundation structure	2. Steel frame mountings
3. Internal combustion engine	4. AC alternator
5. Electrical Load panel	6. Temperature sensing device
7. Speedometer (Tachometer)	8. Air intake measurement system
9. Fuel intake measurement system	10. Diesel & WCO Biodiesel fuel

4. SPECIFICATION OF DIESEL ENGINE USED IN THE EXPERIMENT SETUP:

For conducting the experiments on CI engine a four stroke, single cylinder, vertical and water

cooled diesel engine has employed made from Kirloskar oil engine India. Engine have the compression Ratio 17.5:1, Stroke and Bore are 110 mm and 87.5 mm, rated power output 7.5 HP/5.2 KVA and rated RPM is 1500. Engine is hand start and direct injection type.

5. PROPERTIES OF DIESEL AND WCO BIODIESEL BLEND PREPARED FOR THE EXPERIMENT:

Properties of diesel and WCO biodiesel blends have explained in the table at annexure 1. That includes the specification of diesel and blends of waste cooking oil such as B5, B10, B20, B40, B60, B80 and B100.

6. EXPERIMENTAL METHODOLOGY:

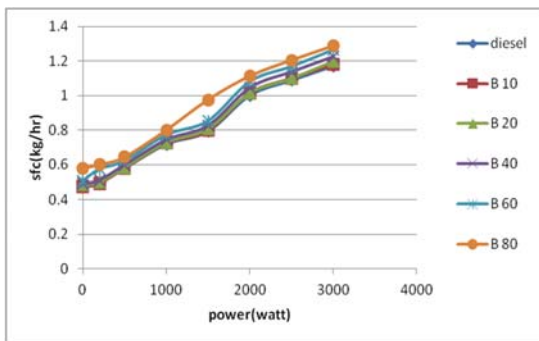
Conduction of the experiment on diesel engine by using diesel and WCO biodiesel blend included measurement of basic parameters like fuel consumption, RPM and temperature of exhaust gas while power varied from 0 watt to 3000 watt.

On the basis of this observation, parameters were calculated for diesel and different WCO biodiesel blend are specific fuel consumption, brake specific fuel consumption, brake thermal efficiency and exhaust gas temperature.

7. RESULTS AND DISCUSSION

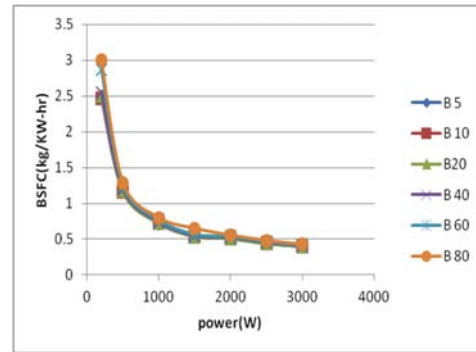
7.1 Variation specific fuel consumption with power for different blends:

It has been indicated by the graph that Specific fuel consumption was increasing when power increased on engine from 0 to 3000 kW for diesel and all biodiesel blends.



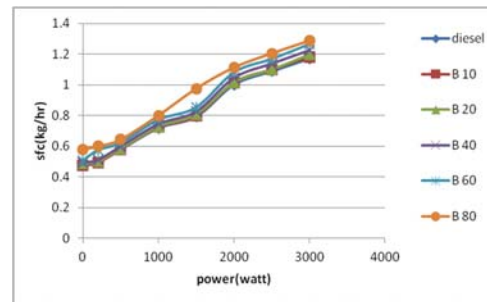
7.2 Variation of power with Brake specific fuel consumption (BSFC) for different biodiesel blends:

It has been indicated by the graph that brake specific fuel consumption was decreasing when power increased on engine from 0 to 3000 kW for diesel and all biodiesel blends.



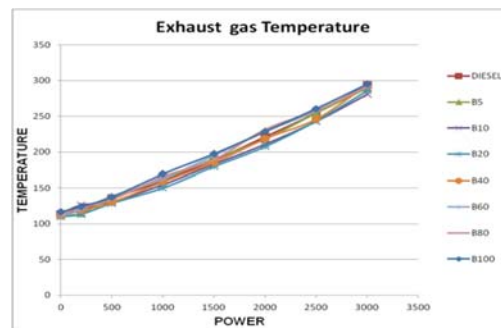
7.3 Variation of Power with Brake thermal efficiency (BTE) for different Biodiesel blends:

It has been indicated by the graph that Brake thermal efficiency was increasing when power increased on engine from 0 to 3000 kW for diesel and all biodiesel blends.



7.4 VARIATION OF TEMPERATURE EXHAUST GAS WITH POWER FOR DIESEL AND WCO BIODIESEL BLENDS

It has been indicated by the graph that exhaust gas temperature was increasing when power increased on engine from 0 to 3000 kW for diesel and all biodiesel blends.



8 CONCLUSIONS

After performing the successful experiment on CI engine by using diesel and various WCO

blends, following major conclusions have been drawn from the results obtained.

- The specific fuel consumption has found optimum for the blend B20 and nearby diesel fuel for the power variation 0 watt to 3000 watt.
- Among all WCO biodiesel blends, the brake specific fuel consumption and brake thermal efficiency of B20 is quite comparable to that of diesel for the power variation 0 watt to 3000 watt.
- The temperature of exhaust is minimum (110°C) for B20 blend and maximum (295°C) for B100 for the power variation 0 watt to 3000 watt.
- Hence blend B20 may be used in the diesel engine without any engine modifications.

REFERENCES

- [1] P. K. Nag, “Engineering Thermodynamics” Tata McGraw-Hill, Second edition, 2003,
- [2] <http://www.dieselpowermag.com>, cited on 11/2013.
- [3] Willard W. Pulkrabek, “Engineering fundamentals of the Internal Combustion Engine” PHI Learning New Delhi, second edition, 2010,
- [4] Mustafa Balat, Havva Balat, ‘A critical review of Biodiesel as a vehicular fuel’ A Journal of energy conversion and management, 2008, VOL. 49.
- [5] Milind, S., Patil, R., S., Jahagirdar, Eknath, R., Deore, “Performance Test of IC Engine Using Blends of Ethanol and Kerosene with Diesel” International Journal of Engineering Science and Technology, 2010, Vol. 2, 3503 – 3509.
- [6] N. Stalin and H., J., Prabhu., “Performance test of IC engine using Karanja Biodiesel and blending with Diesel” A Journal of Engineering and Applied Sciences, October 2007, ISSN 1819-6608. Vol 2, Issue 5.
- [7] K., Nantha, Rayapati Subbarao, V., Pandiyarajan and R. Velraj, ‘Thermodynamic analysis of a Diesel Engine Integrated with a PCM based energy storage system’ International journal of thermodynamics, March 2010, Vol.13 pp 15-21.
- [8] R.,K., Singh and Saswat, Rath, “Performance analysis of blend of the Karanja methyl ester in a Compression Ignition engine” International Conference on Biomedical Engineering and Technology, 2011, vol.11.
- [9] Sam Jones and Charles L. Peterson, “Using an Unmodified Vegetable Oils as a Diesel Fuel Extender” A Literature Review, University of Idaho, Moscow, Idaho.
- [10] Amit pal and S.S. Kachhwaha. ‘Waste cooking oil a promising feed stock for Biodiesel Production’ American Journal of science and technology, 2014.

ANNEXURE

1. SPECIFICATION OF DIFFERENT BIODIESEL BLEND PREPARED FOR THE EXPERIMENT-

Sn.	Fuel type	Proportion of fuel in Volume (ml)	Density (kg/m ³)
1	Pure Diesel	100% Diesel	831
2	B 5	5% WCO Biodiesel + 95% Diesel	833.78
3	B 10	10% WCO Biodiesel + 90% Diesel	836.5
4	B 20	20% WCO Biodiesel + 80% Diesel	842
5	B 40	40% WCO Biodiesel + 60% Diesel	853
6	B 60	60% WCO Biodiesel + 40% Diesel	864
7	B 80	80% WCO Biodiesel + 20% Diesel	875
8	B 100	100% WCO Biodiesel	886

2. COMPARATIVE SPECIFICATIONS OF DIESEL AND BIO DIESEL FUEL

Property	Unit	Acceptable limit	Diesel ASTM D975	WCO Biodiesel
a- Density at 15°C	Kg/m ³	860-900	831	886
b- Kinematic viscosity at 40°C	m ² /s	(3.5 - 5)×10 ⁻⁶	(2.5 - 6)×10 ⁻⁶	4.3×10 ⁻⁶
c- Flash point	°C	Min 100	51	>210
d- Sulphur contents	PPM	Max 350	500	<120
e- Water content	w/w%	0.02-0.05	0.005	>0.04
f- Calorific value	MJ/kg	...	42	36.34

DEVELOPMENT OF MULTIBAND ANTENNA USING METAMATERIAL

Sumit Nigam¹, Ashutosh Sharma²

¹PG Scholar, Bhagwant University, Ajmer

²Principal, Globus Engineering College, Bhopal

Email: nigamcnb11@gmail.com¹, ashuvidisha@gmail.com²

Abstract

In this paper the design of a multiband antenna by using a metamaterial structure is presented. Proposed antenna could operate in three different frequencies that are (1.941, 2.586 & 2.784) GHz. simulated results present here shows that the minimum return loss achieved is -22.4dB and maximum is -29.1dB on 2.786 and 1.941GHz respectively. The proposed antenna implemented on substrate called FR4 lossy with dielectric constant 4.3 and height 1.6mm. The designing and simulation work has been done on the CST-MWS software. To operate three different frequencies three antennas required, but by using a single cover of metamaterial the number of antennas reduced to one. i. e. instead of three a single antenna with incorporated metamaterial will be sufficient to operate on all three different frequencies.

Keyword: Negative Media (Metamaterial), Rectangular microstrip patch antenna (RMPA), return loss, multiband, directivity.

I. INTRODUCTION

Microstrip patch antenna design has become one of the greatest extent fields in the communication studies. In previous years when radio frequency was invented, not very high technique or compound design was used as a transducer to convert electrical energy into electromagnetic wave through the air in all direction. Feeder is significant elements in the RF system to receive or transmit the radio waves from and to the air. Rectangular microstrip patch antenna is one of the significant types of wireless antenna. The microstrip antenna has been the most innovative area in the antenna engineering, which is because of its low material cost (PCB) and its easiness of fabrication which the process can be made inside institutes. Wireless communications has been exponentially increasing in the cellular telephony, wireless Internet, and wireless home network. The wireless networks also include wireless local area networks (WLAN). The standard group for wireless LAN in IEEE is IEEE 802.11. In this

letter, design and simulation of RMPA alone at 2GHz has been elaborated, thereafter modification of that RMPA into a distinguished triple band microstrip antenna for wireless communication applications, which will be able to deliver power in 1.941, 2.586 & 2.784GHz. This significant transition shows that a single patch antenna with an implementation of negative media at the height of 3.276mm will be able to generate power in 3 different frequencies while driving by a single supply of operating frequency 2 GHz.

Initially V. G. Veselago presented theory about the negative media or metamaterial in late 60's. Veselago defined metamaterial as a material which physically not existed in social media but this artificial material produces a negative index of refraction. The theory presented by Veselago later used in many studies, one of them is microstrip patch antenna. In 21st century J. B. Pendry proposed split ring resonator concept, which was a typical design of metamaterial in antenna

designing. This split ring concept enhanced the antenna parameter such as bandwidth, return loss, directivity etc. Metamaterial also exhibit negative permittivity (ϵ) and permeability (μ) which gives it another name of negative media. In this letter its negative media property is used to prove the material used here to improve the parameters of RMPA is metamaterial.

II. DESIGN SECTION

All the designing and simulation technique is used to prepare this letter has been done on the computer simulation technology microwave studio (CST-MWS). The proving of material which modifies the single band antenna into triple band antenna has been processed in MS Excel software. Microsoft paint software was used to show the dimension in patch and metamaterial design. First of all dimension of patch antenna was calculated from formulas given below for the operating frequency of 2 GHz. Substrate used was FR4 lossy which has dielectric constant of 4.3 and height 1.6mm.

$$W = \frac{1}{2f_r\sqrt{\mu_0\epsilon_0}}\sqrt{\frac{2}{\epsilon_r+1}} = \frac{C}{2f_r}\sqrt{\frac{2}{\epsilon_r+1}} \quad \dots (1)$$

$$L = L_{eff} - 2\Delta L \quad \dots (2)$$

Where,

$$L_{eff} = \frac{C}{2f_r\sqrt{\epsilon_{eff}}} \quad \dots (3)$$

$$\frac{\Delta L}{h} = 0.412 \frac{(\epsilon_{eff}+0.3)\left(\frac{w}{h}+0.264\right)}{(\epsilon_{eff}-0.258)\left(\frac{w}{h}+0.8\right)} \quad \dots (4)$$

$$\epsilon_{eff} = \frac{\epsilon_r+1}{2} + \frac{\epsilon_r-1}{2} \left(\frac{1}{\sqrt{1+\frac{12h}{w}}} \right) \quad \dots (5)$$

In above used formulas the symbols have their usual meanings.

e.g.

- c = Velocity of light in free space,
- ϵ_r = Substrate's Dielectric constant,
- ϵ_{eff} = Effective dielectric constant,
- L= Actual length of the patch,
- W= Width of the patch.

After calculation of dimensions, rectangular microstrip patch antenna was designed on previously indicated software. Length and

width of the proposed RMPA were calculated by using above listed formulas, and the designed RMPA is shown in figure 1. The simulated result of the patch in figure 1 is shown in figure 2 which show the comparative graph of return loss in dB and frequency in GHz. Simulated result of patch at 2 GHz shows return loss of -10.11dB and bandwidth of 9.4MHz.

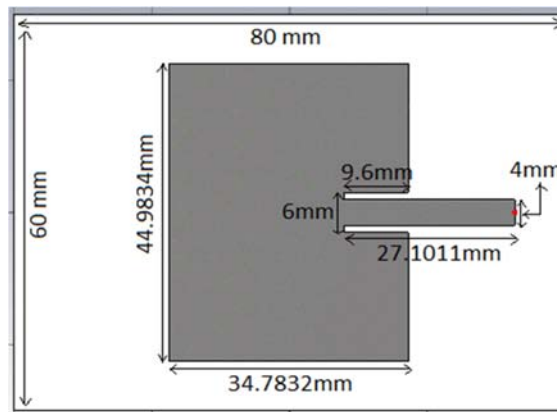


Figure 1: RMPA at 2 GHz.

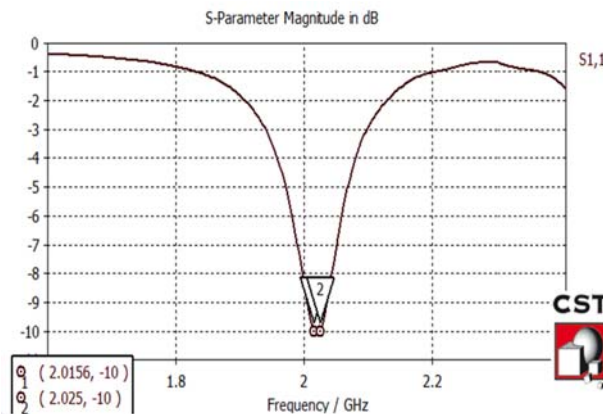


Figure 2: Simulated result of RMPA shown in figure 1

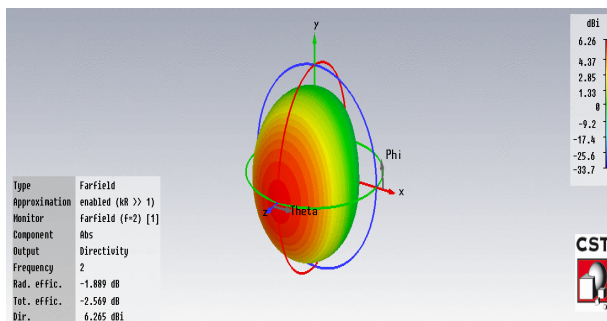


Figure 3: Simulated result of RMPA showing directivity of 6.265dBi and efficiency of 55.3% with radiation pattern of respected patch.

After patch analysis it comes out that the RMPA is not showing good enough result to

use at a standard level, therefore metamaterial cover was implemented over patch shown in figure 1. This metamaterial implementation modifies the antenna parameters to a great extent. e.g. single band antenna converted into triple band antenna, bandwidth of all three dips also increased than the bandwidth of RMPA alone, efficiency also increased than later. The negative media design which modifies the patch parameter is shown in figure 4 and simulated results of the respected design for all three operating frequency are shown sequentially in figure 4, 5, 6, 7 and 8.

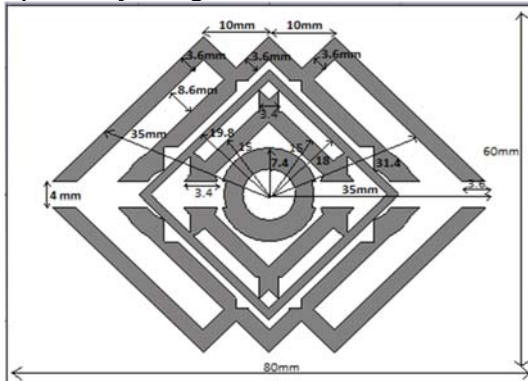


Figure 4: Proposed metamaterial design at the height of 3.2mm from ground.

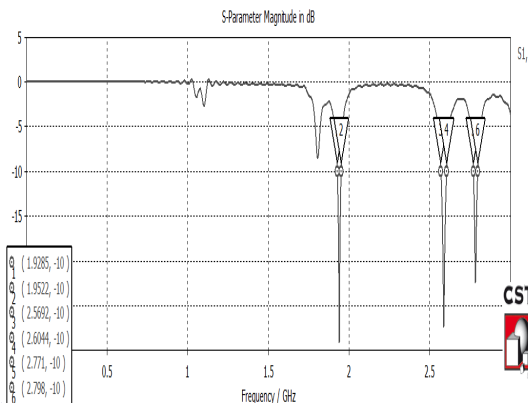


Figure 5: This is the simulated result of design in figure 4, showing 3 dips at 1.941, 2.586 & 2.784. The value of return loss and bandwidth was introduced before.

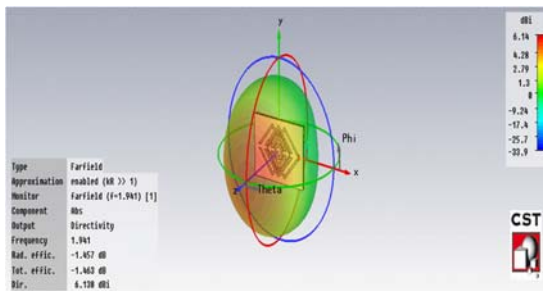


Figure 6: Radiation pattern at frequency 1.941 GHz having directivity 6.138dbi and efficiency 71.4%.

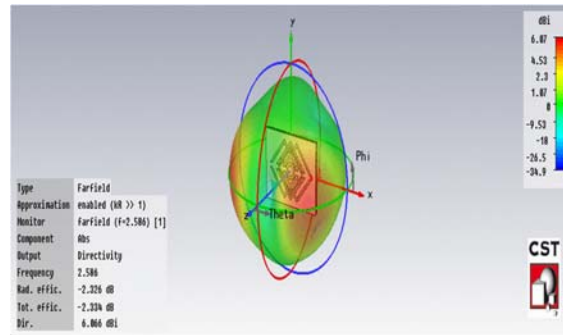


Figure 7: Radiation pattern at frequency 2.586 GHz having directivity 6.066dbi and efficiency 58.4%.

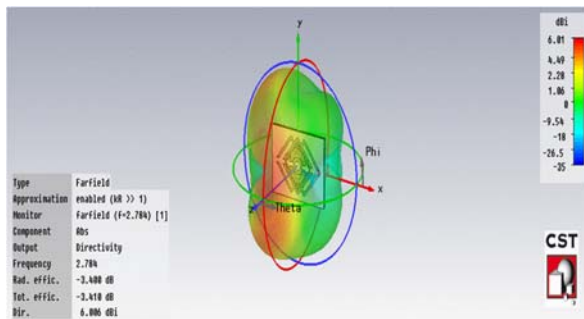


Figure 8: Radiation pattern at frequency 2.784 GHz having directivity 6.006dbi and efficiency 45.6%.

It has been observed by comparing these results with simulated result of RMPA alone that there is dramatic increment in return loss, bandwidth, and efficiency. Directivity remains unaffected with slight variation, which is bearable. Comparative chart is shown below in table 1.

Table 1: Comparison chart.

s. no.	Parameters	RMPA alone at 2 GHz	After metamaterial introduction at 1.941GHz	at 2.586 GHz	at 2.784 GHz
1	Return loss	-10.1 dB	-29.1 dB	-27.3 dB	-22.4 dB
2	Bandwidth	9.4 MHz	23.7 MHz	35.2 MHz	27 MHz

3	Directivity	6.26 5dBi	6.138d Bi	6.066 dBi	6.006 dBi
4	Efficiency	55.3 %	71.4%	58.4 %	45.6 %

After the comparison it has been observed that there were many modifications occur by implementing a metallic design cover over the patch antenna. Now it had to be prove that weather it was metamaterial or not. For that purpose Nicolson ross weir (NRW) approach was used. In that approach structured design placed between two waveguide ports on X-axis in respect to calculate S11 and S21. Y and Z plane were defined as perfect electric and magnetic boundary respectively. After arrangement, wave excited from left to right to get S parameters. Later these S parameters were imported into the Microsoft excel software for further calculation. In Microsoft excel below formulas were used to get negative permittivity and permeability. These below formulas belong to NRW approach.

$$\mu_r = \frac{2.c(1-v_2)}{\omega.d.i(1+v_2)} \dots (6)$$

$$\epsilon_r = \mu_r + \frac{2.S_{11}.c.i}{\omega.d} \dots (7)$$

Where,

$V_2 = S_{21} - S_{11}$

$\omega =$ Frequency in Radian,

$d =$ Thickness of the Substrate,

$c =$ Speed of Light,

$V_2 =$ Voltage Minima.

$\mu_r =$ Relative permeability

$\epsilon_r =$ Relative permittivity

In below figures graph of negative permittivity and permeability are shown, which are result of NRW approach.

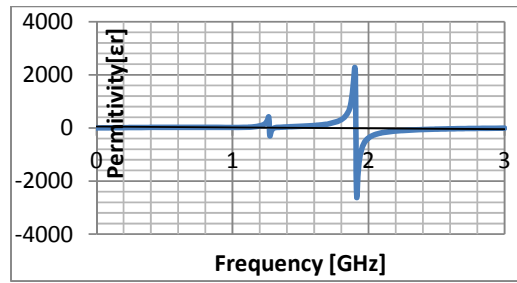
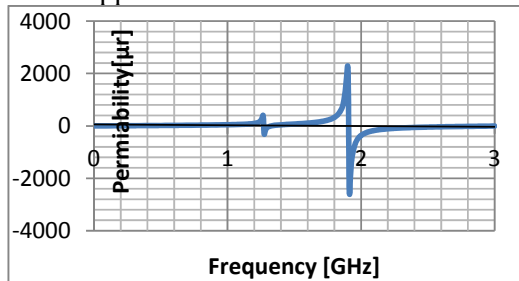


Figure 9: (a) Negative value of permeability at operating frequencies. (b) Negative value of permittivity at operating frequencies.

III. CONCLUSION

The designed antenna could be used in wireless communication for L band and even for S band. By applying frequency of 2 GHz it will be able to operate power in three different frequencies with low return loss, large bandwidth and more efficiently. This proposed design by authors can reduced the number of antennas required, because a single antenna can work in place of three distinguished antennas. It also been proved that the cover used to enhance the antenna parameter is metamaterial by using NRW approach.

IV. REFERENCES

Balanis CA (1997). *Antenna Theory and Design*. John Wiley & Sons, Inc.

Pozar DM (2004). *Microwave Engineering*, 3rd Edition. John Wiley & Sons.

Veselago VG (1968). *The electrodynamics of substances with simultaneously negative value ϵ and μ* . Sov. Phys. Uspeky. 10 (4), 509-514.

Pendry JB (2000). *Negative refraction males a prefect lens*. Phys Rev Lett, 85, 3966–396.

Lee Y, Tse S, Hao Y, and Parini CG (2007). *A compact microstrip antenna with improved bandwidth using complementary split-ring resonator (CSRR) loading*. in IEEE Int. Symp. Ant. and Prop. and URSI Radio Science Meeting Dig., pp. 5431–5434.

Singhal PK, Garg B (2012). *Design and Characterization of Compact Microstrip Patch Antenna Using “Split Ring” Shaped Metamaterial Structure*. IJECE, Vol.2, No.5, pp. 655~662.

Kwon Y, moon J, Park S (2003). *An internal triple-band planner inverted F antenna*.

EFFECTS OF GENDER ON THE PRODUCTION OF VOWEL DURATION IN YEMENI ARABIC DIALECTS: AN ACOUSTIC STUDY

Aisha Saleh Ali Mohdar

PhD Scholar, Linguistics and Phonetics Dept., The EFL University, Hyderabad

Email: aishamohdar@gmail.com

Abstract

The present study investigates the effect of gender on the production of vowel duration in three Yemeni Arabic dialects: Abyani Yemeni Arabic (AYA), Hadhrami Yemeni Arabic (HYA) and Ta'izzi Yemeni Arabic (TYA). A read speech data which consists of monosyllabic words (CVVC and their short counterparts CVC) was collected from 4 female and 4 male Yemeni Arabic speakers per dialect and was analyzed to see whether or not the duration of the vowels is symmetrical in both groups (i.e., female and male speakers). An automated script was used to measure the duration of the vowels. The results of the duration plots show that the female speakers of all the three Yemeni Arabic dialects produce vowels with longer durations than male speakers do.

In order to determine whether the vowel duration was significant within the female and male speakers of the three Yemeni Arabic dialects, a one-way ANOVA test was done. Results of the test suggest that there is a very highly significant difference ($p < .000^{***}$) in the female speakers vowel duration compared to the male ones in all the three Yemeni Arabic dialects. Based on the results, the null hypothesis that there is no significant difference between the duration of the vowels in both groups (females vs. males) is rejected. Thus, there is strong evidence of a mean increase in females' vowel duration compared to the male ones.

Index terms: Acoustic Analysis, Arabic, Gender, and Vowel duration.

I. Introduction

Some previous studies reported that gender affects speech rate while some other studies reported that gender does not affect speech rate. A study of a read speech data of 630 male and female American English speakers reported that female American English speakers use longer durations than male speakers [2]. Another acoustic investigation by Simpson on sex-differences reported that the duration of the vowels for German and American English female speakers was longer than the male speakers in both spontaneous and read speech (cited in [3]). In study aimed at investigating gender duration patterns (5 males and 5 females) in Swedish [3] showed that female speakers used vowels with longer durations than male speakers in stressed syllables, but this is not found in

unstressed vowel tokens (i.e., the female speakers used similar or shorter vowel durations).

Another acoustic investigation of three American dialects [5] reported that the effect of gender was not significant in the three American dialects, although the mean values of female speakers' vowel duration were slightly longer than male speakers' vowel duration (168 ms vs. 160 ms). An investigation on gender specific duration patterns in Creek [6] reported that durational patterns also exist in non-Indo-European languages and the females produced longer durational differences between long and short vowels. Another study [8] examined gender-specific differences of 48 speakers of

American English and 9 speakers of Central Standard Swedish reported that longer vowel duration for female speakers was found for the stressed vowels but this was not the case in unstressed position.

An investigation of a sociophonetic study [9] with an acoustic examination of the vowel system of Jamaican Creole-dominant and Jamaican English-dominant speakers reported that female speakers in both groups used longer vowel duration within short and long vowels than the male speakers do. Furthermore, a study of 3 male and 3 female British English speakers [10] concluded that there are more pauses, more final lengthening, longer sentence durations, fewer vowel reductions and elisions, and a slower speaking rate for the female than male speakers. A recent study of African American English (AAE) and White American English (WAE) speakers [11] showed that vowel duration produced by female speakers for both AAE and WAE were significantly longer than male speakers.

In the first section (Introduction), I review the most relevant work that has been done on gender durational differences across languages and dialects. In the second section (methods), I show the methodology of the study and design. And the last section shows the results and discussion. The discussion situates the findings of the study in the context of previous researches on the topic. I then note how gender has an impact on vowel duration among the three Yemeni Arabic Dialects. Finally, I close the study with a conclusion on the effect of gender on the vowel duration.

II. Methods

A. Speakers

The speakers are 8 native speakers of Yemeni Arabic per dialect i.e four females and four males. The eight speakers per dialect are in their twenties and thirties with no history of hearing and speech impairment. They participated in the experiment without any payment.

B. Speech Material

The material consisted of 18 randomized monosyllabic words with either /CVn/ or /CVVn/. The syllable initial consonant was one of the three stop consonants /b/, /d/ or /g/ and the

syllable middle was one of the six vowels /i:/, /i/, /u:/, /u/, /a:/ or /a/ followed by the nasal consonant /n/. The material embedded in a carrier sentence: *katab <word> thalaath maraat*. Not all of the target words were real Yemeni Arabic monosyllabic words CVC and CVVC. All materials were presented to the speakers in Arabic script (right to left).

Consonant		[b]	[d]	[g]
No.	vowel			
V1	[i]	[bin]	[din]	[gin]
V2	[i:]	[bi:n]	[di:n]	[gi:n]
V3	[u]	[bun]	[dun]	[gun]
V4	[u:]	[bu:n]	[du:n]	[gu:n]
V5	[a]	[ban]	[dan]	[gan]
V6	[a:]	[ba:n]	[da:n]	[ga:n]

Table 1: A list of real and nonsense words used to elicit gender vowel duration of three Yemeni Arabic Dialects

C. Recording Procedure

All recordings were recorded in a sound-treated room in the phonetics laboratory at the English and Foreign Languages University, using a CSL4200 with a Shure condenser microphone SM 48 placed at one inch distance from the speaker’s lips. Speakers read a list of randomized monosyllabic words embedded in a carrier sentence: *katab <word> thalaath maraat* (he wrote <word> three times). Each sentence was recorded three times. A total of 54 sentences were obtained from each speaker for subsequent acoustic analysis (6 vowels x 3 consonantal contexts x3 repetitions). The stimulus was presented to the speakers in a Sony laptop “14inches” and then the recordings were transferred to the same laptop via DVD. Each speaker was instructed to read the sentences at normal speech rate.

D. Acoustic Measurements

An acoustic experiment was designed to measure the duration of the vowels from the female and male Yemeni speakers using Praat version 5.4.04 [1]. The beginning and end of each vowel of interest was manually segmented and labelled. The duration of the vowels was measured automatically from the onset to the offset of the vowel. A sample waveform and a spectrogram of speaker one of TYA saying ‘*katab daan thalaath maraat*’ is given in below:

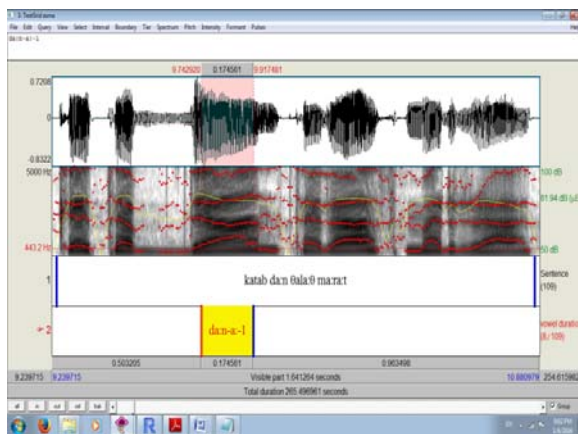


Figure 1: Waveform and spectrogram of TYA native speaker saying the word [da:n]

D. Statistical analysis

In order to determine whether or not the vowel duration was significant within the female and male speakers of the three Yemeni Arabic dialects, a one-way ANOVA test was done. The statistical analysis was done in R software version 3.2.1 [7]. Vowel duration data were plotted using *ggplot2* package [4] to decide whether or not gender affects the production of vowel duration in the Yemeni Arabic dialects.

E. Research questions

1. Do the female and male Yemeni Arabic speakers produce the same vowel duration per dialect?
2. Do the female and male Yemeni Arabic speakers produce the same speech rate among the Yemeni Arabic Dialects?

F. Research hypotheses

1. Female and male Yemeni Arabic speakers produce symmetrical vowel duration.
2. There will be no significant difference in the vowel duration between the female and male speech rate per dialect.

III. Results and Discussion

The results of the vowel duration of all the vowel tokens for both groups (females and males) of the three Yemeni Arabic Dialects are shown in (table 1). The following table (table 1) shows a summary of the mean vowel duration in AYA, TYA and HYA. The results indicate that there is a relationship between speech tempo and vowel duration within the same gender. The reason is that female speakers speak slower and this leads

to use higher vowel duration compared to the speech tempo of the male speakers who speak faster and this leads to producing shorter vowel duration in all the three Yemeni Arabic Dialects.

Gender	vowel duration	Dialect		
		AYA	HYA	TYA
Female	vowel duration	116.4	122.3	128.4
Male	vowel duration	97.1	102.0	110.2

Table 1: The mean values of the vowel duration of the three Yemeni Arabic Dialects

The following figure (fig.1) shows the females' and males' vowel duration in the Yemeni Arabic Dialects range in the following order: HYA, AYA and TYA. The values of the vowel duration in all groups are plotted in (Fig. 1). The results of duration data were plotted using *ggplot2* package [4]. The plots below show that the female speakers of all the three Yemeni Arabic dialects produce vowels with longer durations than male speakers do.

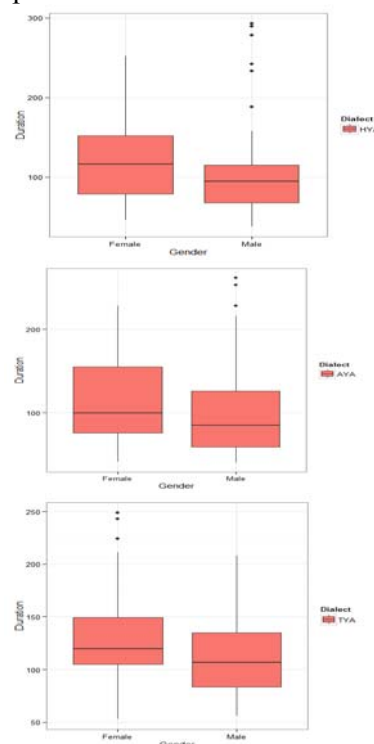


Figure 1: Females' and Males' vowel duration of Yemeni Arabic Dialects

Results of the one-way ANOVA test show significant main effect of gender on all the three Yemeni Arabic Dialects. A comparison of the mean values of females' and males' vowel duration in AYA reveals that there is a very

highly significant difference [$F(1, 430) = 19.26; p < .000^{***}$] in both groups. HYA data also shows that there is a very highly significant effect of gender on vowel duration [$F(1, 430) = 18.02; p < .000^{***}$] with male speakers. Moreover, there is a very highly significant difference in the duration of the female-male values in TYA [$F(1, 430) = 31.45; p < .000^{***}$]. The data reveals several points of interest. First, Vowel duration is longer in the female speech than in male speech and this is compatible with the previous studies. This means that the female speakers of the three Yemeni Arabic Dialects have smaller vocal tract than the male ones or tend to use a slow speech rate. It cannot be generalized that all the Yemeni Arabic female speakers have smaller vocal tract compared to the male speakers. Thus, it can be concluded that higher vowel duration in females' speech is because of slow speech rate. Moreover, it could be predicted that there are some other factors such as personality, age and dialect. Of particular interest to this article, there are differences in vowel duration among the three Yemeni dialects. In TYA, female and male native speakers used higher vowel durations compared to the other Yemeni Arabic dialects (HYA and AYA).

IV. Conclusion

The results have shown the effect of gender in female-male vowel duration in the three Yemeni Arabic dialects. The P-value is very low in all the three Yemeni Arabic dialects and this indicates that a very highly significant difference in the vowel duration of the female-male values per dialect ($p < .000^{***}$). To sum up, the results state that the differences in the mean values are highly significant between female-male vowel durations of the above-mentioned Yemeni Arabic dialects.

V. References

- [1] Boersma, Paul & Weenink, David. 2014. *Praat: doing phonetics by computer [Computer program]*. Version 5.4.04, retrieved 28 December 2014, <http://www.praat.org/>.
- [2] Byrd, Dani. 1992. Preliminary results on speaker-dependent variation in the TIMIT database, *Journal of the Acoustical Society of America*, **92**: 593–596.
- [3] Ericsson, Christine and Ericsson, Anna. 2001. Gender differences in vowel duration in read Swedish, *Working Papers of the Department of Linguistics, the XIVth Swedish Phonetics Conference*, Lund University, **49**: 34–37.
- [4] Wickham, Hadley. 2009. *ggplot2: Elegant Graphics for Data Analysis*, Springer, Dordrecht Heidelberg London New York.
- [5] Jacewicz, Ewa, Fox Robert and Salmons, Joseph. 2007. Vowel Duration in Three American English Dialects, *AM Speech*, **82**(4): 367–385.
- [6] Johnson, Keith. & Martin, Jack. 2001. Acoustic vowel reduction in Creek: effects of distinctive length and position in the word, *Phonetica*, **58**: 81–102.
- [7] R Core Team. 2015. R: A language and environment for statistical computing. R Foundation for Statistical Computing (version 3.2.1), Vienna, Austria. <http://www.R-project.org>.
- [8] Simpson, Adrian and Ericsson, Christine. 2003. Sex-specific durational differences in English and Swedish, *15th International Congress of Phonetic Sciences*, Barcelona.
- [9] Wassink, Alicia. 1999. *A Sociophonetic Analysis of Jamaican Vowels*, PhD Dissertation, University of Michigan.
- [10] Whiteside, Sandra. 1986. Temporal-based acoustic-phonetic patterns in read speech: Some evidence for speaker sex differences. *Journal of the International Phonetic Association* **26**: 23–40.
- [11] Holt, Yolanda, Jacewicz Ewa and Fox Robert. 2015. Variation in vowel duration among Southern African American English Speakers, *American Journal 460 of Speech-Language Pathology*, **24** : 460–469.

ANALYSIS OF MOISTURE SENSOR BASED ON MICROSTRIP PATCH ANTENNA: A REVIEW

Sweety Jain¹, Pankaj Kumar Mishra², Vandana Vikas Thakare³

¹Phd Scholar, Department of Electronics, ASET, Amity University, Gwalior (M.P)

²Assistant professor, Department of Applied Physics, ASET, Amity University, Gwalior (M.P)

³Associate Professor, Department of Electronics, MITS, Gwalior (M.P)

Email:1502sweety@gmail.com¹, pmishra@gwa.amity.edu², monika894@gmail.com³

Abstract

The paper summarize that moisture sensor based on microstrip patch antenna. Microstrip patch sensors have become useful and widely used in every fields such as agricultures, industrials, food products, medicals communication etc. It have been more useful for detecting i.e., broken rice detection, Impurities detection in water, Soil moisture measurement, Rice Grain moisture, Rice quality detection, etc. The Moisture sensors have been used for detecting the soil moisture, cereals moisture, which is useful for human beings. It had been analyzed by CST software and for measuring by the vector network analyzer.

Index Terms: Moisture content, Printed circuitry board, Vector network analyzer, CST software.

I. INTRODUCTION

Moisture sensor techniques have found many applications such as for detecting rice moisture, grain moisture, soil moisture, fruit moisture etc. Rice is an important nutrition for human beings especially for Asiatic population [1]. It provides minerals, vitamins, fiber etc. The quality of rice, moisture content & broken rice percent can be determined by microstrip patch sensor. The moisture levels were measured by the sensors based on resonance frequency & discussed the moisture content and relative complex permittivity measurements.

Now days, diseases are increasing day by day & affecting the human health such as food poison, liver failure etc. due to excessive intake of food products that highly contains of impurities. Some techniques have been proposed to detect the impurities in the food products [2] using the microwave measurement techniques.

Many people are suffering from sleep apnea syndrome which is respiratory problem. Due to the problem, increase the chances of accidents during the driving [3].

The patch array antenna was proposed as a non-contact sensor to detect respiratory movement. The sensor is also being demanding for ambulatory cardiac monitoring [4]. Such as patient monitoring, physical therapy, sports-fitness training etc & long term monitoring of various chronic health conditions so, it have been also proposed as a wearable sensor which was based on a microwave Doppler techniques. It was directly measured the heart beat.

It also has become widely used in fruits moisture which is very useful for human beings who get the vitamins, proteins, carbohydrates, etc which is very important role in blood coagulation, cancer etc [5].

II. PRINCIPLE OF OPERATION

Microstrip patch antenna consists of three components: a ground plane, a substrate, and a radiation patch [6] and can be used the different types of substrate i.e., RT Duroid, FR4, TLY-5, etc.

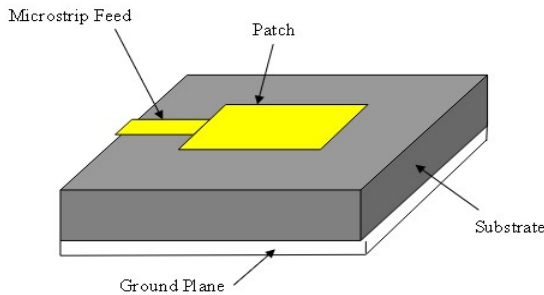


Fig.1: Microstrip configuration

Microstrip patch antennas radiate primarily because of the fringing fields between the patch edge and the ground plane [7].

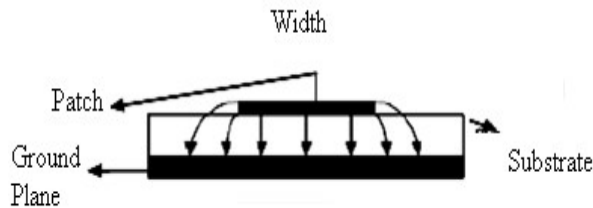


Fig. 2 Electromagnetic wave fringing from the top patch into the substrate

According to design of patch sensor calculated the dimensions of parameters and shape i.e., rectangular, circular, square, triangular, etc. and using the formula [6-7] & designed by the CST software [8].

III. Moisture measurement methods

Many different types of the moisture measurement method were used such as evaporation method, chemical reaction method, gas production method, etc. These were very cheap and easy to use but some drawback from these method i.e., time consuming as well as energy consuming which was very destructive [9]. One method was spectroscopic method which determined the microwave techniques. The techniques was very useful as well as widely used in many fields and it had become boom for human beings also because it was used for a moisture sensing for a long time for food products as well as suitable for real time monitoring and control.

An approach was proposed to find the moisture content in fruits by using the free space technique. The free space technique was useful to find moisture content and it was used for measure the dielectric properties of moist popular materials at microwave frequencies. It was very useful in terms of non-destructive and non

contact measurement of the moisture content. But here is one drawback it was so bulky. After drawback proposed the planar resonators which used the ring structure. The ring structure was measured the complex permittivity which was widely used in agricultures fields as well as used for rice quality detection [10]. It was neither the bulky nor destructive.

The complex permittivity was essential parameters to find the moisture content of cereals. Complex permittivity technique was classified into transmission reflection and resonance techniques. Some of the grain moisture determined with the lack of complex permittivity by using the transmission technique the main drawback of this technique it was operated at higher frequencies 9GHz-10GHz with the higher cost of microwave components. On the other hand a resonance technique was measured accurately low loss material with a low loss factor as compared to transmission reflection.

The one more parameter was used to find the moisture content in cereals i.e., insertion loss. Insertion loss is the loss of signal power it means when signal is transmitted with high insertion power the transmitted signal will become very low. Due to the low transmitted signal some of the low cost measurement devices are unable to detect the transmitted signal.

IV. Sensor Configuration

The sensors have been designed with different shapes for complex permittivity measurement at desired frequency as well as designed with resonators such as minkowski fractal resonator, fractal resonator, multi split ring resonators (SRRs) etc .It was etched using the different substrates FR4, RT/Duroid 5880 etc and designed simulate using the CST software for an operate of different frequency ranges. It was performed at 50Ω coaxial cable and measured by the vector network analyzer. The vector network analyzer was used to measure the transmission parameter S₁₂ of the sensor with and without at the desired frequency.

The different types of the moisture content in percentage as given below-

- The relative moisture content of sample, in percentage dry basis and wet basis as:

$$m.c (\%) = (m_w / m_w + m_d) * 100$$

Where, m_w and m_d are the mass of water and weight of dry cereals or the clod.

- The high moisture content M on a dry weight basis as:

$$M = (W_w / W_d) * 100$$

Where W_w and W_d are the masses of water and dry materials respectively.

- The moisture content MC using the weight of sample before dry and after dry as:

$$MC (\%) = (m_{\text{Before_Dry}} - m_{\text{After_Dry}} / m_{\text{Before_Dry}}) * 100$$

V. APPLICATION EXAMPLES

The antenna sensors were widely used in agricultures fields, food products etc. which is very useful for human beings due to the impurities of food products or the cereals diseases are increasing day by day It have been detected with the help of microstrip moisture sensor. Some applications are given below –

- Microstrip patch sensor has been designed for high moisture content which was used in production area [11] i.e., tea leaves with the help of sensor detected the leaves moisture content in the range from 190% to 350% on a dry wet basis by using the microwave transmission line technique.
- Microstrip ring sensors and microstrip coupled line sensors were designed for grain moisture content which is very useful for human beings. It was designed for low insertion loss and proper transmitted the signal as well as non destructive. The complex permittivity measured with a different moisture levels by using the resonance techniques. It can be applied with different application such as latex.
- Microstrip fractal resonator sensors have been designed for food products such as cardamom. It is the part of food which is the queen of the food. It was operated for non-destructive and applications in industry by using the microwave sensor. The uniqueness of this structure is reduced the area.
- The microstrip patch sensor designed for moisture content in soil [12]. It was designed compact and low cost rectangular patch antenna as a sensor for real time agriculture measurements. It was fabricated on FR4 printed circuit

board at frequency from 1.5GHz to 3GHz.

VI. CONCLUSION

The sensors have been designed, tested and fabricated compact as well as used to at desired frequency. In the present era microstrip patch antenna as a sensor have become boom in terms of moisture which is almost used for detecting the cereals moisture as well as used different fields. It will be more focused on some parameters i.e., small in size, easy to install, durable, low cost & more accurate. It will be a great potential to benefit many application as well as useful for human beings.

VII. REFERENCES

- [1] Hou kit mun, Kok yeow you, Mohamad Ngasri Dimon “Rice grain moisture determination using microstrip wide ring & microstrip coupled line sensors” AJAP, pp 112-120, 2015.
- [2] E.M.Cheng, M.Fraq, Shahrman A.B.,Mohd Afendi R., Y.S.Lee, S.F.KHOR, W.H.Tan, Nashrul Fazli M.N., A.Z.Abdullah ,M.A.Jusoh “Development of microstrip patch antenna sensing system for salinity & sugar detection in water” IJMME vol 14,no.5, pp 31-36, Oct 2014.
- [3] Jumpei Yonebayashi, Kazuyuki Saito, Masaharu Takahashi, Koichi Ito, “Patch array antenna for non-contact sensor to detect respiratory movement”, IEEE, 2011.
- [4] Richard R.Fletcher, Sarang Kulkarni, “Clip on wireless wearable microwave sensor for ambulatory cardiac monitoring”32nd annual international conference of the IEEE EMBS Buenos Aires, Argentina, 31staug-4thsep, 2010.
- [5] You Kok Yeow, Zulkifly Abbas1, Kaida Khalid, “Application of microwave moisture sensor for determination of oil palm fruits ripeness”, measurement science review, vol.10,no.1,pp 7-14,2010
- [6] John D.Krauss, “Antenna & Propagation”, Mc Graw –Hill international Editions, 2 editions 1988.
- [7] C. A. Balanis, “Antenna Theory” Analysis and Design 3rd edition, John Wiley & Sons, Inc., 2005.
- [8] CST “Computer studio site” Simulation Software microwave studio 2010.

- [9] Beulah Jackson, 2T. Jayanthi, “Moisture Content Determination Using Microstrip Fractal Resonator Sensor” Research Journal of Applied Sciences, Engineering and Technology, pp 2994-2997, 2014.
- [10] Dinesh kumar singh, Prateek kumar, Naved zafar rizvi, “Microstrip transmission line sensor for rice quality detection” IJERGS, vol.2, issue 4, pp 589-598, June-July 2014.
- [11] Yangjun Zhang and Seichi Okamura “A Density-Independent method for high moisture content measurement using a microstrip transmission line”, journal of microwave power & electromagnetic energy, vol.40, no.2, 2006.
- [12] K.Y.You, J.salleh, Z.Abbas, L.L.You “ A rectangular patch antenna technique for the determination of moisture content soil” PIERS proceedings, Cambridge, USA, pp 850-854, 5-8 July 2015.

REVIEW ON LEASE SCHEDULING IN HAIZEA FOR IAAS CLOUD

Aarti Vig¹, Ritika Keswani²

¹PG Scholar, Dept. of CSE, Institute of Technology & Management, Gwalior (M.P)

²Assistant Professor, Dept. of CSE, IPS-CTM, Gwalior (M.P)

Email: sweetyaarti.vig@gmail.com¹, ritika.keswani12@gmail.com²

Abstract

Cloud Computing is the technique of dynamic virtual provisioning of computing resources like processing power, storage, networking and Information Technology infrastructure through the Internet on pay per use basis from service providers. Customers can request for resources on the cloud from anywhere on the planet, by sending Lease through Internet to cloud service provider. Leases are resource provisioning abstraction which contains all required resources, the provisioning time of those resources, budget of customer etc. in terms of number of nodes, capacity of nodes, and duration of nodes. The service provider, then accepts all leases coming from customers, creates virtual machines for them, schedules those virtual machines, with the help of a lease manager. Lease manager make use of their algorithms for lease management, which also includes scheduling of leases. Haizea is an open-source virtual machine based lease management software. It allows user to send request in the form of leases. The algorithm which haizea make use of to search resources in its sample database is based on linear search. The time complexity of linear search algorithm to search a list of n elements is n. Since IaaS service provider at global level have extremely large number of resource in their datacenter. The time taken by linear algorithm rises proportionally with rise in resources. This research work is about development of an efficient algorithm based on binary search, since binary search takes less time than linear search.

Keywords: Best-Effort, Advanced Reservation, Immediate Leases, Economy Based Lease, Deadline Sensitive Lease, Linear search, Binary search.

I. INTRODUCTION

Cloud services are classified into three categories, on the basis of computing resources present in computer science ; they are infrastructure as a service which provides computing hardware resources as a service, platform as a service which provide software as a computing platform in the form of services to the customers , the computing platform provided in this service consist of tools and APIs which is used to create, configure and deploy the softwares without the complexity of buying and managing the platform resource. Software as a service which provides software applications such as email application, CRM etc to the customer as a service.

This survey is mainly about scheduling of leases and searching of resources in IaaS service

provider's data center, which uses hardware virtualization to provide computing resources to its customers. An open source virtual machine based lease management agent used here is Haizea, which enables user to send request in the form of leases. Haizea has its own lease format. Customers make use of this format and send request in terms of number of nodes, capacity of nodes, and duration of nodes[1]. Haizea takes scheduling decisions based on the coming leases and its scheduling algorithms. Haizea can take decision regarding scheduling of virtual machines but it cannot instruct the hypervisor to implement those decisions. Haizea requires an interface between it and hypervisor which can instruct hypervisor, this interface is known as virtual infrastructure manager such as Opennebula. Haizea can schedule leases in both

simulation mode and Opennebula mode[1][2][3][4]. Haizea works in three types of mode, Opennebula mode, Unattended simulation mode and Interactive simulation mode. When haizea works in Opennebula mode, it generates virtual machine management decisions, Opennebula accepts those decisions and implements them by instructing hypervisor. Haizea supports three types of leases [1]:

- Advanced Reservation Lease
- Best-Effort Lease
- Immediate Lease

II. ADVANCED RESERVATION LEASE.

A customer who wants resources for certain fixed duration in future he makes use of advanced reservation lease. In case of advanced reservation lease the request for resources may look like “Need 10 Unix servers, each with 1.2 GHz processing capability and 50 GB memory for 2 months starting from January”. Here demand for 10 nodes of Unix with certain capabilities customer is for some fixed duration in future. Advanced reservation leases have higher priority and cannot be preempted in between of execution of lease[1].

III. BEST-EFFORT LEASE

When a customer request resources in the form of a Best-Effort lease, it means that, he needs resources as soon as they are available to service provider, but if the resources are not available currently, he is willing to wait until the resources are available. Best-Effort leases are of two types preemptible best-effort lease and non-preemptible best-effort lease.

When an advanced reservation lease arrives, which has higher priority than a best-effort lease, haizea first checks whether that lease can be fulfilled in future, if not that lease will be directly rejected and if yes then haizea checks whether it need to preempt any lease in order to schedule that advanced reservation lease. If haizea need to preempt certain lease to schedule advanced reservation lease, then haizea do that by stopping less priority best-effort lease and put it back in the queue and resume that best-effort lease again, after the completion of advanced reservation lease. Preemptible best-effort leases are used for performing batch jobs, which are non-interactive in nature The only downside of this lease is that they can preempted by higher priority leases like advanced reservation and immediate leases[1].

On the other hand if customer request resources through non-preemptible best-effort lease, by that he means, he can wait for the requested resources to become available but he don't want them to be preempted in between of the lease execution by any high priority lease.

IV. BEST-EFFORT WITH DEADLINES

The advanced reservation leases are of higher priority than best-effort leases. Therefore when advanced reservation lease arrives preemptible best-effort lease get preempt. If advanced reservation leases keeps on coming best-effort leases will get starved for long period of time. The solution to this problem is that a deadline is set for every preemptible best-effort lease, which means that the best-effort lease needs to be executed before the set deadline. This indirectly set a limitation on number of advanced reservation leases that can preempt a best-effort lease during the latter's execution time [7].

V. IMMEDIATE LEASE

Customer who need resources now, immediately, and don't want to reserve them in future, the customer can do this by sending request in the form of Immediate Lease. If service provider may not be able to provide required resources immediately, the customer will change his requirement, according to what service provider is offering, but he will not ask to reserve the resources for future. If service provider cannot provide any requirement coming from customer side, the Lease will finally be dropped[5].

VI. ECONOMY BASED LEASES

In all the previously defined lease formats there is a major drawback. In any of the three leases shown above customers have no provision to tell anything about his/her budget customer may have to pay more than his budget since service provider has no way to know how much a customer is willing to invest. It may be possible that customer will be allocated with the resources having much higher price whereas low price resources would be available. Also he/she don't have any opportunity to bargain for resources, a customer can ask for resources only once in a lease. If demanded resources are not available customer don't have any other chance to ask for optional resources in the same lease. Because of this reason service provider will loose customer if he is not able to fulfill demand as per lease. Moreover a customer can never know the current

market prices of the resources service provider is having, since the database of service provider doesn't have any provision to show the market prices. The problem is for both sides, customer and service provider, both of them suffers considerable lose[6].

```
<lease-request arrival="00:00:00">
<lease preemptible="true">
<nodes>

<node-set number of nodes="1"
duration="10:00:00" budget="200">
<res type="CPU" amount="100"
weight="0.6"/>

<res type="Memory" amount="1024"
weight="0.4"/>
</node-set>

<node-set number of nodes="1"
duration="10:30:00" budget="400">
<res type="CPU" amount="100"
weight="0.8"/>
<res type="Memory" amount="1024"
weight="0.2"/>
</node-set>

</nodes>

<start>
</start>

<software>

<disk-image id="foobar.img" size="1024"/>
</software>

</lease>
</lease-request>
```

Procedure 1: Modified Lease Format[7]

This problem is solved in two modules. In module 1 lease format is changed. In module 2 an algorithm for filtering one node option out of two given in lease and searching resources in database on basis of customer's budget and resources cost is created. For simulation purpose lease is shown as an XML file called Lease Workload Format (LWF). In order to include the facility to show budget of the customer, the lease format is changed. As shown in procedure1 two new tags are added along with the other tags showing the capacity of the resources. One of the

newly added tags will contain the budget which a customer is willing to invest. This tag is named as budget tag. The other tag is named as weight tag. This tag is used to show the demanded importance or desired weight of the resource. In order to negotiate over capacity and budget with service provider lease format is changed to have two choices of demanded nodes rather than one. If service provider is unwilling to fulfill first choice, customer can ask for second choice or service provider will have an option to fulfill second choice in case he can not fulfill first choice. As shown in procedure2, the database of the service provider is also changed, here again a new tag is added, called as cost. This tag contains current market price of the resources. As a result prices of the resources will now be visible to customer. Haizea will accept leases in changed format, take out all parameters including budget and weight, and start searching for appropriate or feasible nodes available. It may possible that one or more nodes will satisfy the requirement. That means more number of alternative solutions may be possible. In order to find most optimal node out those nodes, multi criteria decision making method is used and here comes the role of weight tag. Weight is the desired importance of the requested node. A matrix is made with alternatives as rows and weight as columns and the node showing minimum deviation from positive ideal solution and maximum deviation from negative ideal solution will be selected as most optimal solution[9]. The database of service provider is shown

```
<site>
<resource-types names="CPU Memory"/>
<nodes>
<node-set number of nodes="4">
<res type="CPU" amount="100"
cost="100"/>
<res type="Memory" amount="1024"
cost="100"/>
</node-set>
<node-set number of nodes="4">
<res type="CPU" amount="100"
cost="100"/>
<res type="Memory" amount="1024"
cost="100"/>
</node-set>
<node-set number of nodes="4">
<res type="CPU" amount="100"
cost="100"/>
<res type="Memory" amount="1024"
cost="100"/>
```



```

cost="100"/>
</node-set>
<node-set number ofnodes="4">
<res type="CPU" amount="100"
cost="100"/>
<res type="Memory" amount="1024"
cost="100"/>
</node-set>
</nodes>
</site>

```

Procedure2: Sample Modified database of service provider[7]

Suppose service provider shortlist m alternatives which satisfies the capacity required by customer and budget of customer than the next job of service provider is to find the most optimal alternative out of those m . The method used here is TOPSIS

Multi Criteria Decision Making

First of all an evaluation matrix is created with m alternatives and n criteria, here criteria is weight given with each resource type, therefore we have a matrix $(x_{ij})_{m \times n}$. The matrix $(x_{ij})_{m \times n}$ is then normalized to a named,

$$R = (r_{ij})_{m \times n}.$$

Then weighted normalized decision matrix is calculated say

$$T = (t_{ij})_{m \times n} = (w_j r_{ij})_{m \times n}, i = 1, 2, \dots, m, j = 1, 2, \dots, n.$$

Then the most optimal solution is determined as:

$$So = \max \{t_{ij}\}$$

VII. LIMITATIONS IN CURRENT ALGORITHMS

The algorithm which haizea make use of to search resources in its sample database is linear. The time complexity of linear algorithm to search a list of n elements is n . Since IaaS service provider at global level have extremely large number of resource in their datacenter. The time taken by linear algorithm rises proportionally. At present service provider have to set the current market prices of the resources manually[9].

VIII. PROPOSED SOLUTION

Our research work is to design an algorithm which will make use of binary search instead of linear search since the time complexity of binary search algorithm to search an array of size n is $\log n$ the searching time based considerably low even though the number of resources in the

database is too high.

For this we add a parameter named "demand" with each resources in the database this demand parameter states the current market demand of that particular type of resources. The resources in the database are arranged in the decreasing order of their demand in the market, when leases arrives to haizea, haizea attaches a value with the demanded resources according to their market demand and make use of that value to search in its database in binary fashion.

REFERENCES

- [1] Borja Sotomayor, 1.0 Beta 2, http://haizea.cs.uchicago.edu/haizea_manual.pdf.
- [2] Mehta H.K., Gupta Eshan, "Economy Based Resource Allocation In IaaS Cloud", *International Journal of Cloud Applications and Computing*, Volume 3, Issue 2, pp. 1-11, 2013.
- [3] B. Sotomayor, K. Keahey, and I. Foster, "Combining Batch Execution and Leasing using Virtual Machines," *Proc. 17th Int'l Symp. High Performance Distributed Computing (HPDC 08)*, ACM Press, 2008, pp. 87-96.
- [4] Llorente IM, Rubén S. Montero, and Ian Foster, "Virtual Infrastructure Management in Private and Hybrid Cloud", *Internet Computing, IEEE*, pp: 14-22, *Volule 13, Issue 5, 2009*.
- [5] Eymann, T., Reinicke, M., Streitberger, W., Rana, O., Joita, L., Neumann, D., & Zini ts. Multiagent and Grid Systems, "leasing in cloud systems using the opennebula engine" *In Proceedings of the Workshop on Cloud Computing and its Application*, pp. 297-307.
- [6] Abramson, D., Buyya, R., & Giddy, J.. "A computational economy for grid computing and its implementation" *in the Nimrod-G resource broker. Future Generation Computer Systems*, 18(8), 061- 1074. doi:10.1016/S0167-739X(02)00085-7. (2002).
- [7] Nathani, A., Chaudhary, S., & Somani, G. "Policy based resource allocation in IaaS cloud", *Future Generation Computer Systems*, 28(1), 94-103. doi:10.1016/j.future .2011.05.016 (2012)
- [8] Ardaiz, O., Artigas, P., Eymann, T., Freitag, F., Navarro, L., & Reinicke, M.. "The

- catallaxy approach for decentralized economy-based allocation in grid resource and service markets”, *Applied Intelligence*, 25(2), 131–145. doi:10.1007/s10489-006-9650-9. (2006).
- [9] Buyya, R., Yeo, C. S., Venugopal, S., Broberg, J., & Brandic, I. (2009). Cloud computing and emerging IT platforms:
- [10] Akhiani, J., Chuadhary, S., & Somani, G. “Negotiation for resource allocation in IaaS cloud”, *In Proceedings of the Fourth Annual ACM Bangalore Conference* (p. 15). (2011, March).
- [11] Sotomayor, B. (2007). “A resource management model for vm-based virtual workspaces”. *Masters Thesis, University of Chicago*.
- [12] Vision, hype, and reality for delivering computing as the 5th utility. *Future Generation Computer Systems*, pp 25(6), 599–616. doi:10.1016/j.future.2008.12.001.
- [13] Sotomayor, B., Keahey, K., Foster, I., & Freeman, T. . “Enabling cost-effective resource leases with virtual machines”. *In Proceedings of the Hot Topics Session in ACM/IEEE International Symposium on High Performance Distributed Computing*. (2007).
- [14] Sotomayor, B., Montero, R. S., Llorente, I. M., & Foster, I. . “Capacity leasing in cloud systems using the opennebula engine”. *In Proceedings of the Workshop on Cloud Computing and its Application*. (2008).

REVIEW OF SUPERCRITICAL FLUID WITH DESUPERHEATER ON RANKINE CYCLE FOR THERMAL POWER PLANTS

Mayur Sen

Dept. of Mechanical Engg., MPCT, Gwalior (M.P)

Email: mayursen1994@gmail.com

Abstract

This paper presents a review of Supercritical Fluid for Rankine Cycle which operates on Thermal Power Plants as well as authentic and studies the influence of Supercritical Fluid properties on cycle performance. This paper propose that the overall thermal efficiency of a Thermal Power Plant can be enhanced by using Supercritical Fluid with Desuperheater in Rankine Cycle which alleviates turbine and pump losses that occurs due to irreversibilities. The Rankine Cycle requires provoke and attention to work on thermal power plants with Desuperheater. Many of the practical embattlements associated with Carnot Vapour Cycle are eliminated in Rankine Cycle. The steam coming out of the boiler is usually in superheated state and expands in the turbine. After expanding in the turbine, the steam is condensed completely in the condenser in Rankine Cycle. But after many methods are adopted and aggrandizement done to increase Rankine Cycle performance it abolish almost all the ordeals suffer during its operation. The motivation of supercritical fluid in Rankine Cycle is to amend the cycle performance up to 49% which is not offer or not done by the methods adopted and development of Rankine Cycle, resilient all the practical difficulties occur and come through methods and aggrandizement previously adopted in Rankine Cycle. Desuperheater is benevolent to reduce the temperature of superheated steam procure from expansion of supercritical steam to superheated steam and restored it into the saturated steam which will help the working fluid (steam) to perform effectively in cycle for cycle progress. Therefore the efficacy of Rankine Cycle will be proved by research work if exist in future with invention to make new version of Rankine Cycle which mitigate or almost eliminate all the vulnerabilities of cycle.

Index Terms: Desuperheater, Supercritical Fluid, Rankine Cycle, Thermal Power Plant.

1. INTRODUCTION

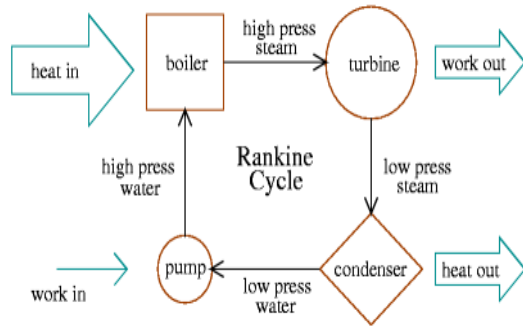
A Rankine Cycle works on Thermal power plants using water as a working fluid undergoes a change of phase. Heat is transferred to water in the boiler from an external source (furnace, where fuel is continuously burnt) to raise steam. The high pressure, high temperature steam leaving the turbine condenses into water in the condenser (where cooling Water circulate heat), and then the water is pumped back to the boiler. A Rankine Cycle was devised and accepted as the standard for steam power plants to generate a

major fraction of electric power from plant produced in the world. However maximum portion of steam is lost in form of thermal energy due to irreversibilities and losses in Rankine Cycle. The research work introduces the use of expanded steam deployedly in Thermal power plant by using Supercritical Fluid. The review focus on Analysis of Supercritical fluid with Desuperheater on Rankine Cycle for thermal power plants to find the beat solution of steam procure from operated supercritical fluid from boiler and expands into the turbine which on evoke gives the amiable and aesthetic up

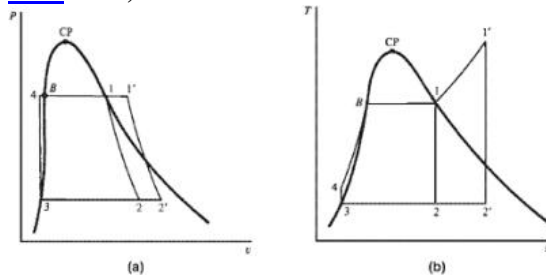
gradation of Rankine Cycle with minimum liabilities and maximum efficiency of 49% that will exist in future research work, rather than emphasized working on progressive methods of Rankine Cycle for its better performance further.

1.1 DESCRIPTION OF RANKINE CYCLE

The description can be easily comprehended by seen in the block diagram of Rankine Cycle with its PV and TS chart.



“Fig1.1” (a) Block Diagram of Rankine Cycle (STC-System-back www.theloveplan.org/stc/stc.stem back).

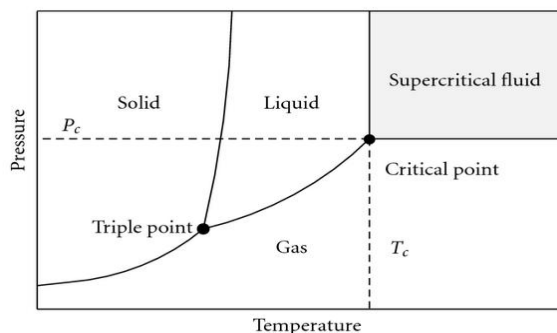


“Fig1.1” (b) PV and TS diagram of Rankine Cycle (Steam Power plants By – Philip Kiameh).

In above PV and TS diagrams the critical point is stated which shows that at this point the latent heat of steam is zero.

2.1 REVIEW OF SUPERCRITICAL FLUID

A SCF is defined as a substance above its critical temperature (T_c) and critical pressure (P_c). The critical point represents the highest temperature and pressure at which the substance can exist as a vapor and liquid in equilibrium.



“Fig2.1” PT curve of Supercritical Fluid

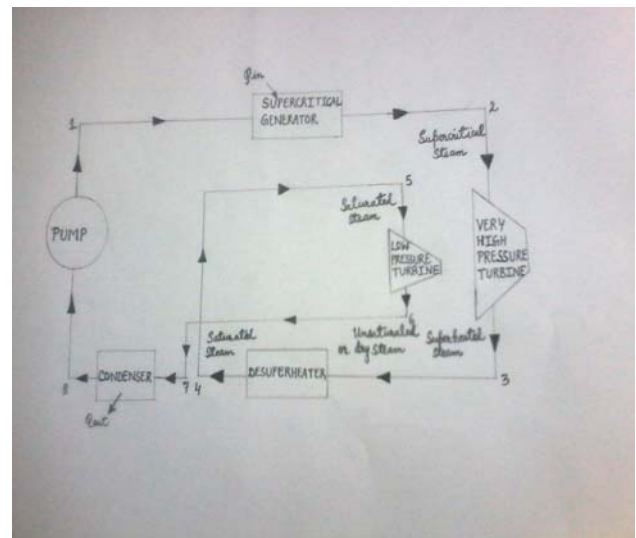
(www.hindawi.com journals of nonmaterials Supercritical CO2 foaming).

3. DESCRIPTION OF DESUPERHEATER

Desuperheater is a critical component used in the management of steam for power generation. Desuperheating is the process by which superheated steam is restored to its saturated state, or the superheat temperature is reduced. Most Desuperheater used to restore the saturated state produce discharge temperatures approaching saturation. When steam is used for mechanical power, such as driving the turbine rotor by expanding across turbine blades; it is most efficient when superheated. When steam is used for heating or other heat transfer or industrial process purposes, it is most efficient when saturated. A Desuperheater then, is a device that lowers the temperature of superheated steam and restores it to saturated steam so that it can be used effectively for industrial uses. Therefore Desuperheater is a device that injects a predetermined amount of water into a steam to reduce its temperature up to the requisite temperature.

4. CYCLE REVIEW

It is based on working operation of cycle in which Supercritical Fluid is introduced as a working fluid to work on cycle progressively. The review can be seen aesthetically in Calculations of Cycle in which all the components work efficiently to give best evoke of Cycle performance that Cycle claims in review as a result.



“Fig 4” Supercritical Fluid Rankine Cycle with Desuperheater.

Working operation:-

1. Boiler (Supercritical generator) to Very high pressure turbine.
2. Very high pressure turbine to Desuperheater.
3. Desuperheater to Low pressure turbine
4. Low pressure turbine to Condenser
5. Condenser to Pump.
6. Pump to Boiler (Supercritical generator).

4.1 CALCULATIONS OF CYCLE

In Supercritical Generator

Heat supplied to Supercritical Boiler = $h_2 - h_1$

In Condenser

Heat rejected from condenser = $h_8 - h_7$

In Very High Pressure Turbine

Work Done = $h_3 - h_2$ (1)

In Low Pressure Turbine

Work Done = $h_6 - h_5$ (2)

In Pump

Work Done = $h_1 - h_8$ (3)

Desuperheater performance

Enthalpy into process = Enthalpy out of process

$$\begin{aligned} \dot{m}_{cw} h_{cw} + \dot{m}_s h_s &= \dot{m}_d h_d + \dot{m}_{cw} h_d \\ \dot{m}_s h_s - \dot{m}_s h_d &= \dot{m}_{cw} h_d - \dot{m}_{cw} h_{cw} \\ \dot{m}_s (h_s - h_d) &= \dot{m}_{cw} (h_d - h_{cw}) \\ \dot{m}_{cw} &= \frac{\dot{m}_s (h_s - h_d)}{(h_d - h_{cw})} \end{aligned}$$

Where:

m_{cw} = Mass flow rate of cooling water (kg / h)

\dot{m}_s = Mass flow rate of superheated steam (kg / h)

h_s = Enthalpy at superheat condition (kJ / kg)

h_d = Enthalpy at desuperheated condition (kJ / kg)

h_{cw} = Enthalpy of cooling water at inlet connection (kJ / kg)

Effective Work Done = Work Done by Turbines (Very High Pressure Turbine + Low Pressure Turbine) - Work Done by Pump
 $= [(h_3 - h_2) + (h_6 - h_5)] - (h_1 - h_8)$

Thermal Efficiency = Effective Work Done / Heat Supplied = $[(h_3 - h_2) + (h_6 - h_5)] - (h_1 - h_8) / h_2 - h_1$

5. RESULT OF CYCLE REVIEW

It demystify the efficiency of Rankine Cycle can be progressed by using supercritical fluid with Desuperheater which explicates that supercritical steam of supercritical fluid can directly flash into superheated steam after expansion. The superheated steam is effectively used in Desuperheater which reduces its temperature up to the temperature of saturation steam before entering to condenser. Therefore from above calculations of cycle review it can be proved in future research work that the efficiency of Rankine Cycle using Supercritical Fluid with Desuperheater will increased up to 49% which is beat and optimistic for thermal power plants to work effectively with liberation of minimum emissions.

6. CONCLUSION

The research work if exist or done in future will augmented the thermal efficiency of Rankine Cycle by mitigating all the losses and clogs occurs previously from the amending methods of Rankine Cycle. It can only be possible if Supercritical Fluid is used in Rankine Cycle with Desuperheater for Thermal power plants cumulate the efficiency up to 49% and mollifying emissions at a greater extent as analogous to the emissions of prerequisite methods of Rankine Cycle. Hence it may widely find its applications unabortively in fields like-

1. Thermoelectric Power Generation.
2. Thermoelectric Refrigeration System.

REFERENCES

- [1] Yunus A. Cengel, and Michael A. Boles, "Thermodynamics: An Engineering Approach Seventh Edition in SI Units," IEEE Trans. Rankine Cycle: The Ideal Cycle for Vapor Power Cycles, vol. ED-7 pp. 553, April. 2011.
- [2] P.K. Nag, "Basic and Applied Thermodynamics," IEEE Trans. Simple

- Steam Power Cycle, vol. ED-2, pp. 328-329, August 2009.
- [3] M.M. El Wakil, "Power plant Technology," IEEE Trans. The Rankine Cycle Introduction, vol.ED-1, pp. 30, April.2010.
- [4] www.theloveplan.org/stc/stc.systemback, "STC-System-back," IEEE Trans. The Rankine Cycle Heat Engine, for Images.
- [5] Philip Kiameh, "Power Generation Handbook: Selection, Applications, Operation and Maintenance for images," IEEE Trans. Image Process, vol. ED-2, chapter.2: Steam Power plants. The Rankine Cycle, no.2.1, pp.15-16, Dec 2011.
- [6] www.hindawi.com, "journals on nanomaterials Supercritical CO2 foaming: Preparation of Porous Biodegradable Polymer and Its Nanocomposites by Supercritical CO2 Foaming for Tissue Engineering," IEEE Trans Image Process, Volume 2012 (2012), Article ID 836394 12 pages, 2.Supercritical CO2 foaming, no.1.
- [7] www2.spiraxsarco.com/Desuperheating, "Desuperheating: International site for spiraxsarco," IEEE Trans. Desuperheating calculations.

MANAGEMENT OF ENERGY & WASTE AND SUSTAINABLE ENVIRONMENT IN SHOPPING MALLS – AN EMPIRICAL STUDY

Abhishek Jain¹, Prabhu Dayal Arya², Ashutosh Bansal³

¹Asst. Professor, Amity University, Jaipur, Rajasthan

^{2,3}Asst. Professor, IPS-CTM, Gwalior (M.P)

Email: ajain@jpr.amity.edu¹, pd_arya@yahoo.com², bansal.ashutosh22@gmail.com³

Abstract

The research identifies examples of best practice and provides practical recommendations for developers, landlords and occupiers regarding the sustainable design and management of shopping centers. The research involved a literature review and survey of DD Mall Gwalior, DB Mall Bhopal, TI Mall Indore and other shopping centers of varying size, age, design and location, and interviews with each center's manager to elect an understanding of managers' awareness of and approach to sustainability in shopping centers, research involved interviews to determine investors, developers, architects and cost consultants approaches to sustainability in existing and new shopping centers. In this paper, we have also discussed about energy management, waste management and use of solar panels in a commercial building like DD Mall.

Keywords : Mall, Sustainability, Energy, Waste, Shopping Centre.

1. Introduction

Around 18% of Indian CO₂ emissions are accounted for by non-domestic buildings. 21% of this is comprised by the retail, sport and leisure sector, excluding caused by travel to and from shopping centres and the storage and distribution of goods. The climate change bill states that CO₂ levels should be cut by 60% by 2050. Reducing the energy consumption of buildings is a critical policy objective. Building and energy certification regulations are supported by various planning policies developed and enforced by Government of India, Ministry of New & Renewable Energy (MNRE). In addition, the rising costs of landfill and mandatory SITE WASTE MANAGEMENT PLANS will promote more recycling in commercial developments. The research included the detailed survey of 16 INDIAN shopping center's placed on GWALIOR city and interviews with their managers, as well as investors, developers, architects and cost consultant, covering both existing and new centers. Overall, shopping center's tended to

score poorly in energy efficiency, climate control, water management and building management, but better in accessibility and waste management. Shopping Centre managers are tackling sustainable policy initiatives in several ways, namely through:

- **Lighting and energy use:-** Such as having contracts with green energy suppliers, roof resurfacing for improved insulation ,auto sensitive lighting, restricting opening hours of service yards and replacing refrigeration, many of which can be achieved when refurbishing.
- **Water consumption:-** Centre's generally scored poorly here; rainwater harvesting and water recycling system were not present in any centres, but water metering and water conservation system were almost universal.
- **Waste Management :-** Some centers have sophisticated on-site system for separating and recycling materials and 1 centers were rated highly for this. This is an area of sustainability that is taken seriously.

➤ **Accessibility and Travel patterns-Park and ride polices:-** Car park charging for customers and car sharing schemes for staff is common. Several centers' also provides cycle racks, although few hand showers or other facilities for staff.

Many retailers do not rate sustainability issues very high; at the local level there are often less knowledge and enthusiasm than at head office. Larger tenants are interested, but many smaller retailers are not, being either less informed or pre-occupied with ensuring the survival of their business. This is worrying, as how retailers use the shops, they occupy is important. **Many large retail developers** take sustainability issues very

seriously, aiming for Very Good or Excellent Energy ratings. Marked differences between recent schemes and earlier ones exist, with key new features including. **Being mixed use of to maximize the** site and renewable energy use and maximize travel. Often planned as open schemes to blend with existing town centres, they are generally cheaper to build, maintain and run, as lighting, heating and cooling in public areas is much reduced or eliminated. The use of green roofs to lessen water run-off and to increase bio-diversity. Water run-off from roofs can be used for lavatories and to top up water tanks for sprinklers. Fig. 1 show the entrance gate of DD mall.



Fig. 1: Entrance Gate of DD Mall

2. Literature Review

2.1 Sustainability in Retail Sector

Property is responsible for nearly half of the total carbon emission in India, 28 % are from domestic buildings and another 18 % are from non-domestic buildings, with transport and industrial processes comprising the remainder. The chart below shows the breakdown of non – domestic CO₂ derived from MNREs founding in 2001, with the retail, sport, leisure sector accounting for around 22 % of the Indians non – domestic buildings CO₂ emissions, the majority consisting of retail alone. In addition, if you think not only about how many journeys take place to and from shopping areas by both consumers and staff, but the actual supply chain, then indirectly, retail must account for a considerable proportion of the emissions from the transport sector. Given the INDIAN government's challenging targets published in the March 2007 draft climate change bill, including a 60 % reduction in CO₂ emission by 2050 (which may move to 80 % in the near future), reducing the energy consumption attributable to building, and in

particular the retail sector, is a key policy objectives which will be fundamental in forthcoming years. This research examined the following sub issues;

- Access
- Energy
- Amenity
- Transport
- Viability
- Water
- Materials
- Waste
- Air quantity
- Design and quantity

The increasing prevalence of Corporate Social Responsibility (CSR) statements highlights the sustainability awareness of many occupiers and developers [1]. These statements generally indicate how internal operations and their business activities are shaped by sustainability principles. Internally, most describe how they strive to incorporate environmental management into their activities. Leading organizations

include reliance fresh, land securities and propping, all of whom incorporate sustainability into their property holdings and investments .

2.2 Shopping Centre Survey

Between October 2010 and February 2011 a detailed survey of Indian shopping centers ,varying in size, age, form and location ,followed by interviews with the shopping Centre managers were carried out. The survey involved assessing the baseline sustainability profile of a property and then rating it against others. The criteria were assessed:

- Operational energy efficiency
- Water management, including efficiency and re-cycling measures.
- Climate control (if any) including both type and age.
- Waste management, including storage, separation and on-site recycling facilities.
- Accessibility , by mode of transport, as this impacts on likely future economic performance.
- The presence or otherwise of an effective building management system.



Fig.2: Inside view of a mall

The interviews gave managers the opportunity to elaborate on different aspects of the survey and to highlight sustainability features within centers, as well as changes and improvements that are being made and any issues that may be coming through as landlord concerns. Questions posed focused mainly on environmental issues, although most managers were encouraged to elaborate on other operational issues, for example, customer shopping patterns or ease of pedestrian movement around the Centre. Secondary research focused on a report which covers potential improvements in energy and water consumption and management of construction waste.

2.3 Operational Energy Efficiency

Research shows that up to 22 % of Indian energy use could be saved by simple, cost effective energy efficiency. Few center's surveyed scores highly in respect, with many of the schemes scoring poorly. Perhaps not surprisingly, smaller and older schemes tended to have lower scores, although this was not always the case, since 2000, the upstream sustainability charter stated that 91% of participating shops Centre owners

said that there is room for energy efficiency improvement, although 63% of participants have reduced their CO₂ emission, collectively by 6.8 %. One 1970s Centre in the south of India has a commitment of a 7.5 % reduction in energy cost year-on-year energy target in the future and is planning to add three wind turbines to reach this. HVAC (heating, ventilation, and air conditioning) refers to technology of indoor and automotive environmental comfort. HVAC system design is a major sub discipline of mechanical engineering, based on the principles of thermodynamics, fluid mechanics, and heat transfer [2]. HVAC is important in the design of medium to large industrial and office buildings such as skyscrapers and in marine environments such as aquariums, where safe and healthy building conditions are regulated with respect to temperature and humidity, using fresh air from outdoors.

2.4 Water Management

The critical nature of water is recognized in green building programs throughout the world. Water efficiency is one of the five main categories for Indian Green Building Council's LEED certification. LEED credits related to

water use include zeriscaped landscaping, water use reduction and innovative wastewater techniques. A major thrust of water efficiency is the reduction or elimination of the use of potable water. Techniques such as rainwater capture, advanced wastewater treatment, grey water “harvesting”, and water-conserving plumbing fixtures are all tools that can be used to reduce the use of potable water. From a smart building perspective, however, the interest is in how we manage and monitor the water use in buildings. Monitoring and managing water use are really a part of the larger effort of the measurement and verification of a building’s performance [3]. Management of a building’s water use can no longer be receiving a water bill at the end of the month from the water utility and comparing the bill to the previous month’s bill. It is a water management system that monitors and manages water usage that will change the process of simply supplying water to managing the demand for water. Water use in commercial buildings obviously varies by building type, the type of plumbing fixtures, restrooms, landscaping needs, the use of hydraulic cooling systems, kitchens, cafeterias, etc. The baseline water use is calculated using building occupancy, a reduction of fixtures and fitting, and fixtures and fittings meeting or exceeding national or international plumbing codes and standards.

2.5 Waste Management

While all these people in shopping centers contribute to our nation’s economy, they also are generating a large amount of trash. Each Indian generates about 4.5 kg of trash per day, some portion of which can be found in a shopping center’s waste streams. From corrugated cardboard shipping containers to leftovers in the food court, solid waste is an issue for all retail facilities. The good news is that many shopping center managers have realized the benefits of implementing various types of waste reduction programs in their facilities. By working with supplier, hauling contractors, maintenance staff, and customers, shopping centers and other retail outlets have managed to cut costs through waste prevention and recycling, while demonstrating their environmental stewardship to the community [4]. Beyond recycling, retailers have also cut costs through waste prevention by identifying and eliminating items such as excess packaging

at their source, before they become waste. Reusing items such as shipping pallets or hangers also has great potential. And for shopping centers that decide to involve the public in their reuse and recycling efforts through public education and events, the result can be a positive image and an increase in shoppers. As more shopping centers are learning, a well-planned recycling program can produce savings: , Some shopping Centre management , saw its annual waste disposal costs drop by more than 40 percent between 2008-2010 , Real Shopping Center’s, once the largest trash producer in Bhopal, Indore, saved more than INR 67,000 from its waste disposal costs in a single year.

2.6 Accessibility

80 % OF THE SHOPPING center’s questioned performed well or better, meaning that shopping centers were generally fairly accessible by both public and private modes of transport due to their town Centre location. Some schemes provide park and ride polices ,although this is usually through the local authority rather than the shopping center’s. One shopping Centre manager also spokes of a new footwall counting system which is operating at the car parks entrance which is used to monitor the number of customers and their length to stay. Town Centre schemes have an advantage in this sector ,due to better public transport and less need for staff to travel by car. For instance, most of the staff in one town Centre schemes in the south of India walks to work or use public transport. Only 10 % of its staff use cars and there are few dedicated car spaces provided in loading bays for staff.

2.8 Building Management System

The survey sought information about modern building management system and weather tenants are provided with handbooks to help them act sustainability. The results demonstrated significant variation in practice.

Those which scored the highest contained, modern, effective system and those whose scores were especially high handed out guidebooks on efficient environment management, although not many carried out both [5].

There is some encouraging news –some centers are invested in modern building management system, and several of the samples are planning to provide guidance to their guidance to their tenants.

2.7 Retailors

Media attention on the retail sector often portrays a sector which is sustainable progressive, with some retailers forging revolutionary sustainability action plans. It is clear that, however, that attitude does not permeate through the whole sector, shopping Centre managers commented that larger tenants were taking action ,but many smaller retailers were not ,either because they were less well informed or else they were pre-occupied with ensuring the survival of their business. Indeed, our research suggests that overall, retailers do not rate sustainability issues very highly and operation cost and service charges are constantly under intense scrutiny by retailers. Our recent survey supports this view; in our winter 2007/8 corporate Real estate Survey. Retailers were less concerned with sustainability issues than occupiers generally. The key findings were-

- Quality of accommodation, property cost or business expansion rank far higher than energy savings.
- Energy efficiency and sustainability of buildings are ranked lower by retailers than occupiers generally and much lower than facts.
- Very few retailers use energy costs and the efficiency of a building as a negotiation strategy when leasing a building, unlike other sectors.
- Furthermore, far fewer retailers would be prepared to pay a green rental premium than in other sectors.

2.9 Energy

- Mixed use and Enclosure: Mixed use schemes maximize the use of the site and use of

renewable energy and minimize the need for travel, new centers are now often open schemes, as in Jaipur One, or covered rather than enclosed [6]. Open schemes blend in better with the existing fabric of town centres, finding favor with local planning authorities. They tend to more sustainable and cheaper to run, as lightning ,heating and cooling in public areas in either much reduced or eliminated.

- Heating And Cooling: in enclosed centers , natural ventilation for cooling and using the heat from shop units to heat mall areas is now commonplace. Balancing the amount of glazing to maximize daylight levels, but also to avoid unnecessary solar gain and air conditioning is important.
- Renewables: Incorporating renewable technologies is more effective in large mixed schemes, especially centralized CHP plants, as different uses of buildings are complementary in terms of energy requirements at different times of day. The proposed schemes of Bhopal City and TI Mall in Indore are good examples. Developers must ensure that retailers do not duplicate heating and cooling facilities.
- Efficiency: It is more cost-effective to reduce energy consumption rather than rely on renewables. Furthermore local authorities may accept a reduced energy demand in lieu of the use of onsite renewable energy.
- Service Yards :The servicing of shopping center's is an important issue for retailers and local authorities and hence for developers.



Solar Panel in Crystal Palm Jaipur

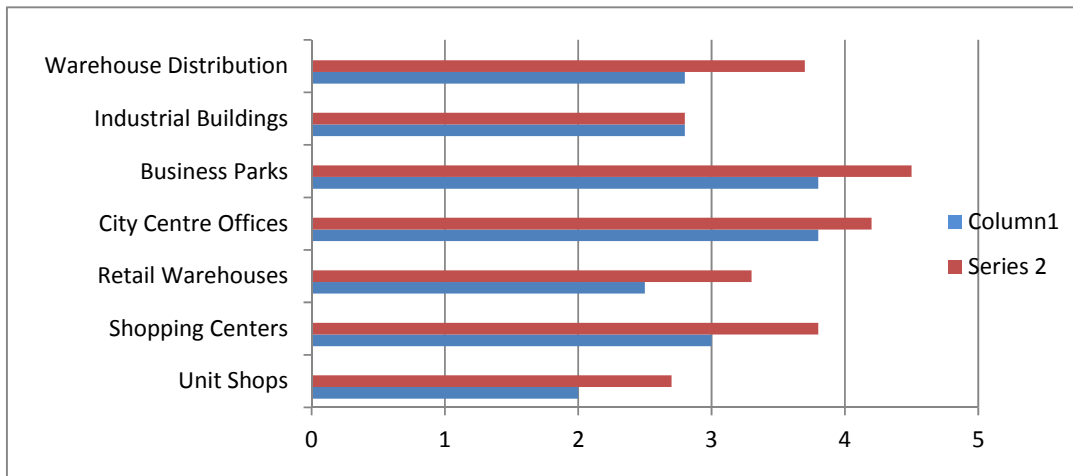
2.10 Retailers Waste

- Collection, separation, baling/compaction of waste to maximize recycling and minimize the use of landfill is now a common feature in existing and new shopping centres is reflecting the need to maximize recycling which will probably necessitate larger service areas to accommodate refuse bins and baling/compacting machinery.
- Investors interest in sustainability issues to some extent mirrors that of developers and retailers ,with larger investors leading the way and incorporating sustainability in decision making but not yet as a critical issue. Evidence for this comes from our 2008 investors survey , the key pertinent findings of which include;
- 63 % of respondents attached some importance to sustainability issues when considering new purchases, whilst 30% classed sustainability issues of equal importance with other factors. However , only 6 % rated sustainability of no importance. Traditional consideration of location , yields , rental growth and rates of return are uppermost.
- 73% of large institutional investors reported that they had assessed the majority of their properties against sustainability criteria ,or intended to within the next 12 months, compared with 45% for all investors . Larger investors gave a higher mean rating for the current sustainability off their portfolios ,than investors as a whole(mean rating of 2.4)
- In terms of property sectors in their portfolios, investors saw sustainability issues as having the largest impact on the office sector with shopping centres next in importance . This was a higher score than for retail warehouses and unit sops(as well as industrial property or warehouses) . Investors, such as Wipro Technologies, ONGC,TNPL etc , who are at the forefront of the sustainability agenda, believe that sustainability issues will become increasingly important to investors over the next few years. Whilst there is little evidence yet to stronger returns being achieved , many investors think this is inevitable , as the benefits of high levels of sustainability for shopping Centre investments can be summarized as being;
 - Better tenant retention , although at present this would largely relate to the larger retailers who are more concerned about sustainability issues.
 - Shorter void period between leases , but again this is probably more applicable to larger retailers than smaller retailers.
 - Higher rents eventually than in less sustainable centres , and stronger rental growth, as more retailers embrace the need to be sustainable.
 - Reduced rate of depreciation ,as more stringent regulations will penalize older, less sustainable centres.
 - More liquidity in the future, i.e, quicker to sell as more investors take on board sustainability issues.

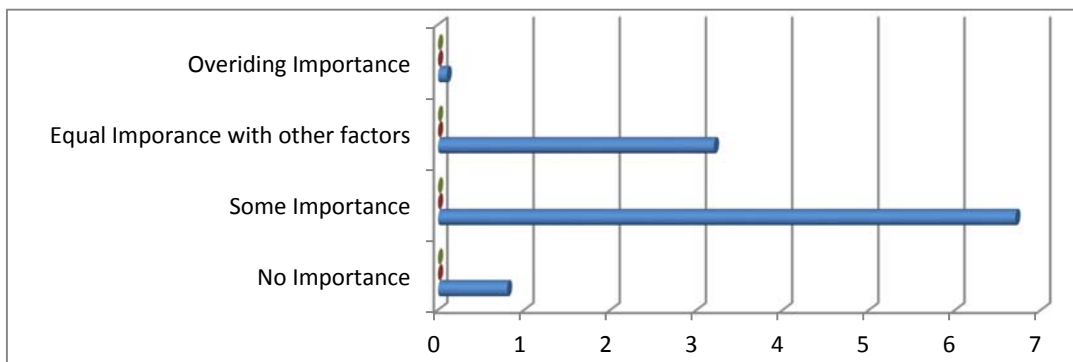


Fig. 4: Reliance Outlet in Patna

Sector-wise Impact of Sustainability



Importance of Sustainability for Investment



3. Summary of Findings

The use of illustrating that for existing shopping centers, sustainability performance varies considerably with age, location, size, weather centers are placed, covered, enclosed or open, and how they are managed. Only one Centre achieved an overall performance that was very good. Several followed just below this level of performance, whilst the majority were bunched together around an average performance level and a few performed poorly. The message coming through from the holistic scores was that age, location, size and type of Centre are less critical to sustainability measures, many of which can be factored in at refurbishment. A picture of poor performance is revealed in some areas, including;

- Energy Efficiency
- Climate Control
- Water Management
- Building Management
- Waste management
- Accessibility

Reference:

- [1] The state of Queensland (Department of Employment, Economic Development and innovation) 2010, Quick facts, Available:
- [2] Australian Standard 3598:2000 Energy Audits
- [3] Environmental Training Guide for IU Schools, Centers and Sections.
- [4] Energy Greenhouse Opportunities Act 2006 (commonwealth) and associated legislation
- [5] National Greenhouse and Energy Reporting Act 2007 (Commonwealth) and associated legislation
- [6] Environmental Training Checklist for IU Schools, Centers and Sections.

SPEED CONTROL OF THREE PHASE INDUCTION MACHINE USING MATLAB

Maheshwari Prasad¹, Himmat singh², Hariom Sharma³

¹Phd Scholar, Mahatma Gandhi Chitrakot University, Gwalior (M.P)

^{2,3}MITS, Gwalior, (M.P)

Email:mediaee.ips@gmail.com¹,ahiwar.himmat@gmail.com²,rinku.shaan21@gmail.com³

Abstract

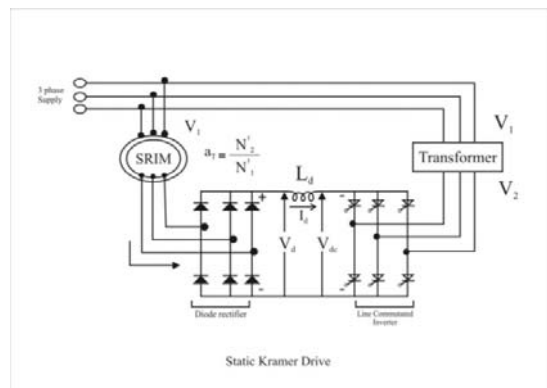
In this thesis a new slip power recovery scheme is presented of the three phase induction motor which is fed from a rectifier inverter system. Here rotor voltage is rectified, converted in to ac using inverter system and then Step up by step up Transformer. The simulation is carried out with three phase induction machine. In this method not only the starting of machine is simple but this scheme also provides flexibility in speed control and calculates the performance parameters

Steady-state performance analysis of the drive is done with the help of dc and ac mathematical models. MATLAB simulation of this drive is done using equivalent circuit model of the wound rotor induction motor. This drive is developed in the laboratory for a wound-rotor induction motor. Theoretical and experimental performances and simulation results are found as expected.

INTRODUCTION

As we know in case of three phase induction motor the portion of air gap power which is not converted into mechanical power is called as slip power. As in the most of the industrial application in induction motor has been Used in the past mainly in application requiring a constant speed because conventional method of their speed control have been expensive or highly inefficient but due to availability of thyristor,IGBT have allowed the development of variable speed induction motor drive

In this scheme shown in figure1. The rotor terminals are connected to the ac input Supply though to fully control bridges.Bridge1 operates as a rectifier and bridge2 operates as a inverter to feed the power output of the rotor back into the A.C. mains this is known as slip power recovery scheme.



1.1 Steady State Induction Machine Analysis

This section of the course considers the induction machine in steady state. The term steady state refers to the fact that the RMS currents and voltages, mechanical torque and speed, etc. are constant during the period being analysed.

Considering balance steady state operation, the machine can be analysed using a per-phase equivalent circuit. Later, when transient conditions are considered, the per phase circuit can no longer be applied.

To begin with, machines are analysed as though a variable voltage and frequency sinusoidal supply is available. Once the principles behind operation with sinusoidal supply have been considered, the power electronic circuits capable of producing variable voltage and frequency outputs are briefly described and analysed. The effects of applying the non-sinusoidal outputs of power electronic circuits to machines are analysed, together with the impact on the power system.

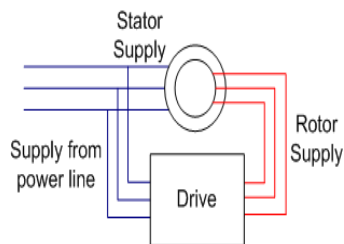
In addition to considering the impacts of changing the stator supply conditions, the option of applying control to the rotor circuit, "slip control" will also be considered.

Limits on steady state operation

It is important to remember that during steady state operation, there are two fundamental limits on operation

- The stator supply voltage should not exceed the rated, (or base), value: $V_s < V_{sb}$
- The stator current should not exceed the rated, (or base), value: $I_s < I_{sb}$

Exceeding rated voltage can cause premature insulation breakdown, resulting in motor failure. Exceeding rated currents causes excessive heating, again resulting in insulation breakdown and motor failure.



Whether the supply being controlled is to the stator or to the rotor, the drive must perform one basic function. It must convert a fixed-voltage, fixed-frequency supply to variable-voltage, variable-frequency (VVVF). This in turn may be done one of two ways:

- Direct AC-AC Conversion
- AC-DC Conversion plus DC-AC Conversion

1.2 Slip Control

Slip control is only possible with wound rotor induction motors. The principle of slip control is to control the speed of the motor by adjusting the

rotor circuit, **while the stator supply voltage and frequency remain constant.**

Consider the equivalent circuit of a wound rotor induction machine with the rotor circuit not referred to the stator.

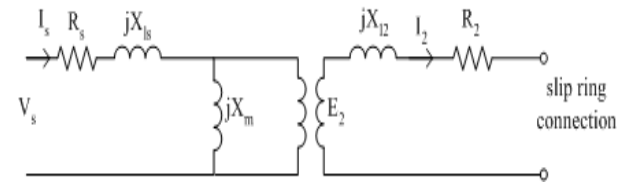


Fig-3

Note that to maintain the drives notation of subscript "r" to denote rotor variables referred to the stator, subscript "2" is used for actual rotor circuit parameters. This is the reverse of the standard machines notation used in the machine course.

Applying slip control, air gap power is diverted from the mechanical system to an external rotor circuit. This can be achieved with an external resistance:

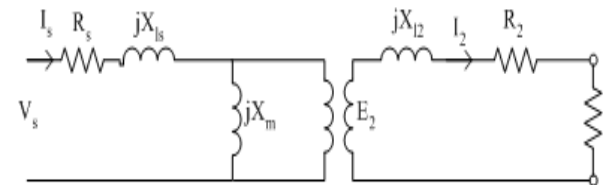


Fig-4

or by applying a voltage to the rotor slip rings

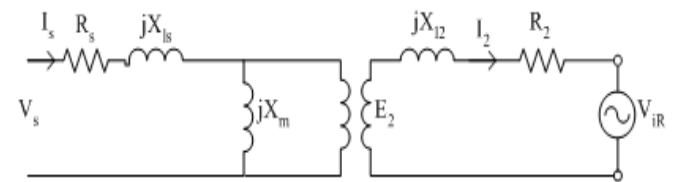


Fig-5

2.1 WORKING PRINCIPLE OF SLIP POWER RECOVERY SCHEME

The three phase controlled induction motor drive has a low efficiency, its approximate efficiency equals the PU speed. As speed decreases, the rotor copper losses increase, thus reducing the output and efficiency. The rotor copper loss are given by

$$P_c = 3 I_2'^2 R_2'$$

Where P_a is the air gap power. The increase in this slip power, result in a large rotor current. This slip power can be recovered by introducing a variable EMF sources in the rotor of the

induction motor and absorbing the slip power into it. By linking the EMF source to A.C. supply lines through a suitable power converter. The slip power energy is sent back to the A.C. supply. This is by varying the magnitude of the E.M.F source in rotor, the rotor current, torque and slip are controlled. The rotor current is controlled and hence rotor copper losses, and a significant portion of the power that would have been dissipated in the rotor is absorbed by the E.M.F source, thereby improving the efficiency of the motor drive

In slip power recovery scheme we control the speed below and above of the base speed .For sub synchronous speed control, bridge one has firing angle less than 90 degree whereas bridge two has firing angle more than 90 degree. In other words, bridge one works as rectifier and bridge two as line co mediated inverter.

While for super synchronous motor control, bridge one is made to work as line commutated inverter with firing angle more than 90degree and bridge two as a rectifier with firing angle less than 90 degree. The power flows is now from load to supply.

RESULTS

The simulation of slip power recovery scheme has been done by the use of MATLAB-SIMULINK for the purpose of simulation first of all the model file of different firing angle speed shown in figure.

1. Now let us take a look on change in speed with firing angle.

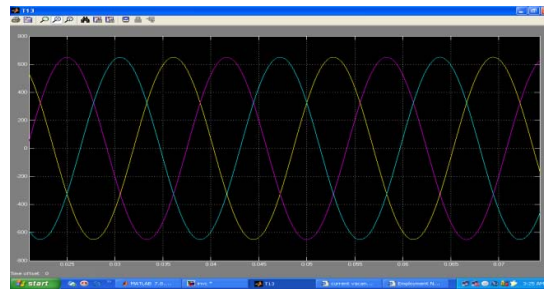
- (i) At firing angle of $\alpha=50$ deg. Speed become 1100 rpm
- (ii) At firing angle of $\alpha=40$ deg. Speed become 1300 rpm
- (iii)At firing angle of $\alpha=35$ deg. Speed become 1500 rpm
- (iv) At firing angle of $\alpha=30$ deg. Speed become 1700rpm
- (v) At firing angle of $\alpha=25$ deg. Speed become 2000 rpm

In the slip power recovery scheme highest firing angle at the lowest motor speed giving highest

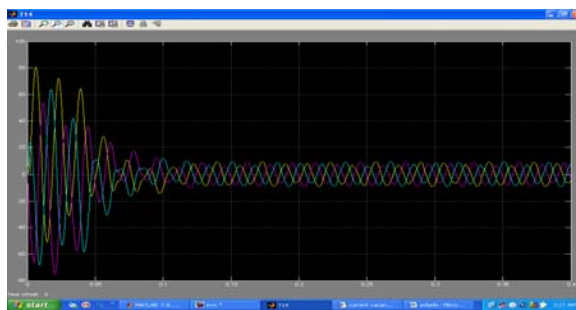
power factor and lowest reactive power at the lowest speed this improves the drive power factor and reduces reactive power at all speeds in the speed range of the drive.

It means that as an increasing the firing angle the speed decrease and vice-versa this also can be shown by a graph of speed.

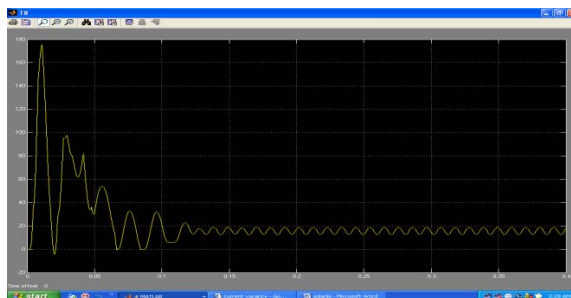
We observe various waveform at different firing angle shown in figure.



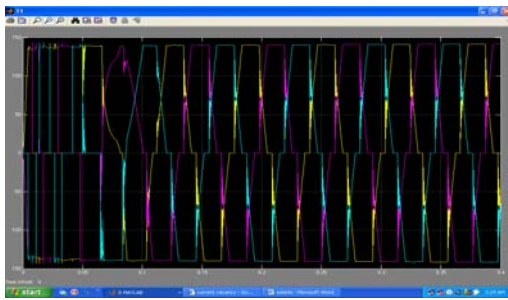
Wave form of three phase source in volt



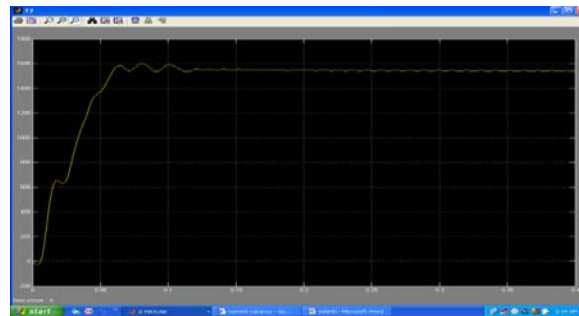
Wave form of three phase current source



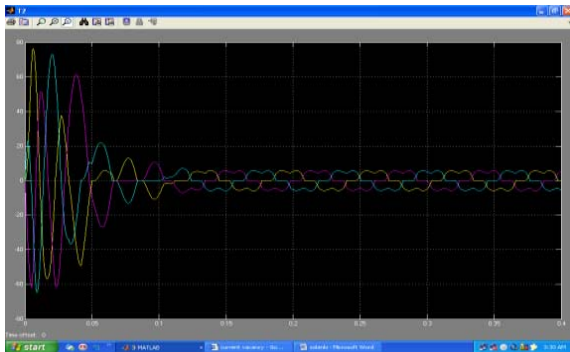
Wave form of Torque NM



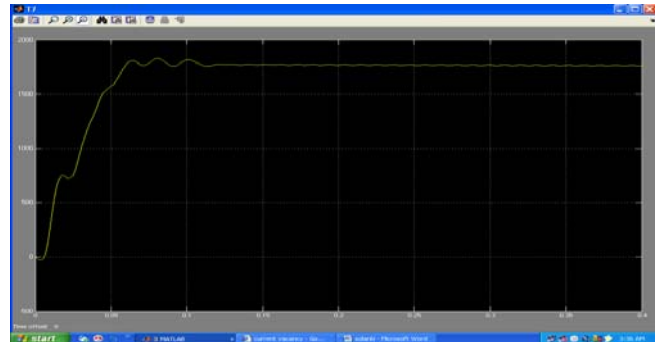
Wave form of three phase inverter out put in volt



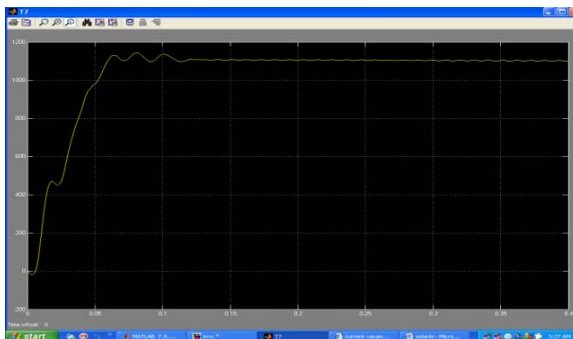
Speed wave form at firing angle =35deg



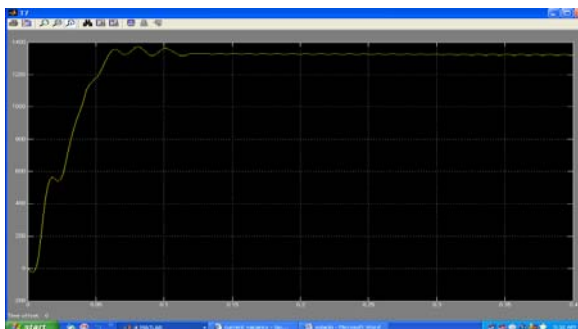
Wave form of three phase rotor current in am



Speed wave form at firing angle =30deg



Speed wave form at firing angle =50de



Speed wave form at firing angle =40deg

CONCLUSION_-The new slip power recovery scheme for speed control of three phase induction motor not only improve the power factor but also provide the flexible and simple starting of machine as explained earlier the interface transformer is replaced by step up chopper. The slip power frequency scheme is operates on 3-phase induction motor using Kramer drive .Kramer Drive simulated with 3-phase induction motor by using MATLAB application on Kramer drive we obtain the slip power recovery .

5.2 SCOPE FOR FUTURE WORK

As in the time of starting the three phase supply is connected momentarily to the stator with load duty ratio of chopper. As soon as the machine a trend some speed to produce sufficient back emf in the stator binding to commuted the inverter switches and then motor is disconnected from supply and is fed by DC link this problem can be eliminated by using IGBT and MOSFET to make a starting more simple harmonics can be further reduced by using PWM technique the speed control range should be increased.

REFERENCES

1. performance analysis and simulation of inverter fed slip Energy Recovery Drive IEEE transaction vol.85 september 2004.
2. A step down chopper controlled slip ENERGY Recovery I/M Drive IEEE transaction on energy conversion Vol.8 september 1993.
3. Modling and performance of slip Energy Recovery I/M Drive IEEE transaction vol.5 september 1990.
4. Starting transients in slip Energy Recovery Drive IEEE transaction vol.07 March 1990.
5. A New energy recovery double winding cage rotor. IEEE transaction on energy conversion Uvol.no.18 02 jun 2003
6. Numerical simulation method for the slip energy recovery system an induction machine vol.146.jan1999.
7. Calculation of slip energy induction motor drive behavior using equivalent IEEE transactions on industry using application vol no. 30 feb 1994.
8. A New Energy Recovery scheme for double fed adjustable speed motor drivers IEEE transaction on industry application vol.no. 2 April.1988. A New slip power Recovery scheme with improved supply power factor IEEE transaction on power electronics. Vol.no.2 April.1988.
9. Calculation of slip Energy Recovery induction motor drive behavior using them equivalent circuit by P.Pillay.
10. E.Akpinar and P.Pillay, "Modeling and performance of slip energy recovery induction motor drives", IEEE Trans., vol EC 5, No. 1, March 1990, pp 203-210.12.
11. 3. L.Refoufi, P.Pillay and M.R.Harris, "A chopper-controlled slip energy recovery induction motor drive", IEEE 1992 PES Summer Meeting, Seattle, Washington.
12. P.C.Sen and K.H.J.MA, "Rotor chopper control for induction motordrive" IEEE Trans., vol IA-11, .Jan/Feb 1975, pp. 43-49.
13. A.Lavi and R.J.Polge, "Induction motor speed control with static inverter in the rotor", IEEE Trans., PAS 85, Jan 1966, pp. 76-84.
14. A Lavi and R J Polge. Induction Motor Speed Control with Static Inverter in the Rotor.. IEEE Transaction on Power Apparatus and Systems, vol PAS-85, no 1, January 1966, pp 76-84.16. May 1970, pp 948- 956.
15. S K Pillai and K M Desai. A Static Sherbius Drive with Chopper.. IEEE Transaction on Industrial Electronics and Control Instrumentation, vol IECI-24, no 1, February 1977, pp 24-29.
16. S R Doradla, S Chakravorty and K E Hole. A New Slip Power Recovery Scheme with Improved Supply Power Factor.. IEEE Transaction on Power Electronics, vol 3, no 2, April 1988, pp 200-207.
17. L Refoufi, P Pillay and M R Harris. A Step-Down Chopper-Controlled Slip Energy Recovery Induction Motor Drive.. IEEE Transaction on Energy Conversion, vol 8, no 3, September 1993, pp 396-403.
18. A K Mishra and Dr A K Wahi. A New Slip-Power Recovery Scheme for nverter-Fed Induction Motor Drive.. National Conference on Electric Drives and Control for Transport Systems, January 16-18, 1997.

ANALYSIS OF ELECTRICAL LOAD FORECASTING BY USING MATLAB TOOL BOX THROUGH ARTIFICIAL NEURAL NETWORK

Neeraj Pandey¹, Sanjay Kulshrestha², Manoj Kumar Saxena³

^{1,2}Assistant Professor, Department of Electrical Engg., IPS-CTM Gwalior (M.P)

³Lecturer, Dept. of Electrical Engineering, Govt. Polytechnic College, Morena (M.P)

Email:neerajpandeyips@gmail.com¹, sk.kulshreshtha12@gmail.com²,

manojgw1@gmail.com³

Abstract

Load forecasting is a central integral process in the planning and operation of electric utilities. Load forecasting has become in recent years one of the major areas of research in electrical engineering. The main problem for the planning is the determination of load demand in the future. Because electrical energy cannot be stored appropriately, correct load forecasting is very essential for the correct investments. Effective forecasting, however, is difficult in view of the complicated effects on load by a variety of factors such as temperature, humidity. In this paper a three-layered feed forward neural network are trained by the Levenberg-Marquardt algorithm and a radial basis function using matlab programming and matlab tool-box. The Proposed neural network based model is used for forecasting next-week electricity prices. We evaluate the accuracy of the price forecasting attained with the proposed neural network approach, reporting the results from the electricity markets of India.

Keywords: price forecasting, neural networks, radial basis function, Levenberg-Marquardt Method, Matlab-Tool box

Introduction: Power load forecasting is one of the important works of power dispatching department. Improving the technical level of power load forecasting not only can accurately predict the demand of electricity market and convenient to power companies develop reasonable grid construction planning to improve the economic and social benefits of the system, but also be effective to predict the safety of power system operation and provide a reliable basis for the grid operation, maintenance and repair [1]. Various techniques of load forecasting had been reported for past decades. In summary, they can be classified as traditional methods based on mathematical models and soft-computing techniques. Hybrid of the referred methods [2-3] has also been achieving good performances. However, load forecasting is characterized with stochastic and uncertainty,

so new techniques have to possess with high-level ability to represent and tackle various uncertainties. Thus Predicting future prices involved matching regional electricity demand to regional electricity supply.

The main problem for the planning is the determination of load demand in the future. Because electrical energy cannot be stored appropriately, correct load forecasting is very essential for the correct investments. Effective forecasting, however, is difficult in view of the complicated effects on load by a variety of factors such as temperature, humidity. Many short-term load forecasting methods have been developed including regressions methods, similar day approach, exponential smoothing; iterative reweighted least-squares, adaptive load forecasting; stochastic time series, ARMAX

models based on genetic algorithms, fuzzy logic, neural networks and knowledge-based expert systems. Classical approaches are based on statistical methods. It assumes a stationary load series. The relationship between load demand and factors influencing the load demand however, is non linear therefore it is difficult to represent this complex non-linearity by conventional methods. Artificial intelligence methods have the ability to give better performance in dealing with the nonlinearity. A conventional ANN model sometimes can suffer from a sub optimization problem and over-fitting. These problems produce unsatisfactory forecasting accuracy. Selection of pre-training parameters and Network architecture significantly affects the performance and requires users to have in-depth knowledge of neural network methods.

In this paper a three-layered feed forward Neural Network is trained (1) first by the Levenberg-Marquardt algorithm (2) secondly by radial basis function. The proposed ANN structure has been prepared by using Neural Network Matlab Tool Box. We evaluate the results obtained by both the proposed approach and a comparative study has done. The inputs defined for the model are (1) maximum temperature of i^{th} day $T_{\max}(i)$, (2) minimum temperature of i^{th} day $T_{\min}(i)$, (3) average Temperature of i^{th} day $T_{\text{ave}}(i)$, (4) peak load of the i^{th} day $L_{\max}(i)$ (5) peak load of the previous day $L_{\max}(i-1)$ (6) peak load of seven days ago $L_{\max}(i-7)$ and (7) peak load of the eight days ago $L_{\max}(i-8)$.

To demonstrate the effectiveness of the proposed ANN approach, the both the ANN models have been trained and tested on actual load data and weather data for year 2014 to 2015 provided by i) Gwalior Region of Madhya Pradesh Madhya Kshetra Vidyut Vitaran Company Ltd. (MPMKVVCL) and Indian weather department, Indian Republic for peak load forecasting and ii) from Madhya Pradesh Power Transmission Company Ltd. (MPPTCL), Jabalpur for forecasting hourly load of M.P region.

The networks designed for one day ahead STFL have different numbers of input nodes, two hidden

layers and 24 output nodes. To speed up the learning process adaptive learning rate is used. In the training process day type, the weather variables and load data of the past few days are used as input variables. Once trained, the designed ANN is capable of forecasting the next day peak load for twenty four hours accurately. To ensure the good training, the network was trained using large data set for 360 days and the unseen data of 65 days were used for testing the performance of trained network. Comparative study of different ANN structures has been done for different input parameters. It was observed that the designed ANN was capable of predicting the next day peak load quite accurately and RMS testing error was limited to 2.18 %.

It was observed in the present work that the results obtained by Levenberg-Marquardt method for the same ANN structure are better than results obtained by Radial basis functions. In addition for Radial basis function spread constant had to adjust to obtain better results. When all the parameters described above are taken as input the obtained results have minimum testing error.

An accurate forecast of electricity prices has become a very important tool for producers and consumers. In the short-term, a producer needs to forecast electricity prices to derive its bidding strategy in the pool and to optimally schedule its electric energy resources. In a regulated environment, traditional generation scheduling of energy resources was based on cost minimization, satisfying the electricity demand and all operating constraints. Therefore, the key issue was how to accurately forecast electricity demand. In a deregulated environment, since generation scheduling of energy resources, such as hydro and thermal resources, is now based on profit maximization, it is an accurate price forecasting that embodies crucial information for any decision making. Consumers need short-term price forecasts for the same reasons as producers.

It should be noted that price series exhibit greater complexity than demand series, given specific characteristics existing in price series. In most competitive electricity markets the series of prices presents the following features: high frequency, non constant mean and variance, daily and weekly seasonality, calendar effect on weekend and public holidays, high volatility and high percentage of unusual prices.

Price forecasting has become in recent years an important research area in electrical engineering, and several techniques have been tried out in this task. In general, hard and soft computing techniques could be used to predict electricity prices. The hard computing techniques, where an exact model of the system is built and the solution is found using algorithms that consider the physical phenomena that govern the process, include time series models, auto regressive — AR models and auto regressive integrated moving average — ARIMA models[4,5,6]. This approach can be very accurate, but it requires a lot of information, and the computational cost is very high. More recently, generalized autoregressive conditional heteroskedastic— GARCH models and the Wavelet-ARIMA technique have also been proposed.

The soft computing techniques, namely artificial intelligence techniques, do not model the system; instead, they find an appropriate mapping between the several inputs and the electricity price, usually learned from historical data, thus being computationally more efficient. In particular, neural networks approaches, which have been widely used for load forecasting with successful performance, are now used to predict electricity prices.

Neural networks are simple, but powerful and flexible tools for forecasting, provided that there are enough data for training, an adequate selection of the input–output samples, an appropriate number of hidden units and enough computational resources

available[4,5]. Also, neural networks have the well-known advantages of being able to approximate any nonlinear function and being able to solve problems where the input–output relationship is neither well defined nor easily computable, because neural networks are data-driven. Three-layered feed forward neural networks are specially suited for forecasting, implementing nonlinearities using sigmoid functions for the hidden layer and linear functions for the output layer.

This paper proposes a neural network approach to forecast next-week prices in the electricity market of India. The Levenberg-Marquardt algorithm is used to train a three-layered feed forward neural network. Previously reported approaches to forecast prices in the electricity market of India were mainly based on time series models, namely the ARIMA technique. Neural networks approaches are comparatively easy to implement and show good performance being less time consuming.

2. Neural network approach

Neural networks are highly interconnected simple processing units designed in a way to model how the human brain performs a particular task. Each of those units, also called neurons, forms a weighted sum of its inputs, to which a constant term called bias is added. This sum is then passed through a transfer function: linear, sigmoid or hyperbolic tangent. Fig. 1 shows the internal structure of a neuron.

Multilayer perceptrons are the best known and most widely used kind of neural network. Networks with interconnections that do not form any loops are called feed forward. Recurrent or non-feed forward networks in which there are one or more loops of interconnections are used for some kinds of applications [8,9]. The units are organized in a way that defines the network architecture. In feed forward networks, units are often arranged in layers: an input layer, one or more hidden layers and an output

layer. The units in each layer may share the same inputs, but are not connected to each other. Typically, the units in the input layer serve only for transferring the input pattern to the rest of the network, without any processing.

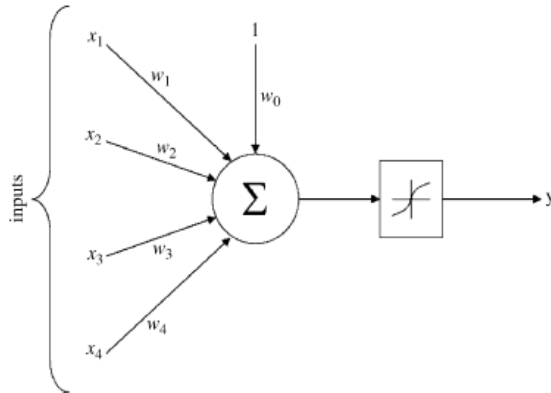


Fig. 1. Internal structure of a neuron.

The information is processed by the units in the hidden and output layers.

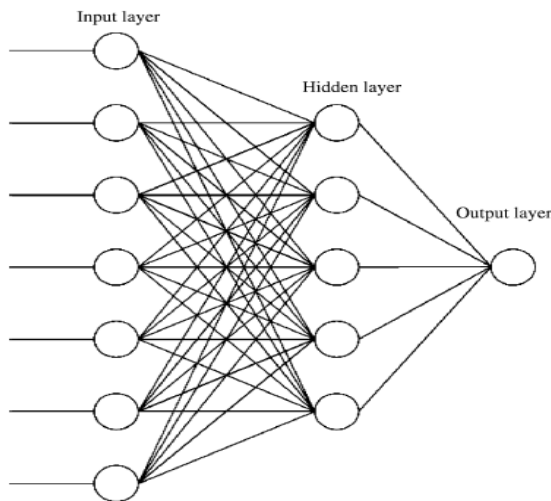


Fig. 2. Example of a three-layered feedforward neural network model with a single output unit.

Fig. 2 shows the architecture of a generic three-layered feed forward neural network model. The neural network considered is fully connected in the sense that every unit belonging to each layer is connected to every unit belonging to the adjacent layer. In order to find the optimal network architecture, several combinations were evaluated. These combinations included networks with different

number of hidden layers, different number of units in each layer and different types of transfer functions. We converged to a configuration consisting of a one hidden layer that uses a hyperbolic tangent sigmoid transfer function, defined as:

$$f(s) = \frac{1-e^{-s}}{1+e^{-s}} \quad (1)$$

Where s is the weighted input of the hidden layer, and $f(s)$ is the output of the hidden layer. The output layer has only one unit with a pure linear transfer function[10,11].

Forecasting with neural networks involves two steps: training and testing. Training of feed forward networks is normally performed in a supervised manner. One assumes that a training set is available, given by the historical data, containing both inputs and the corresponding desired outputs, which is presented to the network. The adequate selection of inputs for neural network training is highly influential to the success of training.

In the learning process a neural network constructs an input-output mapping, adjusting the weights and biases at each iteration based on the minimization of some error measure between the output produced and the desired output. Thus, learning entails an optimization process. The error minimization process is repeated until an acceptable criterion for convergence is reached [12].

The knowledge acquired by the neural network through the learning process is tested by applying new data that it has never seen before, called the testing set. The network should be able to generalize and have an accurate output for this unseen data[13]. It is undesirable to overtrain the neural network, meaning that the network would only work well on the training set, and would not generalize well to new data outside the training set [20]. Overtraining the

neural network can seriously deteriorate the forecasting results.

Also, providing the neural network with too much or wrong information can confuse the network and it can settle on weights that are unable to handle variations of larger magnitude in the input data .

$$\Delta x = - [\Delta^2 V(x)]^{-1} \Delta V(x) \quad (2)$$

where $[\Delta^2 V(x)]$ is the Hessian matrix and $\Delta V(x)$ is a gradient vector. Assuming that $V(x)$ is sum of square errors given by:

$$V(x) = \sum_{h=1}^n e_h^2(x) \quad (3)$$

$$\Delta V(x) = 2 J^T(x) e(x) \quad (4)$$

$$\Delta V^2(x) = 2 J^T(x) J(x) + 2 S(x) \quad (5)$$

where $e(x)$ is error vector and $J(x)$ is jacobian matrix given by:

$$J(x) = \begin{bmatrix} \frac{\partial e_1(x)}{\partial x_1} & \frac{\partial e_1(x)}{\partial x_2} & \dots & \frac{\partial e_1(x)}{\partial x_n} \\ \frac{\partial e_2(x)}{\partial x_1} & \frac{\partial e_2(x)}{\partial x_2} & \dots & \frac{\partial e_2(x)}{\partial x_n} \\ \vdots & \vdots & \ddots & \vdots \\ \frac{\partial e_N(x)}{\partial x_1} & \frac{\partial e_N(x)}{\partial x_2} & \dots & \frac{\partial e_N(x)}{\partial x_n} \end{bmatrix} \quad (6)$$

and where $S(x)$ is given by:

$$V(x) = \sum_{h=1}^n e_h(x) \Delta^2 e_h(x) \quad (7)$$

Neglecting the second-order derivatives of the error vector, i.e. assuming that $S(x) \approx 0$, the Hessian matrix is given by:

$$\Delta V^2(x) = 2 J^T(x) J(x) \quad (8)$$

and substituting Eqs. (8) and (4) into Eq. (2) we obtain the Gauss–Newton update, given by:

$$\Delta x = -[J^T(x) J(x)]^{-1} J^T(x) e(x) \quad (9)$$

The advantage of Gauss–Newton over the standard Newton’s method is that it does not require calculation of second-order derivatives. Nevertheless, the matrix $J^T(x) J(x)$ may not be invertible. This is overcome with the Levenberg-Marquardt algorithm, which consists in finding the update given by:

$$\Delta x = -[J^T(x) J(x) + \mu I]^{-1} J^T(x) e(x)$$

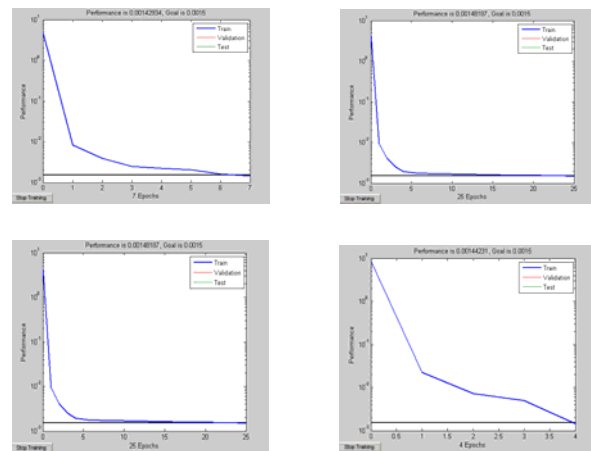
Where parameter μ is conveniently modified during the algorithm iterations.

Data selection and normalization:

Historical data from market, namely electricity prices and hours are input parameter to train the neural network in this paper. The transfer functions used for the hidden and output layers are, *tansig*, a hyperbolic tangent sigmoid transfer function with outputs between -1 and 1; *purelin*, a pure linear transfer function. Here data is normalized between 0 and 1 for training and testing purpose.

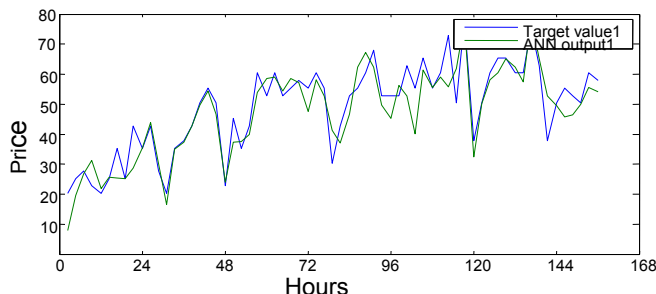
Case study: neural network approach based on Levenberg- Marquardt and radial basis function both, applied on historical data from electricity market. It was observed that the testing error in case of first method is less in comparison of second method.

Training results of different ANN Networks (6-10-24,6-15-24,6-30-24,6-40-24) with learning rate 0.05



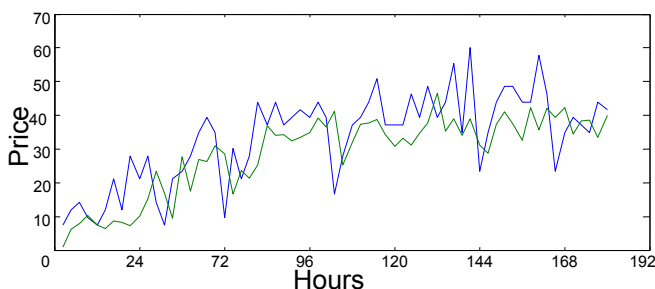
Result from Levenberg_Marquardt Method:

Training error(RMS value)	Testing error (RMS value)	Average percentage error
0.0349	0.0287	1.78%
0.0347	0.0294	2.01%
0.0348	0.0320	2.33%



Results from radial basis function neural network approach:

Training error(RMS value)	Testing error (RMS value)	Average percentage error
0.0601	0.0475	3.50%
0.0603	0.0424	3.09%
0.0600	0.0444	3.27%



Reference:

[1] Grzegorz Dudek, Pattern similarity-based methods for short-term load forecasting, Applied Soft Computing 37 (2015) 277–287, Elsevier, August 2015.

[2] Ming-Yue Zhai, “A new method for short-term load forecasting based on fractal interpretation and wavelet analysis”, Electrical Power and Energy Systems 69 (2015) 241–245, Elsevier, February 2015.

[3] Luis H, Carlos B, Belen AJMC, Jaime S-EAJL, Joaquim M. A survey on electric power demand forecasting: future trends in smart grids, microgrids and smart buildings. IEEE Commun Surveys Tutorials 2014; 16(3):1460–95.

[4] Hernandez L, Baladrn C, Aguiar J, Calavia L, Carro B, Sanchez-Esguevillas A, et al. Artificial neural network for short-term load forecasting in distribution systems. Energies 2014;7(3):1576–98.

[5] S.Fan, R.J. Hyndman, “Short-term load forecasting based on a semi-parametric additive model”, IEEE Trans. Power Syst. 27 (1) (2012) 134–141.

[6] H. Kebriaei, B.N. Araabi, A. Rahimi-Kian, “Short-term load forecasting with a new non symmetric penalty function”, IEEE Trans. Power Syst. 26 (4) (2011) 1817–1825.

[7] V. H. Hinojosa and A. Hoese, “Short-Term Load Forecasting Using Fuzzy Inductive Reasoning and Evolutionary Algorithms”, IEEE Transaction on Powers Systems, Vol.25, February 2010.

[8] Ying Chen, Peter B. Luh, Yige Zhao, Laurent D. Michel, Matthew A. Coolbeth, “Short-Term “Load Forecasting Similar Day-Based Wavelet Neural Networks”. IEEE transactions on power systems, Vol.25, No.1, February 2010.

[9] Mohammed K. Abd, “Electricity Load Forecasting based on Wavelet Neural Network Technique”, American Journal of Applied Sciences 6 (5): 970-973, 2009, ISSN 1546-9239© 2009 Science Publications.

[10] F.J. Nogales, J. Contreras, A.J. Conejo, R. Esp´ınola, Forecasting next-day electricity prices by time series models, IEEE Trans. Power Syst. 17 (2) (2002) 342–348.

[11] L.A. Zadeh, The roles of soft computing and fuzzy logic in the conception, design and deployment of intelligent systems, in: Proceedings of the 6th IEEE International Conference on Fuzzy Systems, Barcelona, Spain, 1997.

[12] J. Contreras, R. Esp´ınola, F.J. Nogales, A.J. Conejo, ARIMA models to predict next-day electricity prices, IEEE Trans. Power Syst. 18 (3) (2003) 1014–1020.

[13] C.P. Rodriguez, G.J. Anders, Energy price forecasting in the Ontario competitive power system market, IEEE Trans. Power Syst. 19 (1) (2004) pp. 366–374.

- [14] R.C. Garcia, J. Contreras, M. van Akkeren, J.B.C. Garcia, A GARCH forecasting model to predict day-ahead electricity prices, *IEEE Trans. Power Syst.* 20 (2) (2005) pp 867–874.
- [15] A.J. Conejo, M.A. Plazas, R. Espínola, A.B. Molina, Day-ahead electricity price forecasting using the wavelet transform and ARIMA models, *IEEE Trans. Power Syst.* 20 (2) (2005) 1035–1042.
- [16] G. Gross, F.D. Galiana, Short-term load forecasting, *Proc. IEEE* 75 (12)
- [17] H.S. Hippert, C.E. Pedreira, R.C. Souza, Neural networks for short-term load forecasting: A review and evaluation, *IEEE Trans. Power Syst.* 16 (1) (2001) 44–55.
- [18] A.J. Wang, B. Ramsay, A neural network based estimator for electricity spot-pricing with particular reference to weekend and public holidays, *Neurocomputing* 23 (1) (1998) 47–57.
- [19] B.R. Szkuta, L.A. Sanabria, T.S. Dillon, Electricity price short-term forecasting using artificial neural networks, *IEEE Trans. Power Syst.* 14 (3) (1999) 851–857.
- [20] F. Gao, X. Guan, X.-R. Cao, A. Papalexopoulos, Forecasting power market clearing price and quantity using a neural network method, in: *Proceedings of the IEEE Power Engineering Society Summer Meeting, Seattle, WA, 2000*, pp. 2183–2188.
- [21] L. Zhang, P.B. Luh, K. Kasiviswanathan, Energy clearing price prediction and confidence interval estimation with cascaded neural networks, *IEEE Trans. Power Syst.* 18 (1) (2003) 99–105.
- [22] L.A.F.M. Ferreira, T. Andersson, C.F. Imparato, T.E. Miller, C.K. Pang, A. Svoboda, A.F. Vojdani, Short-term resource scheduling in multi-area hydrothermal power systems, *Electr. Power Energy Syst.* 11 (3) (1989) 200–212.
- [23] J.P.S. Catalão, S.J.P.S. Mariano, V.M.F. Mendes, L.A.F.M. Ferreira, Parameterisation effect on the behaviour of a head-dependent hydro chain using a nonlinear model, *Electr. Power Syst. Res.* 76 (6/7) (2006) 404–412.
- [24] V.M.F. Mendes, S.J.P.S. Mariano, J.P.S. Catalão, L.A.F.M. Ferreira, Emission constraints on short-term schedule of thermal units, in: *Proceedings of the 39th International Universities Power Engineering Conference, Bristol, UK, 2004*, pp. 1068–1072.
- [25] O.B. Fosso, A. Gjelsvik, A. Haugstad, B. Mo, I. Wangensteen, Generation scheduling in a deregulated system. The Norwegian case, *IEEE Trans. Power Syst.* 14 (1) (1999) 75–80.

DESIGN FAILURE MODE EFFECT ANALYSIS OF A CENTRIFUGAL OIL CLEANER AND PLAN FOR VALIDATION OF THE DFMEA

A.P.Shrotri¹, Satyjit Chitale², N.V.Hargude³, G.S.Joshi⁴, A.R.Dandekar⁵

^{1,3}Associate Professor, Department of Mechanical Engineering,, PVPIT, Budhgaon, Sangli. (M.S)

²Technical Director, Bhagyashree Accessories Pvt. Ltd. Pune (M.S.)

⁴Associate Professor, DKTE'S Textile and Engineering Institute, Ichalkaranji. (M.S.)

⁵Asst. Professor, Department of Mechanical Engineering PVPIT, Budhgaon, Sangli. (M.S.)

Email: amod_shrotri@rediffmail.com¹

Abstract

In present competitive environment owing to the globalization the customers are becoming very choosy and cautious about quality, cost, service and timely deliveries regarding their requirements. Quality and Reliability are the crucial factors in the satisfaction of Customers. Top managements now days are committed to the efforts required in achieving customer satisfaction. The paradigm is shifting from profit making to customer satisfaction. Today the word reliability has become a watch word in the fields of product design and manufacturing engineering. To achieve the quality and reliability at the satisfaction level of the Customer, FMEA is a significant tool.

Failure Mode Effect Analysis is an effective tool popularly utilized by the designers to average out the risks of failures in the product development. The FMEA is concerned with study of both Design failures and Process failures. Design Failure Mode Effective Analysis (DFMEA) and PFMEA(Process Failure Mode Effective Analysis) are meticulously carried out while carrying out the procedure of the FMEA .We have to calculate the Risk Priority Number(RPN).But it is necessary to validate the FMEA by using the experimentation methods. Because it can be possible that we have calculated Higher RPN for some cases, and in actual there may be no effect on actual performance.

This paper discusses about the Failure Mode Effective Analysis applied to Design & Development of Centrifugal oil cleaner which is the crucial part used for filtration of oil in Diesel Generator sets. and validation plan of the DFMEA

Key words: Customer satisfaction, Reliability, APQP ,FMEA, DFMEA, Risk priority no.

Introduction

In present competitive environment owing to the globalization the customers are having wide choices for their requirements. They are becoming very choosy and cautious about quality, cost, service and timely deliveries regarding their requirements. Customers always want that the products they purchase must be reliable. Reliability from their point of view means that the products should meet their requirements for a considerable time.

Quality and Reliability are the crucial factors in the satisfaction of Customers. Hence the organizations throughout the world are striving

for these contemporary measures of performance. It is now mandatory for the organization from survival point of view to fulfill the demands of Customers and to satisfy them.

Top managements now days are committed to the efforts required in achieving customer satisfaction. The paradigm is shifting from profit making to customer satisfaction.

It has now to be the desire as well as the prime duty of the manufacturers that whatever they produce should be reliable and fulfill the customer's expectations. For this purpose manufacturers continually redesign their

products and refine them to eliminate the defects and discrepancies related with their products. Today the word reliability has acquired a highly specialized technical meaning in relation to the control of the quality of the manufacturer products. It has become a watch word in the fields of product design and manufacturing engineering.

To achieve the quality and reliability at the satisfaction level of the Customer, FMEA is a significant tool. FMEA can be defined as the step by step analysis for identifying all possible failures in design, manufacturing or assembly process or a product or service. It is a methodology to detect the potential reliability problems in early stage of development.

Failure modes and effects analysis (FMEA) is a thorough analysis of the malfunctions that can be produced in the components of an engineering system. The thrust is on how to redesign the components to improve system reliability.

Failure mode effect analysis (FMEA)

In today's competitive environment, it is necessary for the organization to fulfill the demands of Customers and to satisfy them. Quality and Reliability are the crucial factors in the satisfaction of Customers. To achieve the quality and reliability at the satisfaction level of the Customer, FMEA is a significant tool.

Failure modes and effects analysis (FMEA) is a step-by-step approach for identifying all possible failures in a design, a manufacturing or assembly process or a product or service. It is a methodology to detect the potential reliability problems in early stage of development. Failures are any errors or defects, especially ones that affect the customer and can be potential or actual. "Effects analysis" refers to studying the consequences of those failures.

The FMEA is typically being used;

- i) For the development of a new product
- ii) When the existing product or process is to be reengineered
- iii) Analyzing failures of an existing process, product or service.

Types of FMEA

Engineering risk can be considered the link between technological growth and social values as they are reflected in public policy. Risk assessment has become increasingly important in engineering design as the complexity of engineering systems has increased. The risks

associated with engineering systems do not arise because risk avoidance was ignored in the design. One category of risks arises from external factors that were considered acceptable at the time of design. This calls for effective utilization of FMEA. FMEA should always be done whenever failure means potential harm or injury to the user. It can be used for figuring out the potential harm or injury to the user due to product/process/design.

The following are the different types of FMEA;

- i) System FMEA:- It Concentrates on system functions . It is a thorough analysis of the malfunctions that can be produced in the components of an engineering system.
- ii) Design FMEA:-Focuses on components and subsystems of a system/product and an exhaustive study of all possible failures in design is done.
- iii) Process FMEA:-Focuses on manufacturing and assembly processes for identifying all possible failures in a manufacturing or assembly process of a product.
- iv) Service FMEA:-Focuses on possible failures in a design and execution of service function.
- v) Software FMEA:- It is a thorough analysis of the malfunctions in the software function.

Significance of FMEA

FMEA is a methodology for analyzing potential reliability problems in the product/process/service in the early development stages which makes it easier to take actions to overcome the related risks, thereby enhancing reliability through design. FMEA is used to identify potential malfunctions, determine their effects on the operation of the product and to identify remedial actions to extinguish the possible failures.

The purpose of the FMEA is to take action to eliminate or reduce failures, starting with the highest-priority ones.

Prioritization of failures is done according to their serious consequences, frequency of occur and ease in detection.

Use of FMEAs in the design process allows the designers to drive out probable failures and produce reliable, safe and customer delighting products. FMEAs allow to utilizes past experience and historical Information for use in future product improvement. It also documents current knowledge and actions about the risks of failures for use in continuous improvement

Ideally, FMEA begins during the earliest

conceptual stages of design and continues throughout the life of the product or service, to prevent failures and subsequently establish control, both before and during the ongoing operation of the process.

FMEA Methodology

- Select the product or process and describe the function.
- Draw the block diagram of product or process.
- Prepare the worksheet which includes name of the product, process, date, function etc.
- List the components, processes.
- Try to find out the potential failures.
- Write the failures in technical terms.
- Describe the effects and severity of each failure.
- Try to find out causes of potential failures.
- Find out the probability of occurrence of each failure mode cause.
- Describe the current prevention techniques if any.
- Find out the possibility of detection of failure mode.
- Calculate Risk Priority Number
- Suggest the preventive actions for the failures having high RPN
- Implement recommended actions.

Benefits of FMEA

1. Early identification and elimination of potential product/process failure modes.
2. Emphasizes problem prevention.
3. Documents risk and actions taken to reduce risk
4. Prioritize product/process deficiencies.
5. Improve product/process reliability and quality.
6. Provides focus for improved testing and development.
7. Increase customer satisfaction.
8. Capture engineering/organization knowledge.
9. Minimizes late changes and associated cost.
10. Promote for teamwork and inter-functional co-operation.

Case study

The Company and the product :-

M/S Bhagyashree Accessories Pvt. Ltd. Pune INDIA is an SME engaged in manufacturing of Automobile accessories. They are the manufacturers of Centrifugal oil cleaners and Automotive Filters. The main function of Centrifugal oil cleaner is to clean the used oil. Generally it is used on DG sets, which is a stationary application.

The Need of FMEA

The company is engaged in manufacturing of Centrifugal oil cleaner generally used on DG sets, which is a stationary application. However as per the requirement of Customer they have to design a new product of the said group for road transport application.

The Technical Director Mr. Satyajeet Chitale has supported the idea of new product development using APQP.

For the APQP methodology implementation ,FMEA , PPAP, and control plan are the essentials.Hence it becomes essential to prepare the DFMEA & PFMEA for the newly developing product.

The Procedure for DFMEA / PFMEA

FMEAs allow to utilizes past experience and historical Information for use in future product improvement. It also documents current knowledge and actions about the risks of failures for use in continuous improvement. Hence it was decided to utilize the available data for similar existing product to identify potential malfunctions, determine their effects on the operation of the product and to identify remedial actions to extinguish the possible failures.

For the preparation of DFMEA & PFMEA, The Customer complaints were analyzed. With the help of this repeatedly rejected components and their causes were identified. There are five components of the assembly, regarding which most of the complaints are registered. These components are specially considered while the preparation of DFMEA& PFMEA.

The sample FMEA of Assembly and shaft is attached in the annexure I & II . The risk priority numbers are calculated and prevention and detection stages are also mentioned

Plan for validation :

Despite of utmost care taken by the designers sometimes the FMEA shows higher side estimation of risks as it involves subjective

Sr.	Controlling Factor	Level 1	Level 2
A	Valve plunger diameter	Oversize	Undersize
B	Shaft diameter	Oversize	Undersize
C	Shaft drilling hole	Oversize	Undersize
D	Shaft Hardness	Excess	Less
E	Rotor diameter	Oversize	Undersize
F	Housing diameter	Oversize	Undersize
G	Housing threading	Tight	Loose

treatment and human judgement based on personal experience and feelings, hence It is essential to validate the DFMEA/PFMEA outcomes. Some of the potential causes are,
 I) Assignment of unnecessary higher risk leading to higher risk priority number for some function. But in actual practice it may not turn out.
 II) Allocation of lower value of RPN to an entity which may lead to potential failure.

The controlling factors :-

For the validation the failure modes showing RPN above 70 were concentrated on and the associated controlling factors were listed down with their extreme levels as shown in **Table 1**.

The Design of Experiment :-

To understand the contribution of the controlling factors in the risk involved in operations it is necessary to design the experimentation of the products assembled from the components showing level 1 and level 2 of the controlling factors, and conducting actual performance trials.

To avoid unnecessary experimentation involving two factorial methods, dealing with two variations in one experiment and thereby calling for 128 trial runs it is decided to go for Taguchi method. Considering the seven controlling factors Considering these factors Taguchi Array for OA-8 is prepared as shown in **table.2**

**Table no.1
CONTROLLING FACTORS**

**Table no.2
Taguchi's Orthogonal Array**

Combination Trial No.	A	B	C	D	E	F	G
1	1	1	1	1	1	1	1
2	1	1	1	2	2	2	2
3	1	2	2	1	1	2	2
4	1	2	2	2	2	1	1
5	2	1	2	1	2	1	2
6	2	1	2	2	1	2	1
7	2	2	1	1	2	2	1
8	2	2	1	2	1	1	2

The experiments were conducted accordingly. The results of experimentation were also showing interaction of controlling factors with each others.

Conclusion:- To achieve the quality and reliability at the satisfaction level of the Customer. Failure Mode Effect Analysis is an effective tool popularly utilized by the designers to average out the risks of failures in the product development. FMEA begins during the earliest conceptual stages of design and continues throughout the life of the product or service, to prevent failures and subsequently establish control.

Despite of utmost care taken by the designers during FMEA, sometimes owing to subjective treatment and human judgement based on personal experience and feelings, there are chances for miss- allocation of risks leading to incorrect Risk Priority Nos.(RPN). Normally it tends to higher side leading to unnecessary fear and over cautious approach both from manufacturer's and consumer's point of view. Hence it is always desirable to validate the FMEA outcomes which are nothing but RPNs. And thereby reaching toward factual data reflecting the reliability of the product.

REFERENCES;-

[1] Junichi Tomita, 'Customer system orientation in the new product development process' World Conference on POM and 15th Annual POM Conference, Cancun, Mexico, April 30 –May 3, 2004.

[2] Prof.A.P.Shrotri,Mr.A.R.Dandekar “PPAP an effective tool in vendor quality management”, International Journal of Emerging Technology and Advanced Engineering,,Volume2-Issue4.April2012,Pg.369-372

[3] Komsan Sanongpong, “Automotive process based new product development –A review key of performance metrics”, Proceedings of the word congress on Engineering, ISBN 978-988-17012-5-1vol I,2009

[4] AgungSutrisno, Tzong-Ru(Jiun-Shen)Lee, “Service Reliability Assessment Using Failure Mode And Effect Analysis (FMEA): Survey And Opportunity Roadmap”, International Journal of Engineering Science and Technology, Volume 3, No 7, 2011, Pages 25-38.

[5] M. Dudek-Burlikowska, “ Application of FMEA method in enterprise focused on quality”, Journal of achievements in materials and manufacturing engineering ,volume 45-issue 1, March 2011 Pg.89-102

[6]Piyush Kumar Pareek, Trupti V Nandikolmath1 and Praveen Gowda, “FMEA implementation in a foundry in Bangalore to improve quality and reliability”, International journal of Mechanical Engineering and Robotics Research, Vol 1 , Issue no. 2, 2012,Pg.82-87

[7] Jesus Gerado, Cruz Alvarez, “Design for Six Sigma: Approach for reliability and low-cost manufacturing” UANL, ISSN 2007-1191, 2012 ,Pg.319-340

[8]Prof.A.P.Shrotri,A.R.Dandekar,S.B.Khandagale “Essential Requirements of PPAP” ,International Journal of Technological Exploration and Learning, Volume 3-number 3,June2014,Pg.502-505

[9]Prof. A .P .Shrotri, Prof. G.S.Joshi, Prof. S.A.Kore, A.R.Dandekar “A comparative study of APQP and contemporary product design and development stratigies”, International Journal of Mechanical Engineering and Technology,Volume6-issue 1,January2015,Pg.47-55

[10] D.N.P.Murthy, “Product reliability and warranty: an overview and future research”, Publication ofAssociação Brasileira de Engenharia de Produção, ISSN 0103-6513, Sep-Dec2007.

[11] Mike Kolich, “Using Failure Mode and Effects Analysis to design a comfortable automotive driver seat” Journal of applied ergonomics, January 2014,Pg 1087-1096

[12] Poornima M.Charantimath, “Total Quality Management, Pearson publication, second edition 2011 ISBN978-81-317-3262-5.

[13] Kevin Otto et-al, “Product Design-techniques in Reverse Engineering and new productdevelopment”, Pearson publication, first Indian reprint2004, ISBN81-297-0271-1.

[14] Dale H. Besterfield,et.al. “Total Quality Management”, Pearson Education Asia (ISBN 978-81-317-3227-4)

[15] Joseph M. Juran ,A. Blanton Godfrey ,Robert E. Hoogstoel ,Edward G. Schilling “JURAN’S QUALITYHANDBOOK”, Fifth edition,McGraw-Hill New York ,1988

[16] Bhagyashree Accessories Private Limited, “Centrifuge lube oil cleaners for removal of dirt from engine oil”, Automotive Brochure

.Annaxure-I

Sr.	Function	Potential Failure Mode	Potential Effects of Failure	Potential Causes of failure	Severity	Occurrence	Detection	Risk Priority Number
1	Removal of dirt from engine oil.	Oil interval is less than stated.	Centrifuge is not removing the dirt with its full efficiency.	i)Use of the different grade oil than specified	6	4	5	120

				ii) Servicing is not in regular manner.				
2	The centrifuge assembly should be aesthetic	Centrifuge cover coating is not as per specification	Penetration of Filter cover and hence threat to entire assembly	Use of improper coating material for filter cover	5	3	3	45
3	The centrifuge assembly should be in enclosed position	Centrifuge position is not in enclosure	i) Damage to assembly due to external objects.		5	5	5	125
4	Centrifuge operates at specified pressure.	i) Operates before specified pressure.	i) Engine starves of oil	i) Wrong valve setting.	4	4	4	64
		ii) Operates after specified pressure.	ii) No effect		5	4	5	100
		iii) Does not operate at all.	i) Valve plunger jamming due to oversize.		6	6	6	196

**Annaxure-II
FMEA OF SHAFT**

Sr.	Function	Potential Failure Mode	Potential Effects of Failure	Potential Causes of failure	Severity	Occurrence	Detection	Risk Priority Number
1	Tightening of shaft in housing.	Breaking of shaft while doing the assembly or sometimes	i) Stops the operation of filter.	i) Threading is not maintained as per mentioned size. ii) Threading length is not	4	4	3	48

		while functioning.	ii)Damage of entire rotor assembly.	maintained as per mentioned length.				
2	Rotation of the rotor assembly around the shaft.	Sudden breaking of shaft without any indication.	i)Stops the operation of filter. ii)Damage of entire assembly.	i)Case hardening parameter are not followed.	3	6	6	108
3	Tightening of shaft in cover nut.	Breaking of shaft while doing the assembly or while sometimes functioning	i)Stops the operation of the filter ii)Damage of entire rotor assembly	i)Threading is not maintained as per mentioned size. ii)Threading size is not maintained as per mentioned length.	5	3	3	45
4	Smooth rotation of rotor assembly	i)Noise & vibration during operation of rotor assembly	i)Stops the operation of filter, but there are warning signals ii)Damage of assembly with warning signals	i) Diameter of shaft is undersize.	6	4	4	96

AUTOMATIC DETECTION OF ALZHEIMER DISEASE USING EEG MODULATION ENERGY

Alok Pathak

Associate Professor, Dept. of Electrical Engg., IPS-CTM, Gwalior (M.P)

Email: alokpathak77@gmail.com

Abstract

In this paper, a new methodology Spectro-temporal EEG amplitude modulation energy along with an effective artifact removal algorithm, based on Independent Component Analysis (ICA) for diagnosis of Alzheimer disease using EEG signals is proposed; thereby increasing the diagnostic accuracy of the EEG signals & diagnosis. This paper presents it is concluded that EEG can play an important role in diagnosis of Dementia & Alzheimer Disease.

Keywords: Alzheimer, Disease, Dementia, EEG, Spectro-temporal EEG Amplitude Modulation Energy, Spectral Power Based Features

Introduction

Alzheimer Disease is one of the most common & tremendously growing neurological diseases in the world. Electroencephalogram signals (EEG) yields out powerful and relatively cheap tool of diagnosis of different neurological disease. EEG can be used the standardized tool for diagnosis of Alzheimer disease. The Electroencephalogram (EEG) is a tool for measuring the brain activity which reflects the condition of the brain. EEG is very effective tool for understanding the complex behavior of the brain. EEG provides the electrical action potentials produced by cerebral cortex neurons [1]. The EEG detecting machine is a video recording device and linked through wires to electrodes connected at specific points on the head of the patient Various abnormalities are found in the EEG signals of the patients suffering from Alzheimer disease. Hence, the need is to develop the detection of the disease in early stage called as Dementia, the first stage called Mild cognitive impairment (MCI). Role of EEG in diagnostic & clinical research of Alzheimer disease has become more useful in present decades. In present, the most critical task includes the diagnosis of the AD & its early detection in the preclinical stage. The need is to

improve the diagnosis accuracy of the EEG signal.

Literature Review

Although Cancer & Cardiovascular diseases are one of the most expensive diseases; Alzheimer Disease is now third most expensive disease & the sixth leading cause of death in United States. Basically, Alzheimer Disease (AD), the common form of dementia, is neurodegenerative disorder characterized by a progressive & several loss of memory with cognitive impairment [1] [2]. The prevalence of the disease in the world is assumed to double in next 20 yrs [3]. Alzheimer Disease is assumed to increase in future mainly due to aging phenomenon. There are no early symptoms which can be reliable & valid to diagnose the disease in early stage. In the mild stage of the Alzheimer Disease, loss & impairment of memory is noticed. As the disease progresses, several deficits are observed in cognitive abilities such as judgment, abstract or logical planning & organizing [5]. In the ultimate stage of disease, termed as Severe Alzheimer Disease (AD), almost all the cognitive functions are severely damaged along with motor functions such as chewing & swallowing [6]. According to the World health Organization report, it was estimated that there are 44.4

millions of people suffering from Dementia & Alzheimer Disease in the world. It is also expected that this number will increase till 75.6 million in 2030, and 135.5 million in 2050. It is observed that 61% of the people suffering from dementia are from developed countries. The fastest growth of the disease is taking place in India, China, and South Asian & Western pacific countries [7]. From the above survey done, we can conclude that it is essential to diagnose the Alzheimer Disease in early stage. The early diagnosis of disease is essential since medications can be given in early stage of disease. The early diagnosis of the disease also allows the patients family to take financial decisions related to the disease & plan for the future needs & care of the patients.

Numerous clinical methods are extensively used for the diagnosis of Alzheimer disease such as neuroimaging techniques, physiological markers, and genetic analyses. Neuroimaging is one of the well-accepted methods for definitive diagnosis of dementia. Various Neuro -imaging methods are used for the diagnosis of the Alzheimer disease. Several methods such as single-photon emission computerized tomography (SPECT), positron emission tomography (PET), and magnetic resonance imaging (MRI) have been successful for

recognizing AD at an early stage. But the main problem of PET & SPECT is they impose the radiation risks. Other disadvantages are their costs; which are much expensive, time consuming & inconvenient. So, apart from all these Neuro-imaging methods; EEG is one of the standard methods used for the diagnosis of the Alzheimer disease.

Electroencephalography is considered as one of the important and cheap tool for diagnosis of different neurological disorders such as Parkinson's, Epilepsy, Dementia & Alzheimer etc [9] [10]. Electroencephalography is Non-invasive, repeatable, & cheap tool for diagnosis of different neurological disorders. EEG directly correlates the brain function which is clinically for monitoring the brain activity. Different linear & non-linear analysis of sampled EEG signals gives us the unique features to reveal the diagnosis of neurological diseases.

Along with the above techniques, Electroencephalogram signals have high temporal resolution and several abnormalities are observed in EEG signal of the patients suffering from different neurological disorders. The table.1 shows the various methods & features used by the researchers for Electroencephalogram based diagnosis of Alzheimer disease.

Table 1
Comparative Study of various techniques developed By Researchers

Sr. No	Reference	Methods Used	Accuracy
1.	[17]	Independent Component Analysis (ICA)	60%
2.	[20]	Spectral Power Density	80%
3.	[13] [14]	Tsallis Entropy	82%

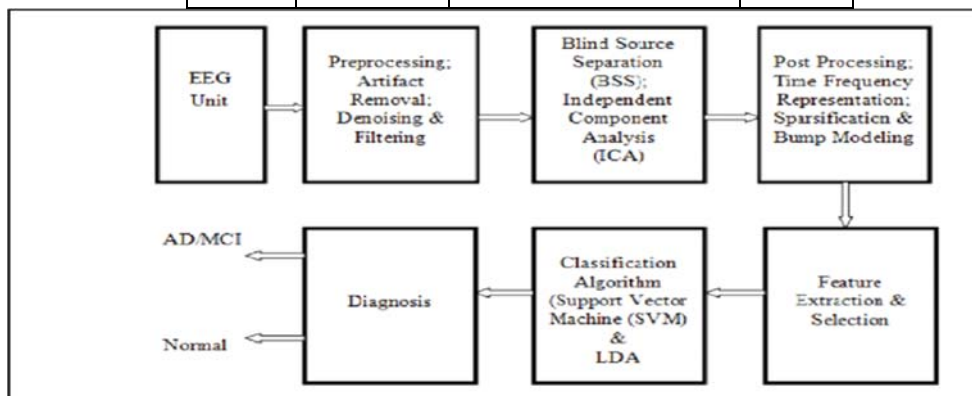


Fig. 1: Block diagram of Proposed System

PROPOSED METHODOLOGY

Let us discuss the proposed methodology in more detail.

(a) **EEG Acquisition:** The EEG signal will be acquired using EEG electrode cap placed on the patients head using International 10-20 system. The EEG acquisition kit will be used for displaying the EEG signal to computer in digital format [8].

(b) **Pre-processing:** It includes the noise removal from raw EEG signal. Basically, Pre-processing of EEG signal involves amplification, filtering of signal & artifact removal. To obtain more enhanced EEG signal, various techniques are used such as Blind Source separation (BSS) [17], Independent Component Analysis (ICA) [18] etc. Once the signal is cleaned, it is converted in frequency domain. This is called post preprocessing of EEG signals. Wavelet transform (DWT), Sparsification & Bump modeling are used for post pre-processing of EEG signals.

(c) **Feature Selection & Extraction:** In this process, some certain features of signal obtained are extracted from pre- processed EEG signal. The feature comprises of certain frequency bands of power spectrum. Various features of EEG signal can be extracted such as Spectral power, variations in EEG amplitude & frequency, measure of spatial synchronization etc. The above features can be calculated using various techniques such as Fast Fourier Transform (FFT), Discrete Wavelet Transform (DWT) etc.

(d) **Classification:** The features in the previous part are the input to the classifier. The classifier is a linear model or nonlinear model which will be trained to diagnose the disease. In our proposed research work, different algorithms will be used & tested such as Linear Discriminant Analysis (LDA), Support Vector machine (SVM), K-means Clustering, Artificial Neural Networks (ANN) etc, to compare the diagnostic accuracy of the signal & classifier used.

(e) **Diagnosis:** Depending on the output of the classifier, we will be in the situation to detect whether the patient is suffering from Alzheimer disease. Depending on the features used, we can also detect the stage of the disease. (EEG) is the recording of electrical activity along the scalp produced by the firing of neurons within the

brain. These activities can be decoded by signal processing techniques, however, they are typically influenced by extraneous interference, like muscle movements, eye blinks, eye movements, background noise, etc. Therefore, a preprocessing step to remove artifacts is extremely important. This paper presents an effective artifact removal algorithm, based on Independent Component Analysis (ICA)

Independent Component Analysis (ICA)

The first step in our proposed algorithm is the ICA transform. ICA is a computational method for separating a multi-channel signal into additive subcomponents supposing the mutual statistical independence of the non-Gaussian source signals. Assume that we observe an array of electrodes that provide a vector of N channel signals $\mathbf{v}(t)=[v_1(t), v_2(t), \dots, v_N(t)]^T$ that are linear combinations of N unknown and statistic independent sources $\mathbf{s}(t)=[s_1(t), s_2(t), \dots, s_N(t)]^T$.

When applying the ICA to the EEG signals, the resulting independent components represent the event-related potentials and non-event-related sources (including artifacts). This makes the ICA to be an effective method for removing the artifacts. The inverse matrix W^{-1} gives the relative projection strengths of the respective components to each of the scalp electrodes, which will be used as features for further clustering. These inverse weights define the scalp topography of each component, and provide the evidence for the components' physiological origin.

Several ICA algorithms have been implemented and are publicly available. In this paper, we use the Fast ICA algorithm in the EEGLAB [24] to transform the original multi-channel EEG signals into ICs.

EEGLAB & MATLAB toolbox will be used for processing of Electroencephalogram signal. EEGLAB is found to be an interactive MATLAB toolbox which will be used for processing the continuous & event related EEG data [19]. Using Independent component analysis (ICA), time/frequency analysis, EEGLAB also provides an interactive graphics user interface (GUI) allowing users to flexibly and interactively process their high density EEG data. Thus, MATLAB will be used as the

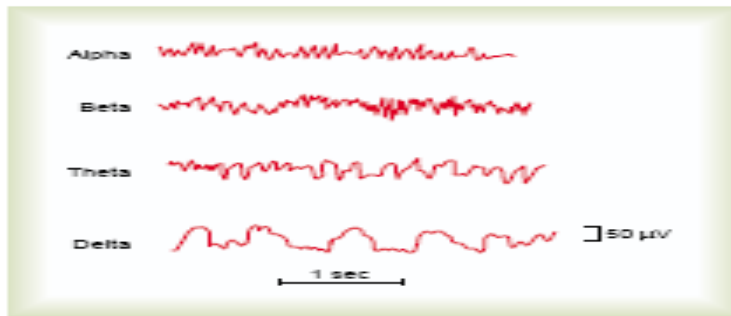
software tool for evaluating the pre-processing, feature extraction & classification algorithms.

FEATURES USED FOR DIAGNOSIS OF ALZHEIMER DISEASE USING EEG SIGNALS.

There exist different features for diagnosis of Alzheimer disease in literature. Features play a significant role in automated diagnosis of Alzheimer Disease. Let us now discuss the different features which can be used for diagnosis of Alzheimer Disease.

A. Spectro-temporal EEG amplitude modulation energy It is the novel feature for AD diagnosis which quantitatively monitors EEG amplitude modulation [22] [23]. The feature is termed as 'EEG spectro-temporal

modulation energy'. The following are the different steps involved in its computation. Firstly, the full-band EEG signal is decomposed into five well-known sub-bands: delta (0.1 - 4 Hz), theta (4 - 8 Hz), alpha (8 - 12 Hz), beta (12 - 30 Hz) and gamma (30 - 100 Hz). The Temporal envelope of each sub-band signal is computed by means of a Hilbert transform. In order to quantify the rate of change of the sub-band temporal envelopes, further decomposition of the envelopes into the five modulation bands is done and then the energy computation is done present in each modulation band. In the resulting spectral modulation techniques, rate of change in the information for each sub-band amplitude envelope is observed.



Along with the same, the frequency range of modulation bands are empirically set to coincide with the frequency range of conventional bands. To distinguish between the two modulation bands are appended by a prefix 'm' (e.g. m-delta, 0.1 - 4 Hz; m - theta, 4 - 8 Hz) etc. The feature of this represents the percentage of overall modulation energy present in each of the five frequencies and five modulation frequencies [22] [23].

Methods for EEG Data collection/simulation

In the above study total 650 modulation energy features can be extracted per epoch per participant. So, total 25 features for total 19 channels & including 7 bipolar channels. So total we can compute the $25 * (19 + 7) = 25 * 26 = 650$ features per AD patient. The placement of the EEG electrodes consist of International 10-20 system for bipolar referential electrodes & it can be used for recording of the EEG signals of

19 channels namely Fp1, Fp2, F3, F4, F7, F8,

C3, C4, T3, T4, T5, T6, P3, P4, O1, O2, Cz, Fz, Pz. An EEG bipolar signal can be obtained by subtracting the two bi-auricular referenced signals involved. The commonly used bipolar signals include F3-F4, F7-F8, C3-C4, T3-T4, P3-P4, T5-T6, and O1-O2. The following figure shows EEG electrode placement according to the International 10 - 20 systems

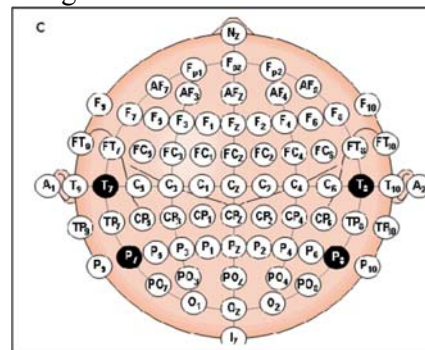


Fig. 3 International 10 - 20 EEG Electrode Placement System

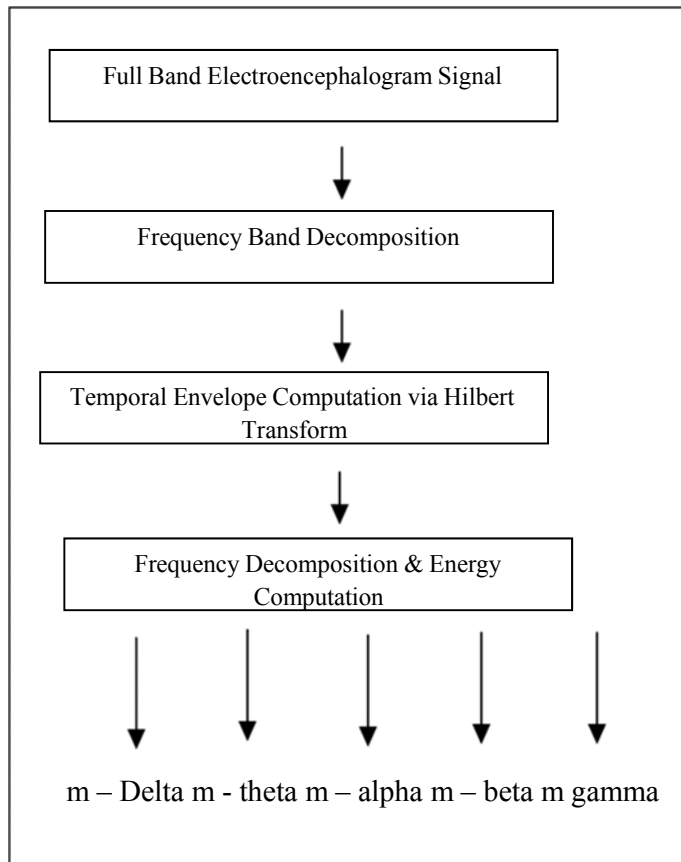


Fig.4 Spectro -temporal EEG amplitude modulation Energy

Thus, the Spectrum of the EEG signals can show a difference in power for AD patients, Dementia patients & normal patients. Thus, *Spectro-temporal EEG amplitude modulation energy* based features plays a significant role in diagnosing in Alzheimer Disease.

Conclusion

At the end, it is expected that we will obtain the high accuracy of EEG signal for diagnosis of Alzheimer Disease . By observing the *Spectro-temporal EEG amplitude modulation energy* based features of the EEG signal, classified according to the different frequency band & depending upon the output of the classifier and applying effective artifact removal algorithm, based on Independent Component Analysis (ICA) we will be in the position to detect the Alzheimer Disease with high accuracy up to 95% in early stage. The future work includes the more automatic tools for artifact removal of EEG signals and applying the algorithms on large datasets for increasing the accuracy of EEG signals. Several

automatic artifact removal techniques such as principal component analysis (PCA), can be used to make the system completely automatic. Thus, early diagnosis of disease can help us to take preventive measures to control the disease in early stage.

REFERENCES

- [1] Mattson M., —Pathways towards and away from Alzheimer's disease, *Nature*, Vol. 430, pp. 631–639, Aug.2004.
- [2] Meek P.D., McKeithan K., and ShumockG.T., —Economics considerations of Alzheimer's disease , *Pharmacotherapy*, Vol. 18, pp.68–73, March-April 1998,
- [3] World Health Organization and Alzheimer's disease International (2012) *Dementia: a public health priority*, Technical report.
- [4] De Carli C, Kaye JA, Horwitz B,Rapoport SI., —Critical analysis of the use of computer-assisted transverse axial tomography to study human brain in aging and dementia of

- the Alzheimer type. , *Neurology*, Vol .40, 1990,pp. 872–83.
- [5] D. Foerstl H, Kurz A., —Clinical features of Alzheimer’s disease. *Eur ArchPsychiatry Clin Neurosci*, Vol.249, pp.288– 90, 1999.
- [6] Bianchetti A, Trabucchi M., —Clinical aspects of Alzheimer’s disease. *AgingClin Exp Res*, Vol 13, pp. 221–230, 2001.
- [7] Béatrice Duthey, —A Public Health Approach to Innovation , Update on 2004 Background Paper written by SaloniTanna, February 2013.
- [9] Beuter, C. Labric, and K. Vasilakos, —Transient dynamics in motor control of patients with Parkinson’s disease, *Chaos*, vol.1, 1991, pp. 279-286.
- [10] H. L. Glass, —Nonlinear dynamics of physiological function and control, *Chaos*, vol. 1, pp. 247-250, 1991.
- [11] Justin Dauwels, Francois Vialatte, and Andrzej Cichocki, “Diagnosis of Alzheimer’s disease from EEG Signals: Where Are We Standing?” *Current Alzheimer Research*, Vol. 7 Issue 6, pp. 487-505, September 2010.
- [12] Cover T. M. and Thomas J. A., —Elements of Information Theory. Wiley, New York, 1991.
- [13] Pincus S.M., —Approximate entropy as a measure of system complexity , *Proc.Natl Acad Sci, USA*, Vol 88, pp. 2297–2301, March 1991.
- [14]Lake D.E., Richman J.S, Griffin M.P., and Moorman J.R.,—Sample entropy analysis of neonatal heart rate variability , *Am J Physiol*, Vo..283, No. 3, pp. 789–797, Sep 2007.
- [15] Costa M., Goldberger A.L., Peng C.-K., —Multiscale entropy analysis of physiologic time series. *Phys Rev Lett*, Vol.89, No.06, August 2002.
- [16] Andrzej Cichocki, Sergei L. Shishkin, ToshimitsuMusha, Zbigniew Leonowicz , Takashi Asada, Takayoshi Kurachi, —EEG filtering Based on blind source separation (BSS) for early detection of Alzheimer’s disease , *Clinical Neurophysiology*, Vol 116, No.3, pp.729-737, March 2005.
- [17] Co Melissant, Alexander Ypma, Edward E.E. Frietman, Corn elis J.Stam, —A method for detection of Alzheimer’s disease using ICA enhanced EEG measurements , *Artificial Intelligence in Medicine*, Vol. 33, No.3, pp. 209-222, March 2005.
- [18] Latchoumane C.F.V, Vialatte F.B., Jeong J., and Cichocki A. EEG Classification of Mild and Severe Alzheimer’s Disease using Parallel Factor Analysis Method. In *Advances in Electrical Engineering and Computational Science*, in press, 2009.
- [19] Arnaud Delorme, Scott Makeig, “EEGLAB: an open source toolbox for analysis of single-trial EEG dynamics including independent component analysis”, *Journal of Neuroscience methods*, Vol.134, pp. 9-21, 2004.
- [20] Jaeseung Jeong, —EEG dynamics in patients with Alzheimer’s disease, *Artificial Intelligence in Medicine*, Vol 33, Issue 1 pp. 209—222, 2005.
- [21] Simon-Shlomo Poil, WillemdeHaan, Wiesje M.vAnder Flier, HuibertD.Mansvelder Philip Scheltens and KlausLinkenkaer- Hansen, Integrative EEG biomarkers predict progression to Alzheimer’s disease at the MCI stage , *Frontiers in Aging Neuroscience*, Vol.5, Oct 2013, pp. 1-6, Article ID 58.
- [22]Raymundo Cassani, Tiago H. Falk, Francisco J.Fraga, Paulo A.M. Kanda and Renato Anghinah, “The effects of automated artifact removal algorithms on electroencephalography-based Alzheimer’s disease diagnosis”, *Frontiers in Aging Neuroscience*, Volume 6, Article 55, pp. 1 – 13, March 2014.
- [23]Lucas R. Traimboli, Tiago H. Falk, Francisco J. Fraga, Renato Anghinah, Ana C. Lorena, “EEG Sepectro-Temporal Modulation Energy: a New Feature for Automated Diagnosis of Alzheimer Disease”, in *Proc Intl Conf IEEE-EMBC*,1, Boston, USA,
- [24]A. Hyvarinen and E. Oja, “Independent component analysis: algorithms and applications,” *Neural networks*, vol. 13, no. 4-5, pp. 411– 430, 2000.

AN INNOVATIVE TECHNIQUE FOR ROAD CONSTRUCTION BY WASTE PLASTIC

Rahul Singh Yadav¹ R. K. Batra²

¹PG Student, Dept. of Civil Engineering, IPS-CTM, Gwalior (M.P)

²HOD, Dept. of Civil Engineering, IPS-CTM, Gwalior (M.P)

Email: rahulsinghyadav841@gmail.com¹, headce.ips@gmail.com²

Abstract

The plastic waste has been increasing day by day due to increase in population, urbanization, industrialization, changes in the life style, and socio-economic conditions. The disposal of plastic waste is a menace and become a serious problem worldwide due to its non-biodegradability and unaesthetic view. It is need of the hour to use plastic waste for construction of flexible pavement to minimize the bitumen consumption, manage the plastic waste and improve the properties of the aggregates. Dry process is the most advanced technique in which plastic waste is used to coat the aggregates. The plastic coated aggregates exhibit improved soundness & specific gravity, less abrasion & impact value and extra resistant to water than that of plain aggregates. In this paper, the use of plastic waste in flexible pavement by using dry process has been examined and the properties of the plastic coated aggregates have been compared with the plain aggregate

Key words: Waste Plastic, Aggregate.

INTRODUCTION

Today, for the developing countries, Flexible pavements are one of the most important infrastructures. Any damage to this may cause lots of inconvenience to the traffic which ultimately will affect the future scenario of countries. Now-a-days it is been observed that due to increase in axel load and traffic intensity the capability of the bituminous binders is been reduced causing bleeding in hot climate, cracks in cold climate, rutting and pot holes. This makes an essentiality in modification of bitumen binder to meet the increasing demand of axel loads and traffic intensity. Rapid industrial and enormous population growth has resulted in increasing the various types of waste materials. Considerable measures have been done for the disposal of these waste products. These plastics are considerably non-biodegradable thus can be used as a modifier in bitumen and aggregates to increase their strength. This study presents the proper utilization of waste in hot bitumen and aggregate to enhance pavement performance, to protect environment and to provide low cost

roads.

LITERATURE REVIEW

The concept of using plastic in flexible pavement has been done since several years ago in India. Plastic has played a very vital role in increasing the strength of bitumen as well as aggregate.

Prof. C.E.G.Justo etc (2002), at the Centre for Transportation Engineering of Bangalore University on the possible use of the processed plastic bags as an additive in bituminous concrete mixes. The properties of the modified bitumen were compared with ordinary bitumen. Similarly, Dr. R. Vasudevan etc. (2004) reported that waste plastic could replace about 8% by weight of bitumen. Stripping test conducted after mixing operation proved that adhesion of the plastic waste to aggregate & bitumen was excellent. Plastic waste could be successfully mixed with aggregates and bitumen at hot mix plant and the condition of the road when properly laid was good.

Vasudevan etc. (2006) reported that though plastic modified bitumen improves the quality of the roads, the process of using the plastic for the

blending decides the strength of the bonding. Rema Devi etc. Stated that the concept of utilization of waste plastic in the construction of pavement has shown better resistance to water which reduces the stripping of bitumen from aggregate.

Amit Gawande etc. investigations the use of waste plastic in road construction as an effective way to reutilize the plastic waste.

Mohammad T. Awwad etc. (2007), polyethylene as one sort of polymers is used to investigate the potential prospects to enhance asphalt mixture properties.

PLASTIC WASTE AND ITS SOURCE

The sources of plastic waste are shown in table 1. The plastic conforming to HDPE, LDPE, PET and polystyrene shall only be used in flexible pavement. The PVC should not be used for road construction as they produce toxic gases and cause health hazards.

Table 1: Plastic Waste and its Source

Plastic waste	Origin/ Source
High Density Polyethylene (HDPE)	Carry bags, bottle caps, house hold articles, etc.
Low Density Polyethylene (LDPE)	Carry bags, sacks, milk pouches, bin lining, cosmetic and detergent bottles, etc.
Polypropylene (PP)	Bottle caps and closures, wrappers of detergent, biscuit, wafers packets, microwave trays for readymade meal, etc.
Polyethylene Terphthalate (PET)	Drinking water bottles, etc.
Polystyrene (PS)	Yoghurt pots, clear egg packs, Bottle caps. Foamed Polystyrene: food trays, egg boxes, disposable cups, protective packa

	ging, etc.
Poly Vinyl Chloride (PVC)	Mineral water bottles, credit cards, toys, pipes and gutters; electrical fittings, furniture, folders and pens, medical disposables, etc.

Table 2: Plastic Consumption in India.

Sr.No.	Year	Plastic Consumption in India (in Tones)
1.	1996	61000
2.	2001	400000
3.	2006	700000
4.	2011	13500000

Table 3: Plastic Waste in World (Per/Capita/Year)

Sr. Nr.	Country/Continent Consumption	Per/Capita/Year in Kg.
1.	India	14
2.	East Europe	10
3.	South East Asia	10
4.	China	24
5.	West Europe	65
6.	North America	90
7.	World Average	25

COST ANALYSIS

Assuming Cost of plastics waste (collection, segregation and processing) = Rs. 5/- per Kg.
 Cost of Bitumen per drum (200 Kg) =10000/-
 Cost of Bitumen per Kg= 50/-
 Cost of bitumen per ton =50000/-
 Generally roads in India are constructed in basic width of 3.75 m.
 Consider 1 Km length road to lay 1km of road 10 tons of bitumen is required,
 Cost of bitumen required per Km= Rs. 5, 00,000
 Assuming Optimum percentage of plastic as per

the test results of literature reviewed is around 10% (by % wt. of bitumen)

Total quantity of bitumen required = 9 tons

Total quantity of plastic waste required = 1 ton

Cost of bitumen for 9 tons = Rs. 4, 50,000

Cost of plastic waste = Rs. 5000

Total cost of bitumen and plastic = Rs. 4, 55,000

Total savings = 5, 00,000 - 4, 55,000 = Rs.45, 000 per Km.

CHARACTERIZATION OF WASTE PLASTICS

Plastic is a good binder

Table 4: Binding Property of Plastic

% of Plastic Coating Over Aggregate	Compressive Strength (mpa)	Bending Strength (mpa)
10%	250	325
20%	270	335
30%	290	350
40%	320	390.

ADVANTAGES OF PLASTIC ROAD

- Use higher percentage of plastic waste.
- Reduce the need of bitumen by around 10%.
- Increase the strength and performance of the road.
- Reduce the cost
- Generate jobs for rag pickers
- Develop a technology, which is eco-friendly.

DISADVANTAGES OF PLASTIC ROADS

- Toxics present in the co-mingled plastic waste would start leaching.
- But the presence of chlorine will definitely release HCL gas.

MARSHAL STABILITY TEST

In Marshal Stability Test, the deformation of specimen of bituminous mixture is measured when the same load is applied. This test procedure is used in designing and evaluating bituminous paving mixes. The marshal stability of mix is defined as a maximum load carried by a compacted specimen.

The following results of Marshal Stability test are

shown in Table 5.

Table 5: Observation for the Marshal Stability

Sr.Nr.	Plastic Added (%)	Stability (kg)
1.	0	1010
2.	5	1680
3.	10	1957
4.	15	1181.23

PENETRATION TEST (IS: 1203-1978)

The penetration test is carried out to know the hardness or softness of bitumen used in road construction by measuring the distance to which the needle penetrates. Samples having different percentage of plastic waste in bitumen is prepared and their penetration values are determined as per IS code. The penetration values of the blends are decreasing depending upon the percentage of polymer added.

As per IRC recommendation the penetration values of Bitumen is from 20-225 mm. The following results of penetration test are shown in Table 6.

Table OBSERVATION FOR PENETRATION TEST

% of Bitumen	% of Polymer	Penetration Value in mm
100	0	70
95	5	68
90	10	67
85	15	64

OUT COME OF REVIEW

It shows that with the increase of waste plastic in bitumen increases the properties of aggregate and bitumen. Use of waste plastic in flexible pavements shows good result when compared with conventional flexible pavements. The optimum use of plastic can be done up to 10%, based on Marshal Stability test. This has added more value in minimizing the disposal of plastic waste as an eco-friendly technique. Coating of polymer on the surface of the aggregate has resulted in many advantages, which ultimately helps to improve the quality of flexible pavement.

CONCLUSION

The main objective of this paper is to discuss the significance of plastic in terms of cost reduction, increase in strength and durability when these plastics are heated and coated upon the aggregates (160°C) to compensate the air voids with plastic and binds with aggregate to provide stability. The polymer coated aggregate bitumen mix forms better material for flexible pavement construction as the mix shows higher Marshall Stability value. Hence the use of waste plastics for flexible pavement is recommended.

SCOPE FOR FUTURE WORK

The Laboratory tests are carried out by adding different percentages of plastic waste. It is given to understand that trial of plastic waste use by replacing 1 to 2 percent Bitumen has been started in rural roads in Madhya Pradesh. The monitoring of those roads is under progress. The capital cost of roads shall decrease, but the examination of maintenance cost is to be done. In addition to this the environmental test for different gas contents is to be carried out after the construction of plastic coated aggregate roads.

REFERENCES

- Justo C.E.G., Veeraragavan A “Utilization of Waste Plastic Bags in Bituminous Mix for Improved Performance of Roads”, Centre for Transportation Engineering, Bangalore University, Bangalore, India, 2002.
- T. Awwad Mohammad and Sheeb Lina The Use of Polyethylene in Hot Asphalt Mixtures, American Journal of Applied Sciences 4 (6) pp-390-396, 2007.
- Vasudevan R., Utilization of Waste Plastics for Flexible Pavement, Indian Highways, Indian Road Congress, Vol. 34, No.7 (2006).
- IRC:SP:98-2013, Guidelines For The Use of Waste Plastic in Hot Bituminous Mixes (Dry Process) in Wearing Courses, Indian Roads Congress (2013).
- Devi R., M, Stephen L., Mini.I.M, (2013) “Reduction Of Optimum Bitumen Content In Bituminous Mixes Using Plastic Coated Aggregates”. International Journal of Innovative Research in Science, Engineering and Technology Vol. 2, Issue 3, March 2013
- Gawande A., Zamare G., Renge V.C., Tayde S., Bharsakale G. (2012) “An Overview On Waste Plastic Utilization In Asphaltting Of Roads” International Journal of Innovative Research in Science, Engineering and Technology

APPLICATION OF THE ANALYTICAL HIERARCHY PROCESS (AHP) IN THE SELECTION OF CONTRACTORS/CONSULTANTS

Agraj Sharma¹, Ramesh Kumar Batra²,

¹PG Scholar, Dept. of Civil Engineering, IPS-CTM Gwalior (M.P)

²H.O.D., Dept. of Civil Engineering, IPS-CTM Gwalior (M.P)

Email agrajsharma03@gmail.com¹, headce.ips@gmail.com²

Abstract

Present paper review about all the aspects of selection of contractor with the Analytical Hierarchy Process (AHP) as a potential decision making method for use in project management. Given that contractor plays a critical role in any construction project, contractor selection constitutes key decision. It is a very important part of project it must be well experienced. A hierarchical structure is constructed for the prequalification criteria. By applying the AHP, the prequalification criteria can be prioritized and a descending order list of contractor can be made in order to select the best contractor to perform the project. A sensitivity analysis can be performed to check the sensitivity of the final decisions to minor changes in judgments. This review presents group decision-making using the AHP. The AHP implementation steps can be simplified by using the computer programming. It is hoped that this will encourage the application of the AHP by project management professionals.

Keywords: Analytical Hierarchy Process (AHP), multiple criteria, contractor/ consultant.

Introduction

The prequalification procedure, i.e. the elimination of incompetent contractors from the selection process according to a predetermined set of criteria, is one of the currently utilized procedures worldwide for contractor selection Palaneeswaran and Kumaraswamy[14], Topcu [22]. Since "it is increasingly recognized that the lowest bid is not necessarily the most economical solution in the long term" Kumaraswamy[11], both the selected criteria and a sound evaluation methodology are essential factors in any contractor selection procedure, including prequalification, in order to assure the ability of selected contractor to achieve simultaneously time, cost, and quality specifications.

The Analytical Hierarchy Process (AHP) is a decision aiding method developed by Saaty [15,

16, 17, 18, 19, and 20]. It aims at quantifying relative priorities for a given set of alternatives on a ratio scale, based on the judgment of the decision-maker, and stresses the importance of the intuitive judgments of a decision-maker as well as the consistency of the comparison of alternatives in the decision-making process [15]. Since a decision-maker bases judgments on knowledge and experience, then makes decisions accordingly, the AHP approach agrees well with the behavior of a decision-maker. The strength of this approach is that it organizes tangible and intangible factors in a systematic way, and provides a structured yet relatively simple solution to the decision-making problems [19]. In addition, by breaking a problem down in a logical fashion from the large, descending in gradual steps, to the smaller and smaller, one is able to connect, through simple paired

comparison judgments, the small to the large.

The objective of this paper is to introduce the application of the AHP in project management. The review the concepts and applications of the multiple criteria decision analysis, the AHP's implementation steps, and demonstrate AHP application on the contractor prequalification. It is hoped that this will encourage its application in the whole area of project management.

Literature Survey

Project managers are faced with decision environments and problems in projects that are complex. The elements of the problems are numerous, and the inter-relationships among the elements are extremely complicated. Relationships between elements of a problem may be highly nonlinear; changes in the elements may not be related by simple proportionality. Furthermore, human value and judgment systems are integral elements of project problems. Therefore, the ability to make sound decisions is very important to the success of a project. In fact, Schuyler [21] makes it a skill that is certainly near the top of the list of project management skills, and notices that few of us have had formal training in decision making.

Multiple criteria decision-making (MCDM) approaches are major parts of decision theory and analysis. They seek to take explicit account of more than one criterion in supporting the decision process [3]. The aim of MCDM methods is to help decision-makers learn about the problems they face, to learn about their own and other parties' personal value systems, to learn about organizational values and objectives, and through exploring these in the context of the problem to guide them in identifying a preferred course of action [3]. In other words, MCDA is useful in circumstances which necessitate the consideration of different courses of action, which cannot be evaluated by the measurement of a simple, single dimension [3].

Hwang and Yoon [9] published a comprehensive survey of multiple attribute decision making methods and applications. Two types of the problems that are common in the project management that best fit MCDA models are evaluation problems and design problems. The evaluation problem is concerned with the

evaluation of, and possible choice between, discretely defined alternatives. The design problem is concerned with the identification of a preferred alternative from a potentially infinite set of alternatives implicitly defined by a set of constraints [3].

Belton [2] compared AHP and a simple multi-attribute value (MAV), as two of the multiple criteria approaches. She noticed that both approaches have been widely used in practice which can be considered as a measure of success. She also commented that the greatest weakness of the MAV approach is its failure to incorporate systematic checks on the consistency of judgments. She noticed that for large evaluations, the number of judgments required by the AHP can be somewhat of a burden.

A number of criticisms have been launched at AHP over the years. Watson and Freeling [24] said that in order to elicit the weights of the criteria by means of a ratio scale, the method asks decision-makers meaningless questions, for example: 'Which of these two criteria is more important for the goal? By how much?' Belton and Gear [4] and Dyer [5] pointed out that this method can suffer from rank reversal (an alternative chosen as the best over a set of X, is not chosen when some alternative, perhaps an unimportant one, is excluded from X). Belton and Gear [4] attacked the AHP on the grounds that it lacks a firm theoretical basis. They commented that the AHP is based upon a firm theoretical foundation and, as examples in the literature and the day-to-day operations of various governmental agencies, corporations and consulting firms illustrate, the AHP is a viable, usable decision-making tool.

The Analytic Hierarchy Process (AHP)

Developed by T.L. Saaty, the Analytic Hierarchy Process (AHP) is a multi criteria decision aiding method based on a solid axiomatic foundation. AHP is a systematic procedure for dealing with complex decision making problems in which many competing alternatives (projects, actions, scenarios) exist Forman and Selly[8], Saaty and Vargas [19], Saaty [17], Saaty[20], Vargas[25]. The alternatives are ranked using several quantitative and/or qualitative criteria, depending on how they contribute in achieving an overall goal

Table : Pairwise comparison matrix A of alternatives P~ with respect to criterion K

K	P1	P2	...	Pn
P1	1	a12	...	a1n
P2	1/a12	1	...	a2n
.
.
Pn	1/a1n	1/a2n	...	1

AHP is based on a hierarchical structuring of the elements that are involved in a decision problem. The hierarchy incorporates the knowledge, the experience and the intuition of the decision-maker for the specific problem. The simplest hierarchy consists of three levels. On the top of the hierarchy lies the decision's goal. On the second level lie the criteria by which the alternatives (third level) will be evaluated. In more complex situations, the main goal can be broken down into sub-goals or/and a criterion (or property) can be broken down into sub-criteria. People who are involved in the problem, their goals and their policies can also be used as additional levels.

The hierarchy evaluation is based on pairwise comparisons. The decision maker compares two alternatives A_i and A_j with respect to a criterion and assigns a numerical value to their relative weight. The result of the comparison is expressed in a fundamental scale of values ranging from 1 (A_i, A_j contribute equally to the objective) to 9 (the evidence favoring A_i over A_j is of the highest possible order of affirmation). Given that the n elements of a level are evaluated in pairs using an element of the immediately higher level, an $n \times n$ comparison matrix is obtained (Table). If the immediate higher level includes m criteria, m matrixes will be formed. In every comparison matrix all the main diagonal elements are equal to one ($a_{ij} = 1$) and two symmetrical elements are reciprocals of each other ($a_{ij} \times a_{ji} = 1$).

Since $n(n-1)/2$ pairwise comparisons are required to complete a comparison matrix, $mn(n-1)/2$ judgments must be made to complete the evaluation of the n elements of a level using as criterion the m elements of the immediately higher level. For large evaluations, the number of comparisons required by the AHP can be somewhat of a burden. For example, if 5 bids are

to be evaluated, in a model containing 20 criteria, at least $10 \times 20 = 200$ judgments must be made.

The decision-maker's judgments may not be consistent with one another. A comparison matrix is consistent if and only if $a_{ij} \times a_{jk} = a_{ik}$ for all i, j, k . AHP measures the in-consistency of judgments by calculating the consistency index CI of the matrix

$$CI = \frac{\lambda_{max} - n}{n - 1} \text{ -----eq. 1}$$

where λ_{max} is the principal Eigen value of the matrix.

The consistency index CI is in term divided by the *average random consistency index* RI to obtain the *consistency ratio* CR .

$$CR = \frac{CI}{RI} \text{ -----eq. 2}$$

The RI index is a constant value for an $n \times n$ matrix, which has resulted from a computer simulation of $n \times n$ matrices with random values from the 1-9 scale and for which $a_{ij} = 1/a_{ji}$. If CR is less than 5% for a 3x3 matrix, 9% for a 4x4 matrix, and 10% for larger matrices, then the matrix is consistent.

Once its values are defined, a comparison matrix is normalized and the local priority (the relative dominance) of the matrix elements with respect to the higher level criterion is calculated. The overall priority of the current level elements is calculated by adding the products of their local priorities by the priority of the corresponding criterion of the immediately higher level. Next, the overall priority of a current level element is used to calculate the local priorities of the immediately lower level which is use it as a criterion, and so on, till the lowest level of the hierarchy is reached. The priorities of the lowest level elements (alternatives) provide the relative contribution of the elements in achieving the overall goal.

Note that the AHP also allows group decision making. Each member of the group provides separately his own judgments according to his

experience, values and knowledge. If the group has achieved consensus on some judgment, only that judgment is registered. If during the process it is impossible to arrive at a consensus on a judgment, the group may use some voting technique, or may choose to take the "average" of the judgments, that is the geometric mean of the judgments. The group may decide to give all group members equal weight, or the group members could give them different weights that reflect their position in the project.

Saaty [15-20] developed the following steps for applying the AHP:

1. Define the problem and determine its goal.
2. Structure the hierarchy from the top (the objectives from a decision-maker's viewpoint) through the intermediate levels (criteria on which sub-sequent levels depend) to the lowest level which usually contains the list of alternatives.
3. Construct a set of pair-wise comparison matrices (size $n \times n$) for each of the lower levels with one matrix for each element in the level immediately above by using the relative scale measurement shown in Table 1. The pair-wise comparisons are done in terms of which element dominates the other.
4. There are $n(n-1)$ judgments required to develop the set of matrices in step 3. Reciprocals are automatically assigned in each pair-wise comparison.
5. Hierarchical synthesis is now used to weight the eigenvectors by the weights of the criteria and the sum is taken over all weighted eigenvector entries corresponding to those in the next lower level of the hierarchy.
6. Having made all the pair-wise comparisons, the consistency is determined by using the Eigen value, λ_{max} , to calculate the consistency index, CI as follows: $CI = (\lambda_{max} - n) / (n - 1)$, where n is the matrix size. Judgment consistency can be checked by taking the consistency ratio (CR) of CI with the appropriate value in Table 2. The CR is acceptable, if it does not exceed 0.10. If it is more, the judgment matrix is inconsistent. To obtain a consistent matrix, judgments should be reviewed and improved.
7. Steps 3-6 are performed for all levels in the hierarchy.

Table 1

Pair-wise comparison scale for AHP preferences [15 - 20]

Numerical rating	Verbal judgments of preferences
9	Extremely preferred
8	Very strongly to extremely
	Very strongly preferred
6	Strongly to very strongly
5	Strongly preferred
4	Moderately to strongly
3	Moderately preferred
2	Equally to moderately
1	Equally preferred

Table 2

Average random consistency (RI) [15 - 20]

Size of matrix	1	2	3	4	5	6	7	8	9	10
Random consistency	0	0	0.58	0.9	1.12	1.24	1.32	1.41	1.45	1.49

Group decision making

The AHP allows group decision making, where group members can use their experience, values and knowledge to break down a problem into a hierarchy and solve it by the AHP steps. Brainstorming and sharing ideas and insights (inherent in the use of Expert Choice in a group setting) often leads to a more complete representation and understanding of the issues. The following suggestions and recommendations are suggested in the Expert Choice software manual.

1. Group decisions involving participants with common interests are typical of many organizational decisions. Even if we assume a group with common interests, individual group members will each have their own motivations and, hence, will be in conflict on certain issues. Nevertheless, since the group members are 'supposed' to be striving for the same goal and have more in common than in conflict, it is usually best to work as a group and attempt to achieve consensus. This mode maximizes communication as well as each group member's stake in the decision.
2. An interesting aspect of using Expert Choice is that it minimizes the difficult problem of 'group-think' or dominance by a strong member of the group. This occurs because attention is focused on a specific aspect of the problem as judgments are being made, eliminating drift from topic to topic as so often happens in group discussions. As a result, a person who may be shy and hesitant to speak up when a group's discussion drifts from topic to topic will feel more comfortable in speaking up when the discussion is organized and attention turns to his area of expertise. Since Expert Choice reduces the influences of group-think and dominance, other decision processes such as the well known Delphi technique may no longer be attractive. The Delphi technique was designed to alleviate groupthink and dominance problems. However, it also inhibits communication between members of the group. If desired, Expert Choice could be used within the

Delphi context.

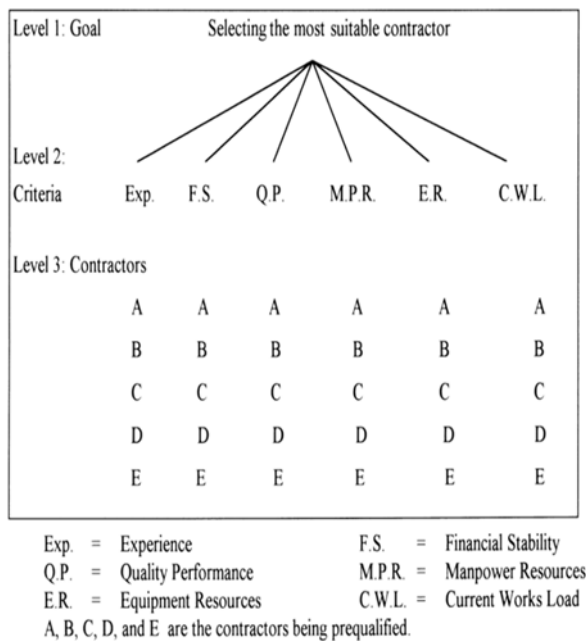
3. When Expert Choice is used in a group session, the group can be shown a hierarchy that has been prepared in advance. They can modify it to suit their understanding of the problem. The group defines the issues to be examined and alters the prepared hierarchy or constructs a new hierarchy to cover all the important issues. A group with widely varying perspectives can feel comfortable with a complex issue, when the issue is broken down into different levels. Each member can present his own concerns and definitions. Then, the group can cooperate in identifying the overall structure of the issue. In this way, agreement can be reached on the higher-order and lower-order objectives of the problem by including all the concerns that members have expressed. The group would then provide the judgments. If the group has achieved consensus on some judgment, input only that judgment. If during the process it is impossible to arrive at a consensus on a judgment, the group may use some voting technique, or may choose to take the 'average' of the judgments. The group may decide to give all group members equal weight, or the group members could give them different weights that reflect their position in the project. All calculations are done automatically on the computer screen.
4. The Group Meeting: While Expert Choice is an ideal tool for generating group decisions through a cohesive, rigorous process, the software does not replace the components necessary for good group facilitation. There are a number of different approaches to group decision-making, some better than others. Above all, it is important to have a meeting in which everyone is engaged, and there is buy-in and consensus with the result.

A simplified project example of contractor pre-qualification will be demonstrated here for illustration purposes. To simplify calculations, the factors that will be used in the project

example for prequalification are experience, financial stability, quality performance, manpower resources, equipment resources, and current workload. Other criteria can be added if necessary, together with a suggestion that a computer be used to simplify calculations.

Table 1 Pair wise comparison scale for AHP preference [11-14] given by saaty for verbal judgment of preferences with some numerical ratings.

By following the AHP procedure, the hierarchy of the problem can be developed as shown in box below. For step 3, the decision-makers have to indicate preferences or priority for each decision alternative in terms of how it contributes to each criterion.



Expected Outcomes

Project management involves complex decision making situations that require discerning abilities and methods to make sound decisions. It has presented the AHP as a decision-making method that allows the consideration of multiple criteria. An example of contractors/ consultants prequalification can be created to demonstrate AHP application in project management. Contractors and or Consultants prequalification involve criteria and priorities that are determined by owner requirements and preferences as well as the characteristics of the individual executing agency. AHP allows group decision-making.

Conclusion

The exercise of prequalification on International bidding of major projects is done. The above process will be very much helpful for taking the decision on multi criterion basis. The method can be implemented on computer for getting fast decision. However the method can be used by financial Agencies to check proposals submitted by borrowing agencies to finalize the contractors and or consultants for prequalification.

References

- [1] Al- Subhi Al-Harbi. Application of the AHP in project management in Saudi Arabia. King Fahd University of Petroleum and Minerals, KFUPM, Dhahran, Saudi Arabia, International Journal of Project Management 2001: 19-27.
- [2] Belton V. A comparison of the analytic hierarchy process and a simple multi-attribute value function. European Journal of Operational Research 1986;26:7±21.
- [3] Belton V. Multiple criteria decision analysis is practically the only way to choose. In: Hendry LC, Eglese RW, editors. Operational research tutorial papers. 1990, pp. 53±102
- [4] Belton V, Gear T. On a shortcoming of Saaty's method of ana-lytical hierarchy. Omega 1983;11(3):228±30.
- [5] Dyer JS. Remarks on the analytical hierarchy process. Manage-ment Science 1990;3:249±58
- [6] Doraid Dalalah. Application of the Analytic hierarchy Process (AHP) in Multi Criteria Analysis of the Selection of Cranes. Industrial Engineering Department, Faculty of Engineering, Jordan University of Science and Technology, Irbid. 2010,pp.567-578.
- [7] Fatemeh Torfi. Selection of Project Managers in Construction Firm Using Analytic Hierarchy Process (AHP) and Fuzzy Topsis. Journal of Construction in Developing contries. 2011,pp. 69-89.
- [8] Forman E.H. and Selly M.A. Decision by objectives. World Scientific Publications. 2002

- [9] Hwang CL, Yoon K. Multiple attribute decision making: Methods and applications: A-State-of-the-Art Survey. Berlin: Springer-Verlag, 1981.
- [10] K.P. Anagnostopoulos. An AHP Model for Construction Prequalification Democritus University of Thrace, Greece. Operational Research. An International Journal.2006, Vol.6,No.3 pp.333-346.
- [11] Kumaraswamy M.M. Contractor evaluation and selection: a Hong Kong perspective. Building and Environment,1996; 31, No. 3,273-282
- [12] Mohammad A. Mustafa.Project Risk Assessment Using the Analytic Hierarchy Process. IEEE Transactions on Engineering Mangement.1991Vol. 38 No.1, pp. 46-52.
- [13] Moore MJ. Selecting a contractor for fast-track projects: Part I, principles of contractor evaluation. Plant Engineering 1985;39:74±5
- [14] Palaneeswaran E. and Kumaraswamy M.M.: Recent advances and proposed improvements in contractor prequalification methodologies. Building and Environment 2001: 36, 73-87.
- [15] Saaty TL. The analytic hierarchy process. New York: McGraw-Hill, 1980.
- [16] Saaty TL. Decision making for leaders. Belmont, California: Life Time Learning Publications, 1985.
- [17] Saaty TL. How to make a decision: the analytic hierarchy process. European Journal of Operational Research, North-Holland 1990;48:9±26.
- [18] Saaty TL, Kearns KP . Analytical planning: the organization of systems. The analytic hierarchy process series 1991;vol. 4RWS PublicationsPittsburgh, USA.
- [19] Saaty T.L. and Vargas L.G. Decision making with the Analytic Hierarchy Process. RWS Publications.1994
- [20] Saaty T.L. (1995). Decision making for leaders, 3rd Edition. RWS Publications.
- [21] Schuyler JR. Decision analysis in projects. Upper Darby, PA, USA: Project Management Institute, 1996.
- [22] Topcu Y.I. . A decision model proposal for construction contractor selection in Turkey. Building and Environment, 2004; 39, 469-81
- [23] Tversky A. Elimination by aspects: a theory of choice. Psychological Review 1972;79(4):281±99
- [24] Watson SR, Freeling ANS. Assessing attribute weights. Omega 1982;10(6):582±3.
- [25] Vargas L.G. An overview of the Analytic Hierarchy Process and its applications. European Journal of Operational Research,1990; 48(1), 2-8.

HEAT TRANSFER ENHANCEMENT BY SWIRL FLOW DEVICES

Tarique Anwar Qureshi¹, Anil Singh Yadav²

¹Assistant Professor, Technocrats Institute of Technology and Science (TITS), Bhopal (M.P)

²Professor, Lakshmi Narain College of Technology Excellence (LNCTE), Bhopal (M.P)

E-mail-tariqanwar2001@gmail.com¹, anilsinghyadav@gmail.com²

Abstract

Heat transfer augmentation techniques refer to different methods used to increase rate of heat transfer without affecting much the overall performance of the system. Heat transfer augmentation techniques (passive, active or a combination of passive and active methods) are commonly used in areas such as process industries, heating and cooling in evaporators, thermal power plants, air-conditioning equipment, refrigerators, radiators for space vehicles, automobiles, etc. Passive techniques, where inserts are used in the flow passage to augment the heat transfer rate, are advantageous compared with active techniques, because the insert manufacturing process is simple and these techniques can be easily employed in an existing heat exchanger. Twisted-tape is one of the most important members of enhancement techniques, which employed extensively in heat exchangers. Twisted tapes are the metallic strips twisted with some suitable techniques with desired shape and dimension, inserted in the flow. This paper demonstrates the various studies on twisted tapes inserts.

Key words: Heat transfer augmentation, Thermohydraulic performance, Twisted tape, Wire coil

I. INTRODUCTION

The process of improving the performance of a heat transfer system or increase in heat transfer coefficient is referred to as heat transfer augmentation or enhancement. This leads to reduce size and cost of heat exchanger. An increase in heat transfer coefficient generally leads to additional advantage of reducing temperature driving force, which increases second law efficiency and decreases entropy generation. General techniques for enhancing heat transfer can be divided in three categories. One is passive method such as twisted tapes, helical screw tape inserts, rough surfaces, extended surfaces, additives for liquid and gases. The second is active method, which requires extra external power, for example mechanical aids, surface fluid vibration, use of electrostatic fields. Passive methods are found more inexpensive as compared to other group.

Twisted tape is one of the most important members useful in laminar flow from this group.

Twisted Tape Twisted tape inserts increases the heat transfer coefficients with relatively small increase in the pressure drop.

They are known to be one of the earliest swirl flow devices employed in the single phase heat transfer processes. Because of the design and application convenience they have been widely used over decades to generate the swirl flow in the fluid. Size of the new heat exchanger can be reduced significantly by using twisted tapes in the new heat exchanger for a specified heat load. Thus it provides an economic advantage over the fixed cost of the equipment. Twisted tapes can be also used for retrofitting purpose. It can increase the heat duties of the existing shell and tube heat exchangers. Twisted tapes with multitube bundles are easy to fit and remove, thus enables tube side cleaning in fouling situations. Inserts such as twisted tape, wire coils, ribs and dimples mainly obstruct the flow and separate the primary flow from the secondary flows. This causes the enhancement of the heat transfer in the tube flow. Inserts reduce the

effective flow area thereby increasing the flow velocity. This also leads to increase in the pressure drop and in some cases causes significant secondary flow. Secondary flow creates swirl and the mixing of the fluid elements and hence enhances the temperature gradient, which ultimately leads to a high heat transfer coefficient.

In general, swirl flow generators are placed in the flow passage to augment the heat transfer rate, and this reduces the hydraulic diameter of the flow passage. Heat transfer enhancement in a tube flow by inserts such as twisted tapes, screw tape is mainly due to flow blockage, partitioning of the flow and secondary flow. Flow blockage increases the pressure drop and leads to increased viscous effects because of a reduced free flow area. Blockage also increases the flow velocity and in some situations leads to a significant secondary flow. Secondary flow further provides a better thermal contact between the surface and the fluid because secondary flow creates swirl and the resulting mixing of fluid improves the temperature gradient, which ultimately leads to a high heat transfer coefficient. Fig. 1 shows a typical configuration of twisted tape which is used commonly.

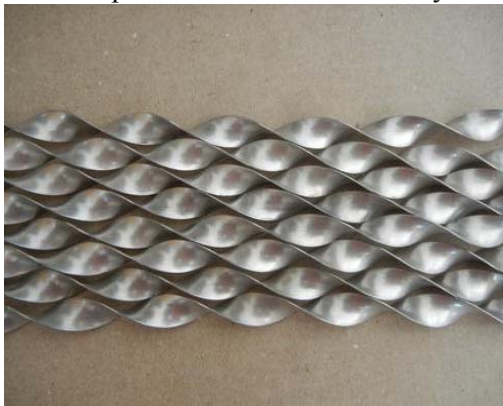


Fig. 1 : Twisted Tape

II. REVIEW OF LITERATURE

Shaha and Dutta [11] reported experimental data on twisted tape generated laminar swirl flow friction factor and Nussult number for a large Prandle number ($205 < Pr < 518$) and observed that on the basis of constant pumping power short length twisted tape is good choice because in this case swirl generated by the twisted tape decays slowly down streams which increases the

heat transfer coefficient with minimum pressure drop as compared to full length twisted tape. Fig. 2 shows the different types of twisted taps. Manglik and Bergles [12] considered twisted tape with twist ratio (3, 4.5 and 6.0) using water ($3.5 < Pr < 6.5$) and proposed correlation for Nussult number and friction factor and reported physical description and enhancement mechanism. Loknath [13] reported experimental data on water ($240 < Re < 2300$, $2.6 < Pr < 5.6$) of laminar flow through horizontal tube under uniform heat flux condition and fitted with half-length twisted tape. He found that on the basis of unit pumping power and unit pressure drop half-length twisted tape is more efficient than full length tape. Shaha and Chakraborty [14] found that laminar flow of water ($145 < Re < 1480$, $4.5 < Pr < 5.5$, tape ratio $1.92 < \gamma < 5.0$) and pressure drop characteristics in a circular tube fitted with regularly spaced, there is drastic reduction in pressure drop corresponding reduction in heat transfer. Thus it appears that on basis of constant pumping power a large number of turn may yield improved thermo hydraulic performance compared with single turn on twisted tape. Royds [15] reported that A tube inserted with twisted tape performs better than plain tube and twisted tape with tight twist ratio provides better heat transfer at a cost of increase in pressure drop for low Prandle number fluid. This is due to the small thickness of thermal boundary layer for low Prandle number fluid and tighter twist ratio disturb entire thermal boundary layer thereby increasing heat transfer with increase in pressure drop. Date [16] reported that friction and Nu for water flow in tube containing twisted tape deviate 30 percent than experiment with plain tube. Klaczak [17] found usefulness of short length twisted tape with water ($1300 < Re < 8000$) than full length twisted tape. Al-fahed et al. [18] found that there is an optimum tape width depending upon twist ratio and Re for best thermodynamic characteristics for full length tape with water. Manglik and Bergles [19] developed correlation for both lamina and turbulent flow ($3.5 < Pr < 6.5$) with tape but shows that correlation for laminar turbulent transition need to be developed with water. For more details readers can referee Waghole et al. [20].

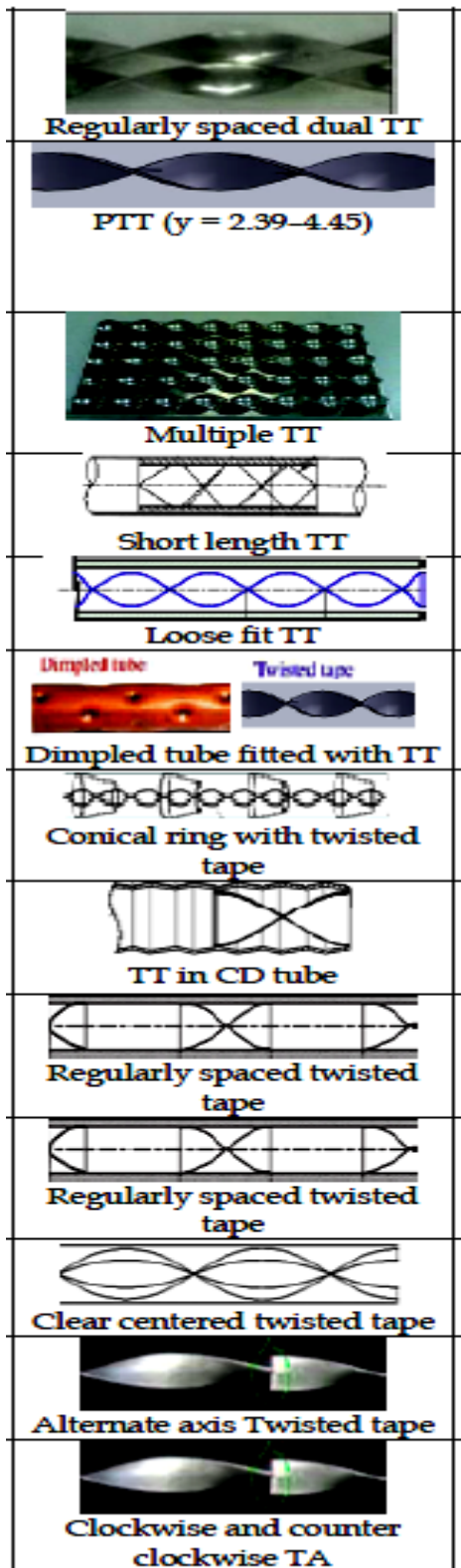


Fig. 2 : Different Types of Twisted Tap.

Several investigations have been carried out to study the effect of turbulators (turbulent promoters) with different geometries on thermal behaviors in the heat exchanger, for example

twisted-tapes [21,22], wirecoils [23,24], dimpled or grooved tubes [25,26], wingle/fin [27,28], and combined turbulators. However, twisted tapes as one of passive turbulators have been applied extensively to enhance convection heat transfer in heat exchanger systems due to the need for finding the way to reduce the size and cost of those systems. For decades, the heat transfer enhancement by twisted-tape insert has been widely investigated both experimentally and numerically. Krishna et al. [29] experimentally investigated the heat transfer characteristics in a circular tube fitted with straight full twist insert with different spacer distances. Influence of the tube equipped with the short-length twisted tape on Nu , f and thermal performance characteristics for several tape-length ratios was examined by Eiamsa-ard et al. [30]. The effect of twisted tape consisting wire-nails and plain twisted tapes with three different twist ratios fitted in a heat exchanger pipe using water as the test fluid on thermal characteristics was studied experimentally by Murugesan et al. [31]. Liao and Xin [32] reported the heat transfer behaviors in a tube with three-dimensional internal extended surfaces and twisted-tape inserts with various working fluids. Chiu and Jang [33] presented the experimental and numerical analyses on thermal-hydraulic characteristics of air flow inside a circular tube with 5 different tube inserts; longitudinal strip inserts both with/without holes and twisted-tape inserts with three different twist angles for inlet velocity ranging from 3 to 18 $m \cdot s^{-1}$. Eiamsa-ard and Promvong [34] conducted an experimental study on turbulent flow and heat transfer characteristics in a tube equipped with two types of twisted tapes: (1) typical twisted tapes and (2) alternate clockwise and counterclockwise twisted-tapes. Nine different clockwise and counterclockwise twisted-tapes were tested in that work and included the tapes with three twist-ratios and three twist-angles. The experiments were performed for Reynolds number of 3000 to 27000 using water as working fluid. The twin and triple twisted tapes used to generate twin and triple swirl flows in a circular tube were reported by Chang et al. [35].

III. CONCLUSION

Heat exchanger as equipment to facilitate the convective heat transfer of fluid inside tubes is frequently utilized in many industrial applications, such as chemical engineering process, heat recovery, air conditioning and refrigeration systems, power plant and radiators for automobiles. In general, heat transfer enhancement in heat exchangers can be divided into two methods. One is the active method requiring extra external power sources such as fluid vibration, injection and suction of the fluid, jet impingement and electrostatic fields. The other is the passive method that requires no other power source. The devices in this category are surface coating, rough surfaces, turbulent/swirl flow devices, extended surfaces etc.

A twisted tape insert mixes the bulk flow well and therefore performs better in laminar flow, because in laminar flow the thermal resistant is not limited to a thin region. The result also shows twisted tape insert is more effective, if no pressure drop penalty is considered. Twisted tape in turbulent flow is effective up to a certain Reynolds number range. It is also concluded that twisted tape insert is not effective in turbulent flow, because it blocks the flow and therefore pressure drop increases. Hence the thermohydraulic performance of a twisted tape is not good in turbulent flow. These conclusions are very useful for the application of heat transfer enhancement in heat exchanger networks.

A twisted tape mixes with bulk flow and are better for laminar flow than any other inserts. However twisted tape inserts performance also depends fluid properties such as Prandtl number. If the Prandtl number is high ($Pr > 30$) twisted tape will not provide good thermo hydrodynamic performance compared with other inserts such as wire coil inserts.

This helical screw tape can help to promote higher heat transfer exchange rate than the use of twisted-tape because of shorter pitch length which leads to stronger swirling flow and longer residence time in the tube. Because of lower pressure drop and ease of manufacturing, the twisted-tape is, in general, more popular than the helical screw-tape having a higher heat transfer rate at the same mass flow rate. However, at low

values of Reynolds number the pressure drops for using both tapes are not much different. Heat transfer of square tubes was found considerably higher than the circular tube. This is mainly because of square duct has high surface to volume ratio.

The combined use of full-length twisted-tape and transverse ribs enhances the thermohydraulic performance of the square and rectangular ducts compared to the use of only twisted-tape or only transverse ribs for laminar flow. The short-length twisted tape in square and rectangular ducts performs worse than the full-length twisted tape. However, regularly spaced twisted-tapes perform significantly better than the full-length twisted tapes.

This review paper discusses the considerable experimental work which has been done on heat transfer augmentation using twisted tape inserts. This paper reviews the investigation carried out by various researches in order to enhance the heat transfer, nusselt number, and friction factor by the use of twisted tapes inserts of different shapes, sizes and orientation.

REFERENCES

- [1] S. Eiamsa-ard and P. Promvong, Heat transfer characteristics in a tube fitted with helical screw-tape with/without core rod inserts, *International Communications in Heat and Mass Transfer*, vol. 34, no. 2, pp. 176–185, 2007.
- [2] H. A. Mohammed, S. Tabatabaeikia, and K. M. Munisamy, Heat transfer enhancement using nano fluids in a circular tube fitted with inserts, *Journal of Computational and Theoretical Nano science*, vol. 11, no. 3, pp. 655–666, 2014.
- [3] P. Promvong, Thermal performance in circular tube fitted with coiled square wires, *Energy Conversion and Management*, vol. 49, no. 5, pp. 980–987, 2008.
- [4] P. Promvong, Thermal augmentation in circular tube with twisted tape and wire coil turbulators, *Energy Conversion and Management*, vol. 49, no. 11, pp. 2949–2955, 2008.
- [5] P. Promvong, Thermal enhancement in a round tube with snail entry and coiled-wire inserts, *International Communications in Heat and Mass Transfer*, vol. 35, no. 5, pp. 623–629, 2008.

- [6] P. Promvonge and C.Thianpong, Thermal performance assessment of turbulent channel flows over different shaped ribs, *International Communications in Heat and Mass Transfer*, vol. 35, no. 10, pp. 1327–1334, 2008.
- [7] C. Thianpong, T. Chompookham, S. Skullong, and P. Promvonge, Thermal characterization of turbulent flow in a channel with isosceles triangular ribs, *International Communications in Heat and Mass Transfer*, vol. 36, no. 7, pp. 712–717, 2009.
- [8] S. Sripattanapipat and P. Promvonge, Numerical analysis of laminar heat transfer in a channel with diamond-shaped baffles, *International Communications in Heat and Mass Transfer*, vol. 36, no. 1, pp. 32–38, 2009.
- [9] P. Promvonge, T. Chompookham, S. Kwankaomeng, and C.Thianpong, Enhanced heat transfer in a triangular ribbed channel with longitudinal vortex generators, *Energy Conversion and Management*, vol. 51, no. 6, pp. 1242–1249, 2010.
- [10] T. Chompookham, C. Thianpong, S. Kwankaomeng, and P. Promvonge, Heat transfer augmentation in a wedge-ribbed channel using winglet vortex generators, *International Communications in Heat and Mass Transfer*, vol. 37, no. 2, pp. 163– 169, 2010.
- [11] Shah S.k. and Dutta A, Friction and Heat transfer characteristics of laminar swirl flow through a circular tube fitted with regularly spaced tube element, *International Journal of heat and mass transfer*, 2001, 44, 4211-4223.
- [12] Manglik R.M. and Bergle A. E. Heat transfer and pressure drop relation for twisted tape inserts in isothermal tube, *Journal of heat transfer*, 1993, 116,881-889.
- [13] Loknath. An experimental study on performance plate heat exchanger and augmented shell and tube heat exchanger, ASME, Heat and mass transfer conference, 2002, pp863-868.
- [14] Shaha and chakraborty. Heat and pressure drop characteristics of laminar flow in circular tube fitted with regularly spaced twisted tape element with multiple twist, ISHMT, Heat and mass transfer conference, 1997, pp 313-318.
- [15] Royds. Heat transfer by radiation, convection and conduction, constable and camp ltd, 1921, pp 190-201.
- [16] Date A.W. Flow in tube containing twisted tape Heat and vent Engr, *journal of environmental science*, 1973, 47, pp 240-24.
- [17] Klaczak A. Heat and pressure drop in tube with short tabulator, *Warme and stoffebetrtragung*, 1996, 31, pp 399-401
- [18] Al-fahed et al. Effect of tube tape clearance for heat transfer for fully developed turbulent flow in horizontal isothermal tube, *International journal of heat and fluid flow*, 1996, 17, pp173-178.
- [19] Manglik R. K. and Bergle A.E. Heat transfer and pressure drop correlation for twisted tape inserts I isothermal tube part II, ASME, *Journal of heat transfer*, 1993, 115, pp 890-896.
- [20] D.R.Waghole, R.M.Warkhedkar, V.S. kulkarni, N. K. Sane. A Review on Heat Transfer Augmentation using Twisted Tape inserts in Absorber/Receiver of PTC. IOSR *Journal of Mechanical and Civil Engineering (IOSR-JMCE) Second National Conference on Recent Developments in Mechanical Engineering* PP. 33-36.
- [21] S. Eiamsa-ard, C. Thianpong, P. Promvonge, Experimental investigation of heat transfer and flow friction in a circular tube fitted with regularly spaced twisted tape elements, *Int. Commun. Heat Mass Transfer* 33 (10) (2006) 1225–1233
- [22] S.W. Chang, T.L. Yang, J.S. Liou, Heat transfer and pressure drop in tube with broken twisted tape insert, *Exp. Thermal Fluid Sci.* 32 (2) (2007) 489–501.
- [23] P. Promvonge, Thermal performance in circular tube fitted with coiled square wires, *Energy Convers. Manage.* 49 (5) (2008) 980–987.
- [24] S. Gunes, V. Ozceyhan, O. Buyukalaca, Heat transfer enhancement in a tube with equilateral triangle cross sectioned coiled wire inserts, *Exp. Thermal Fluid Sci.* 34 (6) (2010) 684–691.
- [25] Y. Wang, Y.L. He, Y.G. Lei, J. Zhang, Heat transfer and hydrodynamics analysis of a novel dimpled tube, *Exp. Thermal Fluid Sci.* 34 (8) (2010) 1273–1281.
- [26] K. Bilen, M. Cetin, H. Gul, T. Balta, The investigation of groove geometry effect on

- heat transfer for internally grooved tubes, *Appl. Therm. Eng.* 29 (4) (2009) 753–761.
- [27]S. Skullong, P. Promvonge, Experimental Investigation on Turbulent Convection in Solar Air Heater Channel Fitted with Delta Winglet Vortex Generator, *Chin. J. Chem. Eng.* 22 (1) (2014) 1–10.
- [28]P. Promvonge, S. Skullong, S. Kwankaomeng, C. Thiangpong, Heat transfer in square duct fitted diagonally with angle-finned tape—Part 1: Experimental study, *Int. Commun. Heat Mass Transfer* 39 (5) (2012) 617–624.
- [29]S.R. Krishna, G. Pathipaka, P. Sivashanmugam, Heat transfer and pressure drop studies in a circular tube fitted with straight full twist, *Exp. Thermal Fluid Sci.* 33 (3) (2009) 431–438.
- [30]S. Eiamsa-ard, C. Thianpong, P. Eiamsa-ard, P. Promvonge, Convective heat transfer in a circular tube with short-length twisted tape insert, *Int. Commun. Heat Mass Transfer* 36 (3) (2009) 365–371.
- [31]P. Murugesan, K. Mayilsamy, S. Suresh, Heat transfer and friction factor studies in a circular tube fitted with twisted tape consisting of wire-nails, *Chin. J. Chem. Eng.* 18 (6) (2010) 1038–1042.
- [32]Q. Liao, M.D. Xin, Augmentation of convective heat transfer inside tubes with threedimensional internal extended surfaces and twisted-tape inserts, *Chem. Eng. J.* 78 (2–3) (2000) 95–105.
- [33]Y.W. Chiu, J.Y. Jang, 3D numerical and experimental analysis for thermal–hydraulic characteristics of air flow inside a circular tube with different tube inserts, *Appl. Therm. Eng.* 29 (2–3) (2009) 250–258.
- [34]S. Eiamsa-ard, P. Promvonge, Performance assessment in a heat exchanger tube with alternate clockwise and counter-clockwise twisted-tape inserts, *Int. J. Heat Mass Transf.* 53 (7–8) (2010) 1364–1372.
- [35]S.W. Chang, K.W. Yu, M.H. Lu, Heat transfer in tubes fitted with single, twin and triple twisted tapes, *Exp. Heat Transfer* 18 (2005) 279–294.

ANALYSIS OF LOOSE VIRTUAL CLUSTERING BASED ROUTING ALGORITHM FOR POWER HETEROGENEOUS MANETS

Vinod Mahor¹, Sadhana Bijrothiya²

¹Assistant Professor, Department of Computer Science & Engineering,
Radharaman Institute Technology & Science, Bhopal (M.P)

²Assistant Professor, Department of Computer Science & Engineering,
IPS-CTM, Gwalior (M.P)

Email:vinodengg.mt@rediffmail.com¹. sadhanaengg@gmail.com²

Abstract

A mobile ad hoc network (MANET) is a multi-hop wireless network formed by a group of mobile nodes that have wireless capabilities and are in proximity of each other. As nodes are mobile in a MANET, links are created and destroyed in an unpredictable way, which makes quite challenging the determination of routes between a pair of nodes that want to communicate with each other. Power heterogeneity is common in mobile ad hoc networks (MANETs). With high-power nodes, MANETs can improve network scalability, connectivity and broadcasting robustness. However, the throughput of power heterogeneous MANETs could be severely impacted by high-power nodes. MANETs are a kind of wireless ad hoc networks that usually has a routable networking environment on top of a link layer Ad hoc network. To address this issue, we present LRP, a loose virtual clustering based routing protocol for Power Heterogeneous MANETs. In particular, to explore the advantages of high-power nodes, we develop a loose virtual clustering algorithm to construct a hierarchical network and eliminate unidirectional links. To reduce the interference raised by high-power nodes, we develop routing algorithms to avoid packet forwarding via high-power nodes. Via the combination of analytical modelling, simulations, and real-world experiments, we demonstrate the effectiveness of LRP on improving the performance of power heterogeneous MANETs.

Index Terms: Clustering, Routing Algorithm, Power Heterogeneous, MANETs.

I. INTRODUCTION

Mobile Ad hoc Network (MANET) is a collection of mobile nodes equipped with both a wireless transmitter and a receiver that communicate with each other via bidirectional wireless links either directly or indirectly. Industrial remote access and control via wireless networks are becoming more and more popular these days [3]. One of the major advantages of wireless networks is its ability to allow data communication between different parties and still maintain their mobility. However, this communication is limited to the range of transmitters. This means that two nodes cannot communicate with each other when the distance between the two nodes is beyond the communication range of their own. MANET

solves this problem by allowing intermediate par-ties to relay data transmissions. This is achieved by dividing MANET into two types of networks, namely, single-hop and multihop. In a single-hop network, all nodes within the same radio range communicate directly with each other. On the other hand, in a multihop network, nodes rely on other intermediate nodes to transmit if the destination node is out of their radio range. In contrary to the traditional wireless network, MANET has a decentralized network infrastructure. MANET does not require a fixed infrastructure; thus, all nodes are free to move randomly MANET is capable of creating self-configuring and self-maintaining network without the help of a centralized infrastructure, which is often infeasible in critical mission

applications like military conflict or emergency recovery.

Minimal configuration and quick deployment make MANET ready to be used in emergency circumstances where an infrastructure is unavailable or unfeasible to install in scenarios like natural or human-induced disasters, military conflicts, and medical emergency situations. Owing to these unique characteristics, MANET is becoming more and more widely implemented in the industry. However, considering the fact that MANET is popular among critical mission applications, network security is of vital importance. Unfortunately, the open medium and remote distribution of MANET make it vulnerable to various types of attacks. For example, due to the nodes' lack of physical protection, malicious attackers can easily capture and compromise nodes to achieve attacks. In particular, considering the fact that most routing protocols in MANETs assume that every node in the network behaves cooperatively with other nodes and presumably not malicious, attackers can easily compromise MANETs by inserting malicious or non-cooperative nodes into the network. Furthermore, because of MANET's distributed architecture and changing topology, a traditional centralized monitoring technique is no longer feasible in MANETs. In such case, it is crucial to develop an intrusion-detection system (IDS). In present days, mobile communication has increased in usage and popularity. Tasks earlier handled by wired communication can now be performed using wireless devices offering different styles of technologies (such as IEEE 802.11, IEEE 802.16, Bluetooth and so on) that also provide for the user the advantage of the mobility. For some tasks, such as the ones involved during emergency network scenarios, the use of wireless devices is mandatory. Some relevant scenarios include coalition military operation, disaster relief efforts, and on-the-fly team formation for a common mission, such as search and rescue. The problem is how to improve the routing performance of a power heterogeneous MANET by efficiently exploiting the advantages and avoiding the disadvantages of high-power nodes, which is the focus of our paper. In this paper, we develop a Loose Virtual Clustering (LVC) based routing protocol for power heterogeneous MANETs, named LRPB (LVC-based Routing for Power Heterogeneous). Our

protocol is compatible with the IEEE 802.11 DCF protocol. It does not rely on geographic information [8], or multi-radios multi-channel [9], and can be deployed on general mobile devices, including laptop, PDAs, and others. LRPB takes the double-edged nature of high-power nodes into account. To exploit the benefit of high-power nodes, a novel hierarchical structure is maintained in LVC, where the unidirectional links are detected effectively. Clustering is a known scheme to improve the performance of the networks [2]. However, in the existing clustering schemes, each node in the network should play a certain role (e.g., cluster head, member, or gateway). We define this as a strong-coupling cluster. In a strong-coupling cluster, the cost of constructing and maintaining a cluster may increase significantly and affect the network performance. In our clustering, a loose coupling relationship is established between nodes. Based on the LVC,

II. RELATED WORK

Numerous routing protocols have been developed in the wireless networking community to target various scenarios, and many research efforts have been paid to study the taxonomy of the ad hoc routing protocols, and conducted the survey of the representative protocols in different categories [5]–[7]. For example, Boukerche *et al.* [6] provided the comprehensive summary of the routing protocols for MANETs. Unfortunately, most of the existing protocols are limited to homogenous networks and perform ineffectively in power heterogeneous networks. There are some routing protocols for heterogeneous MANETs. For example, MC (Multiclass) [9] is a position aided routing protocol for power heterogeneous MANETs. The idea of MC is to divide the entire routing area into cells, and select a high-power node in each cell as the backbone node. Then, a new MAC protocol, denoted as hybrid MAC (HMAC), is designed to cooperate with the routing layer. Based on the cell structure and HMAC, MC achieves better performance. However, the fixed cell makes MC work well only in a network with high density of high-power nodes. Work in presented a cross-layer approach, which extends the MAC and network layers to minimize the problems caused by the link asymmetry and exploits the advantages of heterogeneous MANETs simultaneously. Work

in [2] proposed a cross-layer designed Device-Energy-Load Aware Relaying framework, denoted as DELAR, to achieve energy conservation from multiple facets, including power-aware routing, transmission scheduling, and power control. DELAR mainly focuses on addressing the issue of energy conservation in heterogeneous MANETs. Work in developed a cross-layer approach to address several challenging problems raised by link asymmetry in power heterogeneous MANETs. In particular, an algorithm at the network layer was proposed to establish reverse paths for unidirectional links and share the topological information with the MAC layer. In the link layer, a new MAC protocol was presented based on the IEEE 802.11 to address the heterogeneous hidden exposed terminal problems in power heterogeneous MANETs. Different from the existing routing on power heterogeneous MANETs, our proposed approach does not rely on the geographic information or multi-radio multi-channel, and can be deployed on general 802.11 based mobile devices.

in cluster. In the near future, computing environment can be expected based on the recent progresses and advances in the computing and communication technologies. Next generation of mobile communications will include both prestigious infrastructure wireless networks and novel infrastructure less mobile ad hoc networks (MANETs). Power heterogeneity is common in mobile ad hoc networks (MANETs). With high power nodes, MANETs can improve network scalability, connectivity and broadcasting robustness. However, the throughput of power heterogeneous MANETs could be severely impacted by high-power nodes. In 802.11 based power heterogeneous MANETs, mobile nodes have different transmission power, and power heterogeneity becomes a double-edged sword. On one hand, the benefits of high-power nodes are the expansion of network coverage area and the reduction in the transmission delay. The proposed system considers the power aware routing protocol for a MANET formed of heterogeneous nodes. The proposed approach takes into consideration the battery status of nodes when building the routing table. The developed routing scheme is to optimize packet forwarding by avoiding data packet forwarding through high-power nodes. Due to high mobility of nodes in mobile ad hoc networks (MANETs), there exist frequent link breakages which lead to frequent path failures and route discoveries. A neighbour coverage-based probabilistic rebroadcast protocol is used for reducing routing overhead in MANETs. This approach combines the advantages of the neighbour coverage knowledge and the probabilistic mechanism, which can significantly decrease the number of retransmissions so as to reduce the routing overhead, and can also improve the routing performance. The ability of lower power nodes to receive transmissions from higher power nodes but not vice versa. This not only poses challenges at the routing layer, but also results in an increased number of collisions at the MAC layer due to high nodes initiating transmissions while low power communications are in progress. Previously proposed routing protocols for handling unidirectional links largely ignore MAC layer dependencies [3]. The capacity scaling laws of mobile ad-hoc networks comprising heterogeneous nodes and spatial in homogeneities [4]. Most of previous work relies on the assumption that nodes are identical and

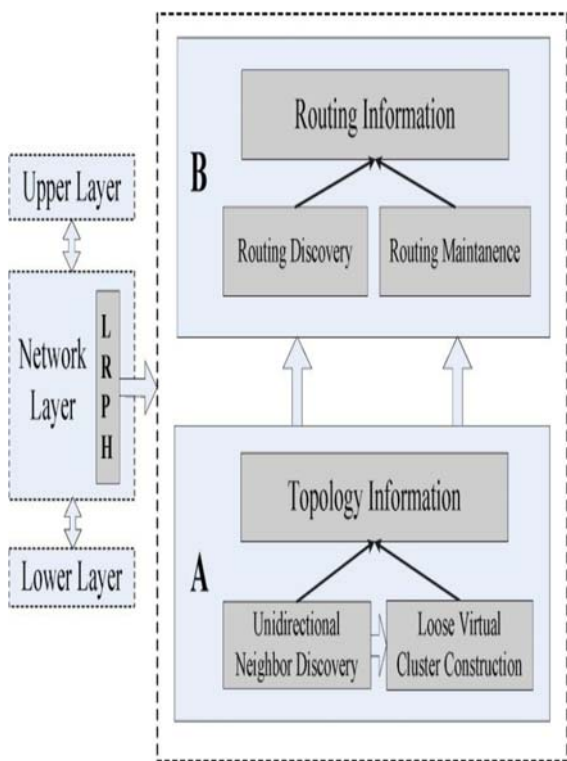
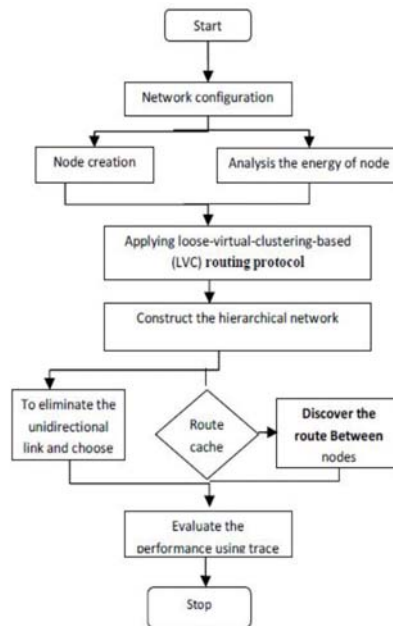


Figure.1 Overview of the LRPH

Our proposal considers both the advantage and disadvantage of high-power nodes. In addition, some realistic factors have been taken into consideration, including the unidirectional links and loose-coupling relationship between nodes

uniformly visit the entire network space. Moreover even the channels may not all be identical; they may possibly have different propagation characteristics, and may support different sets of transmission rates. Much prior research on multi-channel networks has assumed identical channels and radio capabilities [5]. Flooding in mobile ad hoc networks has poor scalability as it leads to serious redundancy, contention and collision. It can also enhance the reliability of broadcasting. It can also be used in mobile and static wireless networks to implement scalable broadcast and multicast communications. Broadcasting is a fundamental and effective data dissemination mechanism for route discovery, address resolution and many other network services in ad hoc networks. While data broadcasting has many advantages, it also causes some problems such as the broadcast storm problem, which is characterized by redundant retransmission, collision, and contention. In a MANET, one challenging issue is to construct a virtual backbone [8] in a distributed and localized way while balancing several conflicting objectives: small approximation ratio, fast convergence, and low computation cost. Many existing distributed and localized algorithms select a virtual backbone without resorting to global or geographical information. However, these algorithms incur a high computation cost in a dense network. The simulation results showed that the proposed algorithm performs better with the end-to-end delay metric, throughput metric and packet delivery ratio metric. The proposed algorithm reduces the routing overhead and improves the performance of the entire network. As the performance of the proposed algorithm is analyzed between two metrics in future with some modifications in design considerations the performance of the proposed algorithm can be compared with other routing protocols. We have used a very small network of 50 nodes, as the number of nodes increases the complexity will increase.



III. B. LVC Algorithm

One drawback of heterogeneity of MANETs is that unidirectional links may exist between two neighbouring nodes (B-node or G-node). In LVC, unidirectional links in the network can be discovered using a BN discovery scheme. (1) Discovery of Bidirectional Links Bidirectional links are discovered by sending a neighbour discovery packet (BND) by a node to all its neighbours. This packet is used by nodes to create a bidirectional neighbour table BN.

Steps to discover Bidirectional links

Step 1: Each node sends BND packet to all its neighbouring nodes in a single hop.

Step 2: Wait for time T_{BND} and collect all BND packets from neighbour nodes. Use these packets to create an aware node (AN) table $AN = NBRB(g_i) \cap NGRG(g_i)$.

Step 3: Next, again send the BND table to all neighbouring nodes, now with node's AN table as well.

Step 4: The nodes check whether its own information is present in the BND packet from neighbour node. If yes the node is added to the BN table. (2) LVC To exploit the benefits of B-nodes, we design a novel LVC algorithm. In LVC, a B-node is chosen as the cluster head and establishes a loose coupling relationship with G-nodes. Two features appear in LVC. First, the loose clustering avoids heavy overhead caused by reconstructing and maintaining the cluster when the density of B-nodes is small. Second, LRPH

protocol can be adaptive to the density of B-nodes, even when all G-nodes are in the Gisolated state. All nodes build a local aware topology (LAT) table by exchanging control packets during building LVC. The basic step is building a local aware topology table (LAT).

Step 1: G-nodes send G-node initialization packets (GI) to all B-nodes in its AN table. The packet will have the information on its Bidirectional links.

Step 2: Each B-node once receiving the GI packets will add the BN to LAT. The B-node then sends B-node initialization (BI) packets to all G-nodes in its coverage area.

Step 3: Once G-node receives the BI packet, it updates the LAT table.

Step 4: A G-node declares it as a member to cluster head by sending cluster member, register (CMR) packet to cluster head.

Step 5: Cluster head replies with a cluster head declare (CHD) packet and updates it LAT. Cluster head maintains the LAT for each member G-node. 3) Cluster Head selection Each G-node, Gi selects the B-node which has the shortest distance (by any shortest path algorithms) to node Gi Using LAT table G-nodes can easily find out the B-node nearest to it.

IV. SIMULATION RESULTS

The proposed algorithm implemented with Network Simulator 2. Simulation parameters are as follows: The Distributed Coordination Function (DCF) of the IEEE 802.11 protocol is used as the MAC layer protocol. The radio channel model follows a Lucent’s Wave LAN with a bit rate of 2 Mbps, and the transmission range is 250 meters. We consider constant bit rate (CBR) data traffic and randomly choose different source-destination connections. Every source sends four CBR packets whose size is 512 bytes per second. The mobility model is based on the random waypoint model in a field of 1;000 m _ 1;000 m. In this mobility model, each node moves to a random selected destination with a random speed from a uniform distribution [1, max-speed]. After the node reaches its destination, it stops for a pause time interval and chooses a new destination and speed. In order to reflect the network mobility, we set the max-speed to 5 m/s and set the pause time to 0. The Max Delay used to determine the rebroadcast delay is set to 0.01 s, which is equal to the upper limit of the random jitter time of sending

broadcast packets in the default implementation of AODV in NS.

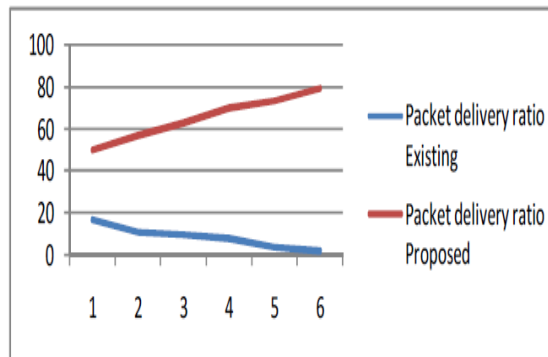


Figure.3 Performance Evaluation for Simulation time vs PDR

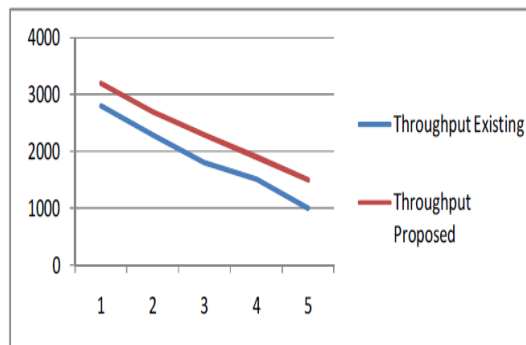


Figure.4 Performance Evaluation for Packet size vs Throughput

V. CONCLUSION AND FUTURE WORK

In this paper, we developed a loose virtual clustering based routing protocol named LRPH for power heterogeneous MANETs. We designed a loose virtual clustering algorithm to eliminate unidirectional links and to benefit from high-power nodes in transmission range, processing capability, reliability, and bandwidth, such that to change homogeneous network into effective heterogeneous network protocol. We focused on the IEEE 802.11-based power heterogeneous MANETs in this project. In 802.11-based power heterogeneous MANETs, mobile nodes have different transmission power, and power heterogeneity becomes a double-edged sword. To address this issue, we presented a loose-virtual-clustering-based routing protocol for power heterogeneous MANETs with Geo-routing. To reduce the interference raised by high-power nodes, we develop routing algorithms to avoid packet forwarding via high-power nodes, if not needed. And we have proposed Geo-routing technique to improve the Heterogeneous communication with low

overhead. The future work in the development of the proposed algorithm includes improvements to both the query localization and the load checking algorithm. Currently the location information used for the query localization is disseminated in an on-demand manner. Further techniques, which could possibly make the dissemination process faster and more efficient, have to be investigated.

ACKNOWLEDGMENT

The authors wish to thank their parents for supporting and motivating for this work. They are very thankful to the Radharaman Institute of Technology & Science, Bhopal (M.P.) with IPS College of Technology & Science Gwalior (M.P.) for supporting in contribution towards development of this Article.

REFERENCES

[1] Yuefeng Huang, Xinyu Yang, Shuseng Yang, Wei Yu, and Xinwen Fu, "A cross-layer approach handling link asymmetry for wireless mesh access networks," *IEEE Transactions on Vehicular Technology*, vol. 60, no. 3, pp. 1045–1058, Mar. 2011.

[2] Wei Liu, Chi Zhang, Guoliang Yao, Yuguang Fang, "Delar: A device energy-load aware relaying framework for heterogeneous mobile ad hoc networks," *IEEE Journal on Selected Areas in Communications*, vol. 29, no. 8, pp. 1572–1584, September 2011.

[3] X. Du, D. Wu, W. Liu, and Y. Fang, "Multiclass routing and medium access control

for heterogeneous mobile ad hoc networks," *IEEE Transactions on Vehicular Technology*, vol. 55, no. 1, pp. 270–277, January 2006.

[4] S. Yang, X. Yang, and H. Yang, "A cross-layer framework for position based routing and medium access control in heterogeneous mobile ad hoc networks," *Telecommunication Systems*, vol. 42, no. 1-2, pp. 29–46, October 2009.

[5] W. Liu, C. Zhang, G. Yao, and Y. Fang, "Delar: A device-energy-load aware relaying framework for heterogeneous mobile ad hoc networks," *IEEE J. Sel. Areas Commun.*, vol. 29, no. 8, pp. 1572–1584, Sep. 2011.

[6] A. Boukerche, "Performance evaluation of routing protocols for ad hoc wireless networks," *Mobile Networks and Applications*, vol. 9, no. 4, pp. 333–342, February 2004.

[7] A. Boukerche, B. Turgut, N. Aydin, M.Z. Ahmad, L. B'ol'oni, and D. Turgut, "Routing protocols in ad hoc networks: A survey," *Computer Networks*, vol. 55, no. 13, pp. 3032–3080, September 2011.

[8] P. Leonardi, E. Garetto, and M. Giaccone, "Capacity scaling in ad hoc networks with heterogeneous mobile nodes: The super-critical regime," *IEEE/ACM Trans. Netw.*, vol. 17, no. 5, pp. 1522–1535, Oct. 2009.

[9] V. Shah, E. Gelal, and P. Krishnamurthy, "Handling asymmetry in power heterogeneous ad hoc networks," *J. Comput. Netw.—Int. J. Comput. Telecommun. Netw.*, vol. 51, no. 10, pp. 2594–2615, Jul. 2007.

ANALYSIS OF VARIOUS CONTRAST IMPROVEMENT TECHNIQUES FOR DEHAZING AN IMAGE

Ashok Kumar Shrivastava

Asst. Prof., Dept. of Computer Science, ASET, Amity University, Gwalior (M.P)

Email: ashok79.shrivastava@gmail.com

Abstract

Haze removal also known as contrast improvement mention unique procedures that focus to minimize or eliminate the degradation that have arises while the digital image was captured. The degradation may be owing to different factors like respective target-camera motion, blur because of camera miss-focus, respective atmospheric instability and others. This paper has concentrated on the variety of contrast improvement techniques. Since haze depends on the informaion of scene depth which is unknown factor so dehazing is difficult task. Efficacy of fog is the function of distance between the camera and target. Thus, air light map estimation is needed to haze removal. The present dehazing techniques can be classified as: image enhancement and image restoration Although, the image enhancement does not consolidate the cause of fog degrade the class of image.

Keywords: Fog removal, image enhancement, visibility restoration, camera motion, atmospheric instability.

1. INTRODUCTION

Images of open air scenes recorded in bad weather suffer from destitute in contrast [1]. Under poor weather conditions, the light extends to a camera is severely scattered by the airspace. So the image is getting highly cheapen due to additive light. Additive light are form from disperse of light by tiny pieces of fog. Additive light is generated by mixing the perceptual light that is emitted from different light heads. This additive light is called air light. Air light is not uniformly dispenced in the image.

Bad weather reduces airspace visibility. Poor visibility cheapens the perceptual image quality and outcome of the computer vision algorithms such as surveillance, tracking, and navigation [1]. Thus, it is very vital to make these vision algorithms resilient to weather changes. From the aairspace point of view, climate conditions differ mostly in the types and dimensions of the particles present in the airspace. A great attempt has gone into measuring the dimension of these particles. Based on the type of the visual effects, bad climate conditions are widely organized

into two categories, steady and dynamic. In steady bad climate, constituent droplets are very compact and steadily levitate in the air. The examples of steady climate are fog, mist, and haze. In dynamic bad climate, constituent droplets are 1000 times sizeable than those of the steady climate. Rain and snow represent dynamic climate states.

There have been some remarkable efforts to reimpose images devalued by fog. The most common method known to magnify devalued images is histogram equalization. However, even though exhuastive histogram equalization is straightforward and rapid, it is not worthy because the fog's out-turn on an image is a function of the gap between the camera and the entity. Another effective method is to restore degraded images [10] is scene depth method but here required two images which are taken under different climate condition for balance the image quality. When using the wavelet method also demands several images to attain the enhancement. In all previous work consider the air light is uniformly distributed in the image. But originally the air light [5] is not equally

distributed. Another method is atmospheric model. This methods use physical models to divine the pattern of image devalued and then reimpose image contrast with appropriate compensations.

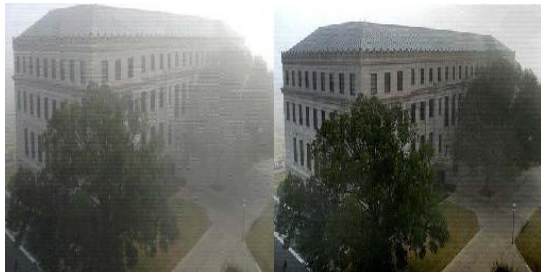


Fig. 1.1: Enhancement of Degraded Image[2]

They supply better image execution but usually entail extra information about the imaging system or the imaging environment.

The deriving rot in disparity varies across the scene and exponential in the depths of scene points. Therefore, customary volume invariant image processing techniques are not sufficient to remove weather effects from images. Here suggested a simple correction method of contrast loss in foggy images, in order to estimate the air light from a color image, a cost function is used for the RGB channel. However, it assumes that air light is uniform over the whole image. In this, existing method is improved to make it applicable even when the air light distribution is not uniform over the image [5]. In order to estimate the air light, a cost function that is based on the human visual model is used in the luminance image. The luminance image can be estimated by an appropriate fusion of the R, G, and B components. Also, the air light map is estimated using least squares fitting, which models the correspondance between topical air light and the coordinates of the image pixels.

1.2 PROBLEM DEFINITION

Taking an image in foggy climate state that images become devalued due to the existence of air light. It is known that under fog weather conditions, the disparity and color credibility of the images are drastically devalued. Clear day images have more contrast than foggy images. Hence, a fog removal algorithm should enhance the scene contrast. Enhancement of foggy

image is a provocation due to the convolution in recovering luminance and chrominance while maintaining the color fidelity. During intencification of foggy images, it should be kept in sense that over intencification leads to saturation of pixel value. Thus, intencification should be vault by some limitaion to avoid saturation of image and preserve appropriate color fidelity.

1.3 OBJECTIVE

To compare different methods to remove fog and find the research gap. Removal of fog is important for the tracking and navigation applications, consumer electronics, and entertainment industries. Fog devalued the perceptual image standard, thus the efficacy of computer vision algorithms based on small trait or high frequencies [16]. Removal of fog from images as a preprocessing expends the exactness of these computer vision algorithms. A feature point detector can unsuccessful if images have short visibility. If fog is separated and image is enhanced, then feature point detector can work with higher accuracy.

2. Related Work

Bad climate such as fog, mist and haze reduce atmospheric visibility. Poor visibility degrades perceptual image quality and performance of the computer vision algorithms such as surveillance, tracking and navigation. Thus, it is very vital to make these vision algorithms resilient to climate changes. Optically, poor visibility in bad climate is due to the considerable existence of water droplets. These droplets have significant dimension (1–10 mm) [1] and distribution in the participating medium. Light from the airspace and light reflected from an entity are scattered by these droplets, resulting the visibility of the scene to be degraded. Two fundamental phenomena that are consequence of scattering are ‘attenuation’ and ‘airlight’. Light shaft coming from a scene point, gets attenuated because of scattering by airspace particles. This phenomenon is termed as attenuation which reduces contrast in the scene. Light coming from the source is scattered towards camera and adds whiteness in the scene. This phenomenon is termed as airlight. It is noted that attenuation and airlight are

function of the distance between camera and object. Hence removal of fog requires estimation of depth map or airlight map. As a consequence, methods based on the use of multiple images are proposed. In [2] Schechner et al. suggested a method based on the use of images with different polarising filters. This requirement of filters is a big constrain for image acquisition and cannot be applied on the existing image databases. In past few years many methods [3–11] have been suggested for the removal of fog using single image. In [4] Fattal suggested a method based on ICA. This algorithm is computationally intensive and deeply based on colour information and thus cannot be applied for grey image. This method fails when images are degraded by dense fog because the foggy image is colourless. In [5] Tan removed fog by maximising local contrast of image but restored image looks over saturated. This method has advantage of easier application on many kinds of images. Kopf et al. [6] suggested a method based on the use of three-dimensional (3D) model of the scene. This method is application dependent and needs

input from an expert. He et al. [7] suggested a method based on dark channel prior and soft matting. Here airlight map is estimated using dark channel prior and refined by soft matting. But when scene objects are bright similar to atmospheric light, underlying assumptions of this method are not valid. Tarel and Hautiere [3] suggested a method based on linear operations but this method requires many parameters for adjustment. In [10] Fang et al. suggested a method based on the graph-based segmentation. Initial transmission map is estimated according to black body theory and refined by bilateral filter. It is noted that for the foggy image choice of control parameters of segmentation is difficult. In [11] Zhang et al. suggested a local albedo insensitive image dehazing method. This method is based on iterative bilateral filter. This algorithm gives good results. Owing to the use of iterative bilateral filter this technique is computationally intensive and requires choice of number of parameters (viz. spatial and intensity kernels of bilateral filter and number of colour groups) for optimal results. Values of these parameters vary from image to image.

3. Comparison of Various Contrast Improvement Techniques for fog Removal

Here is the comparison of various contrast improvement techniques of last decade given in the tabular form. Mostly worked on color and gray image to rectify problem of fog. During the comparison of differernt methods there is gap found in the study which is giving in the next section.

Authors	Bit of input image(s)	Belifes	Types of image
Oakley (1998)	Multiple	Understanding of scene depth	Gray
Schenchner (2001)	Multiple	Light disseminate by tiny pieces of airspace is partially polarized	Color & gray
Narasimhan (2002)	Multiple	Uniform poor climate state	Color & gray
Narasimhan (2003)	Single	Interactive	Color & gray
Oakley (2007)	Single	Airlight is unchanged every portion in the image	Color & gray
Kim (2008)	Single	Cost function based on human visual model	Color
Kopf (2008)	Single	Interactive	Color & gray
Fattal (2008)	Single	Shading and transmission functions are locally discontinuous	Color
Tan (2008)	Single	Based on spatial regularization and scalation of local contrast	Color & gray

He (2009)	Single	Based on dark channel prior	Color & gray
Tarel (2009)	Single	Based on airlight as a percentage between local standard deviation and local mean of whiteness	Color & gray
Zhang . (2010)	Single	Under the assumption that large-scale chromaticity inequalities are because of transmission while small scale luminance variations are because of scene Albedo	Color & gray
Fang (2010)	Single	Based on blackbody theory and graph based image segmentation	Color & gray
A.Tripathi (2012)	Single	HE and anisotropic diffusion	Color & gray

4. GAPS IN RELATED WORK

Fog removal algorithms become more beneficial for numerous vision applications. It has been originated that the most of the existing research have mistreated numerous subjects. Following are the various research gaps concluded using the related work:-

- (a) The presented methods have neglected the techniques to reduce the noise matter, which is given out in the output images of the existing fog removal algorithms.
- (b) Not much attempt has concentrated on the united approach of the CLAHE and Dark channel prior.
- (c) The problem of the uneven illuminate is also neglected by the most of the researchers.

5. CONCLUSION AND FUTURE WORK

Fog removal algorithms have become more applicable formany vision approach. It is confirmed that majority of the existing researchers have neglected many issues; i.e. no technique is precise for different kind of set of condition. The existing methods have neglected the use of histogram stretching and Gabor filter to reduce the noise problem which will be presented in the output image of the existing fog removal algorithms. To defeat the problems of existing research a new united algorithm will be proposed in near future. New algorithm will unite the dark channel prior, CLAHE and histogram stretching to improve the results further. The Gabor filtering is also done as a pre-processing step to remove the nosie form the input image.

6. References

[1]Garg, K., Nayar, S.K.: ‘Vision and rain’, Int. J. Comput. Vis., 2007, 75,(1), pp. 3–27.

[2] Schechner, Y.Y., Narasimhan, S.G., Nayar, S.K.: ‘Instant dehazing of images using polarization’. IEEE Computer Society Conf. onComputer Vision and Pattern Recognition, 2001, pp. 325–332.

[3] Tarel, J.P., Hautiere, N.: ‘Fast visibility restoration from a single color or gray level image’. IEEE Int. Conf. on Computer Vision, 2009, pp. 2201–2208

[4] Fattal, R.: ‘Single image dehazing’. Int. Conf. on Computer Graphics and Interactive Techniques archive ACM SIGGRAPH, 2008, pp. 1–9

[5] Tan, R.T.: ‘Visibility in bad weather from a single image’. IEEE Conf. on Computer Vision and Pattern Recognition, 2008, pp. 1–8

[6] Kopf, J., Neubert, B., Chen, B., et al.: ‘Deep photo: model-based photograph enhancement and viewing’, ACM Trans. Graph., 2008, 27, (5), p. 116:1–116:10

[7] He, K., Sun, J., Tang, X.: ‘Single image haze removal using dark channel prior’. IEEE Int. Conf. on Computer Vision and Pattern Recognition, 2009, pp. 1956–1963.

[8] Kim, D., Jeon, C., Kang, B., Ko, H.: ‘Enhancement of image degraded by fog using cost function based on human visual model’. IEEE Int. Conf. on Multisensor Fusion and Integration for Intelligent Systems, 2008, pp. 163–171.

[9] Yu, J., Xiao, C., Li, D.: ‘Physics-based fast single image fog removal’. IEEE Int. Conf. on Signal Processing (ICSP), 2010, pp. 1048–1052.

[10] Fang, S., Zhan, J., Cao, Y., Rao, R.: ‘Improved single image dehazing using segmentation’. IEEE Int. Conf. on Image Processing (ICIP), 2010, pp. 3589–3592

- [11] Zhang, J., Li, L., Yang, G., Zhang, Y., Sun, J.: 'Local albedo-insensitive single image dehazing', *Vis. Comput.*, 2010, 26, (6–8), pp. 761–768.
- [12] Narasimhan, S.G., Nayar, S.K.: 'Chromatic framework for vision in bad weather'. *IEEE Conf. on Computer Vision and Pattern Recognition*, 2000, vol. 1, pp. 598–605.
- [13] Gonzales, R.C., Woods, R.E.: 'Digital image processing' (Addison- Wesley, Reading, MA, 1992, 2nd edn.)
- [14] Perona, P., Malik, J.: 'Scale space and edge detection using anisotropic diffusion', *IEEE Trans. Pattern Anal. Mach. Intell.*, 1990, 12, (7), pp. 629–639
- [15] Economopoulou, T.L., Asvestasa, P.A., Matsopoulos, G.K.: 'Contrast enhancement of images using partitioned iterated function systems', *Image Vis. Comput.*, 2010, 28, (1), pp. 45–54
- [16] Hautiere, N., Tarel, J.P., Aubert, D., Dumont, E.: 'Blind contrast enhancement assessment by gradient ratioing at visible edges', *J. Image Anal. Stereology*, 2008, 27, (2), pp. 87–95
- [17] AK Tripathi and S Mukhopadhyay, "Single Image Fog Removal using anisotropic Diffusion " ,*IET Image Processing*, 2012 Vol. 6, Iss. 7, pp. 966-975

A SHORT REVIEW ON SOLAR WATER DISTILLATION FOR GETTING FRESH WATER IN RURAL AREA

Abhay Agrawal¹, R. S. Rana², P.K. Shrivastava³, R.P. Singh⁴

¹Assistant Professor, Dept. of Mechanical Engg., Rewa Engineering College, Rewa, (M.P)

²Assistant Professor, Dept. of Mechanical Engg., MANIT, Bhopal (M.P)

³Associate Professor, Dept. of Mechanical Engg, Rewa Engineering College, Rewa, (M.P)

⁴Associate Professor, Dept. of Mechanical Engg, IPS-CTM, Gwalior (M.P)

Email: abhayagrawalgec@gmail.com¹, ravindrana74@gmail.com², pankajks2007@gmail.com³, rpsipsgwl@gmail.com⁴

Abstract

Water is very essential for human life as it is a god like thing. Due to high growth of population and industrial developments especially from the early 20th century, people living in rural areas and remote villages suffer with shortage of drinking water. People living in urban and rural areas depend on surface and ground water sources, where these sources are majorly polluted by industrial waste. The use of reverse osmosis technique and other conventional technique appears to be costlier technologies and requires a very large land mass. An economical method of converting the saline water to potable water is by using solar energy. Solar still desalination is one method of converting saline water into potable water by evaporation and condensation. Many researchers carried out extensive studies on the solar still desalination technique and this paper communicates a detailed review about the existing desalination technique by solar energy.

Keywords: Desalination, still, Wick, Phase Change Material

1. Introduction

Energy and water are very important for life on Earth and sustain the modern world. In many parts of the developed world, the control and utilization of water and energy has driven economic development and progress. In the developing world, many regions suffer from shortages of fresh drinking water and energy supplies. The United Nations Environment Program (UNEP) stated that one third of the world's population live in countries with insufficient fresh drinking water to support the population. Consequently by 2025, two thirds of the world population will face water scarcity.

Drinking water of acceptable quality has become a scarce commodity. The World Health Organization estimates that over a billion people lack access to purified drinking water and the vast majority of these people are living in rural

areas where the low population density and remote locations make it difficult to install traditional clean water solutions [1]. In India two third of population live in rural areas and fresh water crisis is already evident in many rural parts of India. The fresh drinking water crisis is not the result of natural factors, but has been caused by human actions for satisfying the need. India's rapidly increasing population and changing lifestyles, also satisfy the need for fresh water. Intense competition among competing user's agriculture, industry and domestic sector is driving the ground water table deeper and deeper. Some 45 million people are affected by water quality problems caused by pollution, by excess level of mercury, fluoride, arsenic, iron or by the saltiness of water. Millions of people do not have adequate quantities of safe water. In rural areas, women and girls still have to walk

long distances and spend up to many hours every single day to provide the household with water. Scarcity of fresh water problems are facing many arid zones of Gujarat and Rajasthan, while these places are getting more amount of solar energy, apart Gujarat and Rajasthan that in western India, which face water shortage and have huge underground saline water sources, certain regions in Haryana state and Maharastra states also have underground saline water in spite of high rain fall [2].

Distillation process is widely used for purification of water. Different methods of distillation have been used in several countries to resolve the crisis of drinking water. A variety of distillation technologies has been developed over the years on the basis of thermal distillation, membrane separation, freezing, electrodialysis, etc. The conventional water distillation processes consume larger amount of energy to separate a portion of pure water from the saline water. The physical change in the state of water as well as filtering via membrane processes, such as Multi Stage Flash (MSF) distillation, Multiple Effect Distillation (MED), Vapor Compression (VC) distillation, Reverse Osmosis (RO), and Electro-dialysis (ED) are most often used to treat saline water. Some of these processes are complex, requiring skilled operation and maintenance, and

not considered to be energy efficient and economical.

Solar desalination is a very promising alternative that can partially support the human needs for fresh water with an environment-friendly energy source. It exhibits a considerable economic advantage over other desalination processes due to cost-free resource and reduced operation and maintenance cost. Solar desalination is a process where solar energy is used to produce fresh water from saline or brackish water for drinking, domestic and other purposes. The simple and independent operation of solar distillation unit is highly suitable for small scale and remote applications. It provides an opportunity for rural communities to prepare their own potable water at considerably lower prices. Solar water distillation has begun over a century ago. In 1872, a solar plant with capacity around 4000 m² has been built in Chile and successfully ran for many years. In addition, the small plastic solar stills have been employed to provide potable water for life rafts floating in the ocean during World War II. Thus, the use of solar energy with water distillers has a long history and the technology is well improved and field tested throughout the world. The classification of solar desalination is shown in fig. 1

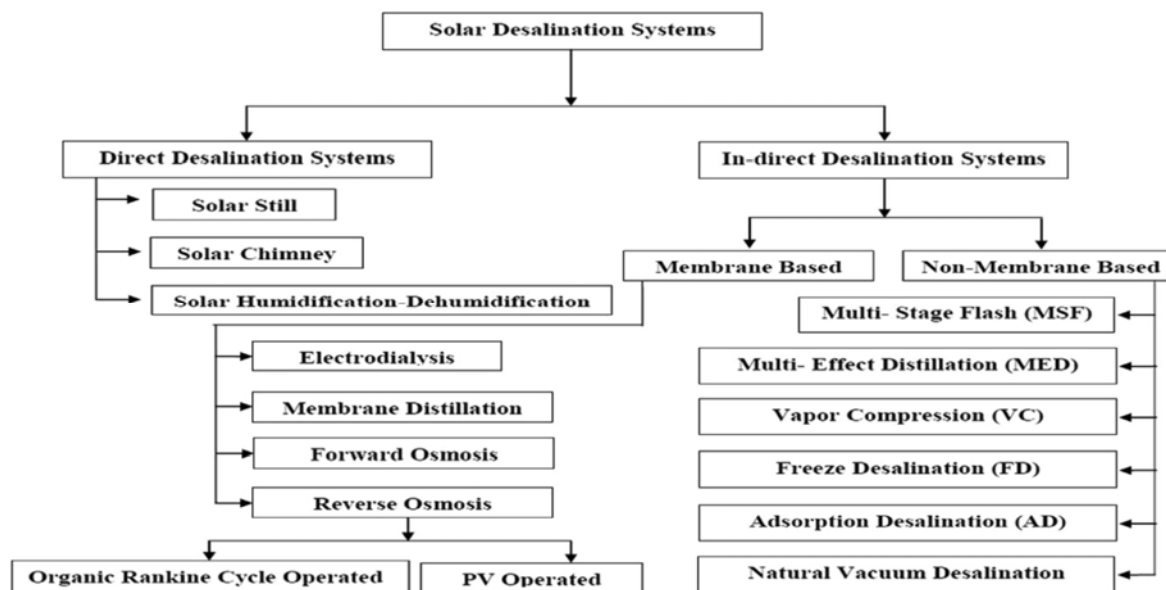


Fig. 1. Classification of solar desalination systems [3].

2. Solar Still

A solar still is a very simple device by which can be converted saline, brackish water into drinking water. Solar stills work exactly the same

processes which in nature generate rainfall, namely evaporation and condensation. Its working is very simple; a transparent cover (glass/plastic) encloses a pan or box of saline

water and latter store solar energy within the enclosure. This heats up the water causing evaporation and condensation on the inner face of the sloping transparent cover. This distilled water is generally drinkable; the quality of the

distillate water is very high because all the salts, inorganic and organic components and microbes are left behind in the pan. A schematic diagram of simple solar still is shown in Fig. 2.

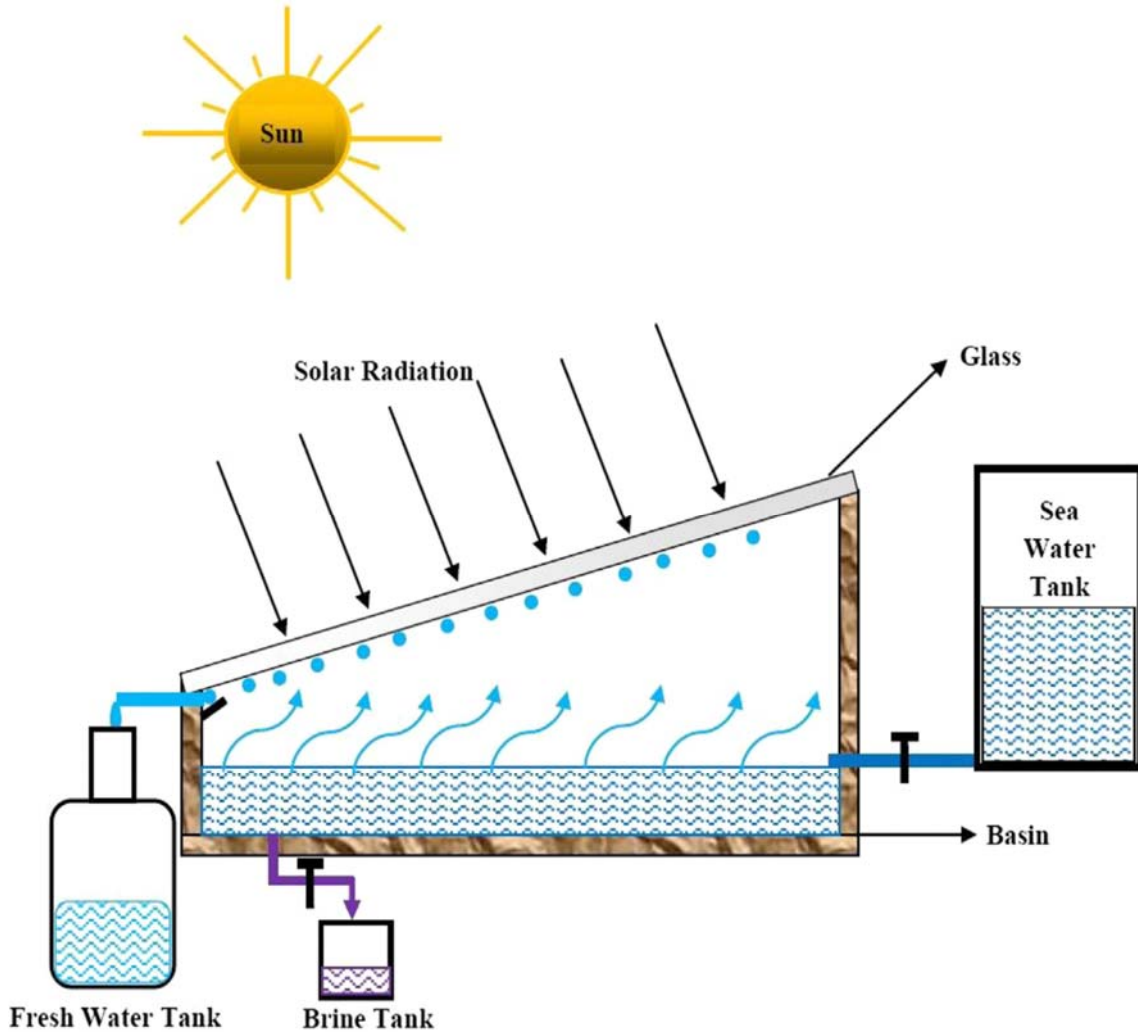


Fig. 2. Simple solar still [4].

3. Classification of Solar Stills

Solar stills are classified into two categories mainly single effect solar stills and multi-effect solar stills. Single effect solar stills are further classified into two groups: Passive solar stills and Active solar stills. The schematic

representation of single effect solar stills is shown in Fig. 3. Passive solar stills utilize the internal heat trapped inside the still for the evaporation process, while active stills make use of external sources, such as solar collectors or waste heat from industries.

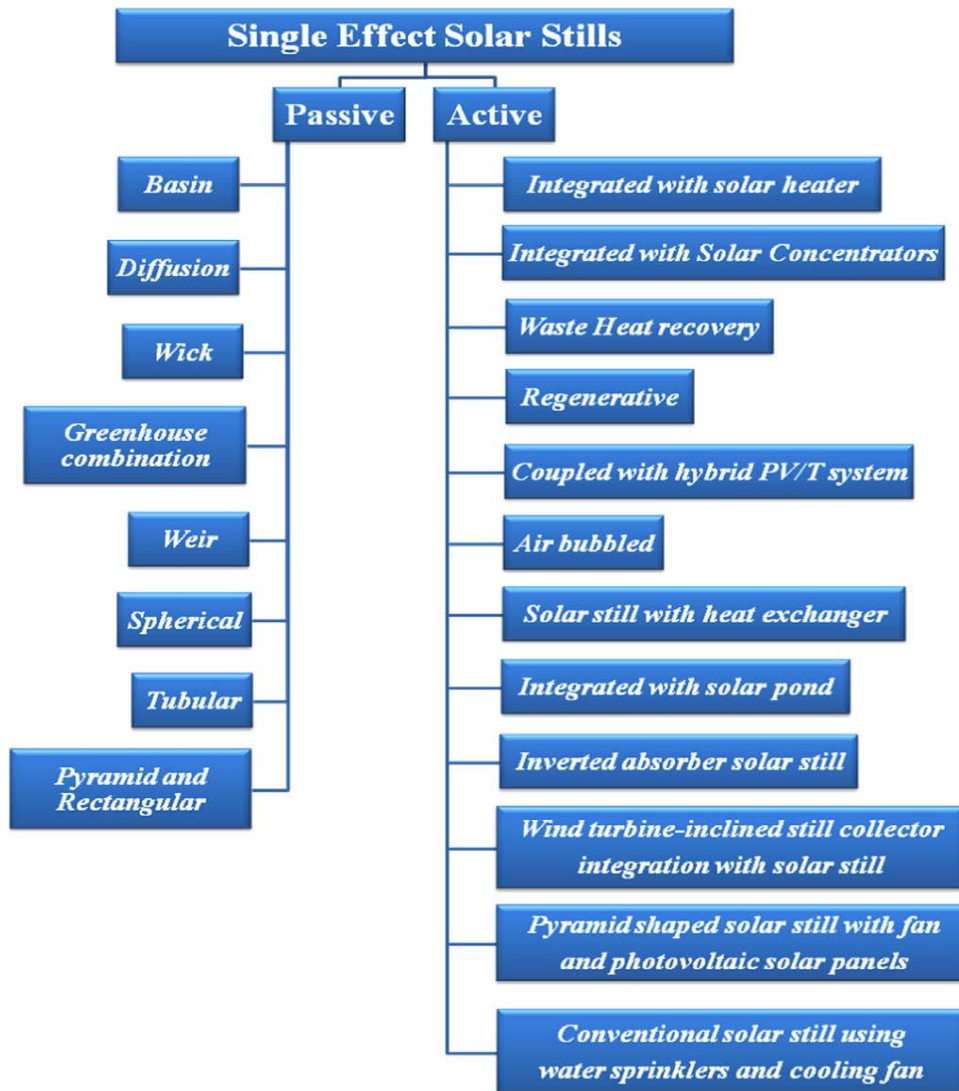


Fig. 3. Various designs of single effect passive and active solar stills[5]

3.1 Passive type solar stills

3.1.1. Single basin single slope solar still

In which solar energy collected by bottom elements (basin liner) itself for evaporation of brackish water. The simple single slope solar still is shown in Fig. 4. The sun’s energy in the form of short electromagnetic waves passes through a clear glazing surface such as glass. Upon striking a darkened surface, this light changes wavelength, becoming long waves of heat, which is added to the water in a shallow basin below the glazing. As the water heats up, it begins to evaporate. The warmed vapor rises to a cooler area. Almost all impurities are left behind on the

basin. The vapor condenses on to the underside of the cooler glazing and accumulates in to water droplets or sheets of water. The combination of gravity and the tilted glazing surfaces allows the water to run down the cover and into a collection trough, where it is channeled in to storage. The performance of a basin type single slope solar still system was investigated by Abdallah et al. [6]. In this system, the performance of the solar still is improved by increasing the production rate of distilled water The experimental result shows that the use of internal mirrors improved the system thermal performance upto30%.

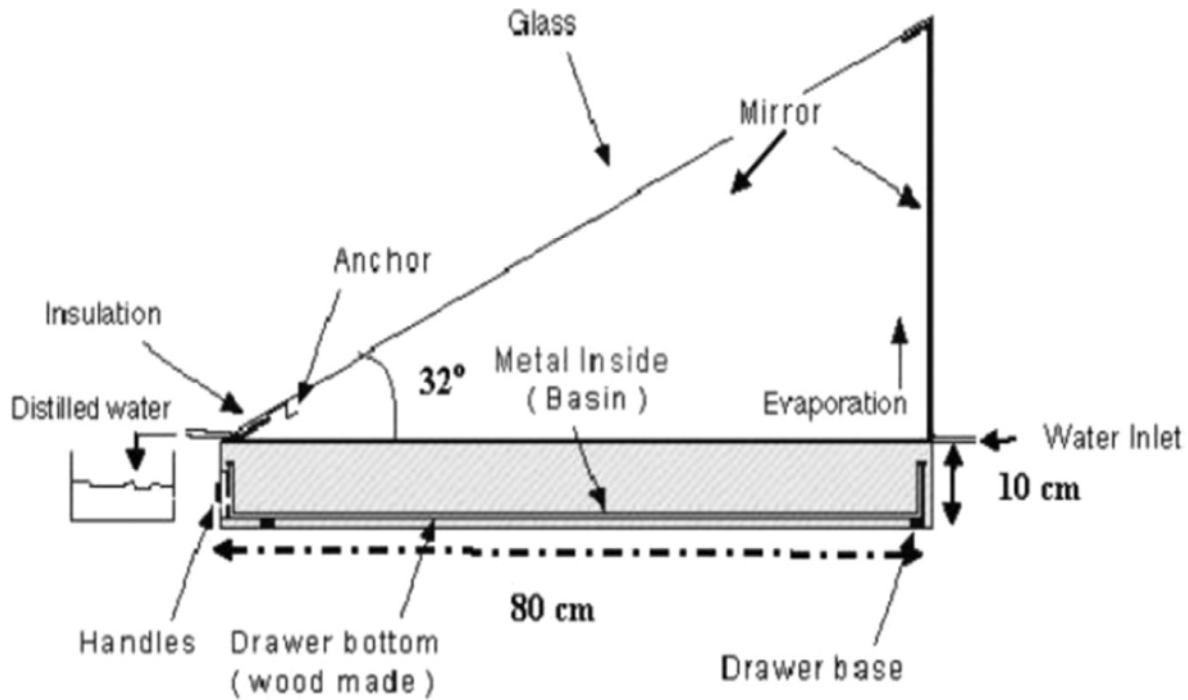


Fig. 4. Schematic diagram of a single slope solar still [6].

3.1.2. Basin stills with internal and external reflectors

A basin still with internal and external reflectors was designed by Tanaka [7] as shown in Fig. 5. The still consists of a basin liner, internal reflectors in two sides and back walls, a glass cover, and a vertical external reflector. Because of the usage of reflectors, more solar radiation is

introduced into the still compared to conventional solar stills and thus it was reported that there was an increment in the daily productivity by 70–100% on winter days. Tanaka and Nakatake [8] presented a theoretical analysis and they observed that year round average increase in the daily productivity was 48%.

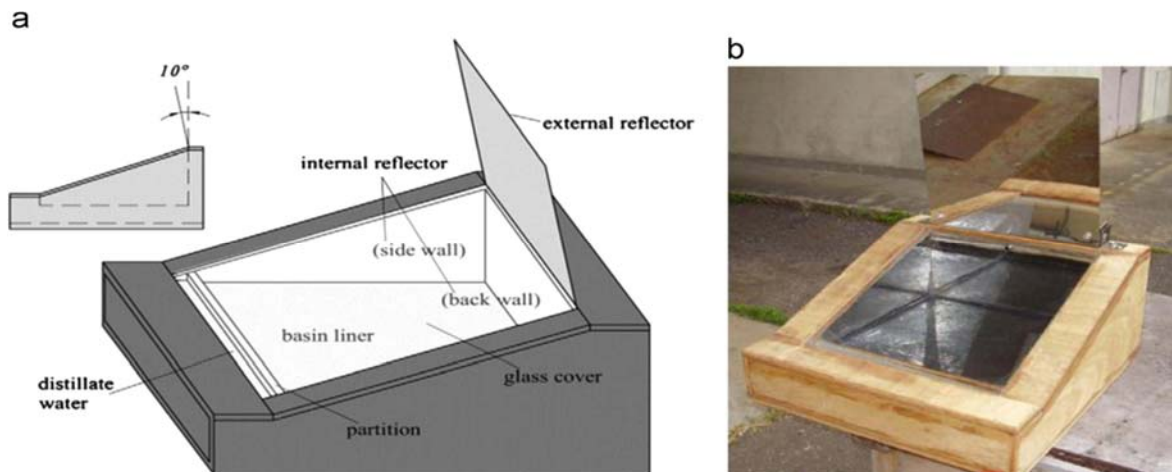


Fig. 5. Single slope still with internal and external reflectors; (a) schematic (b) experimental setup [7].

3.1.3. Solar still with sponge cubes

Sponge cubes in the brackish water was used by Abu-Hijleh and Rababa'h [9] to improve the rate of evaporation. The schematic diagram is shown in Fig. 6. The effects of sponge cube size, percent volume of sponge, water depth, water salinity

and the use of black coal and black steel cubes were also investigated. They had proved that the distillate productivity increased by 18–273% compared to an identical conventional still without sponge cubes under the same conditions.

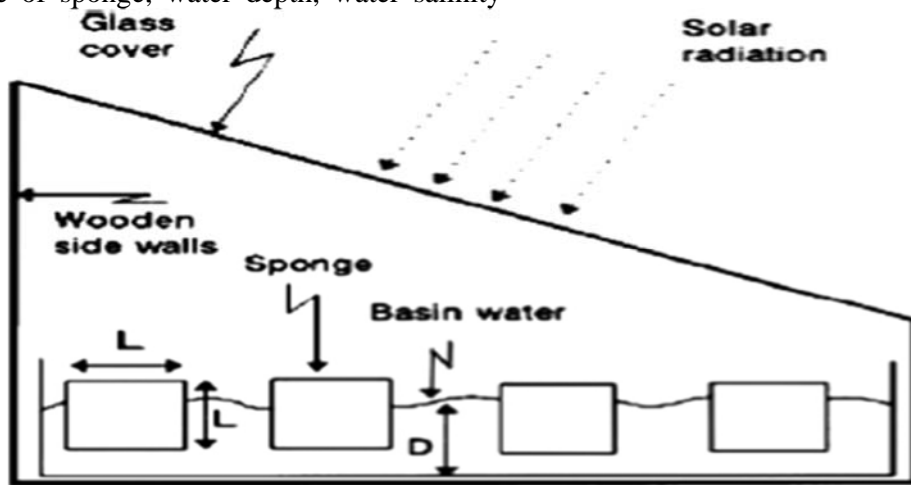


Fig.6. Single slope still with sponge cubes [9].

3.1.4. Solar still with multiple low thermal inertia porous absorbers (blackened jute cloth)

An experimental and theoretical work was proposed by Srivastava and Agrawal [10] to enhance the performance of conventional single

slope basin type solar still by incorporating multiple low thermal inertia porous absorbers (blackened jute cloth), floating adjacent to each other on the basin water with the help of thermocol insulation .the schematic diagram is shown in Fig. 7.

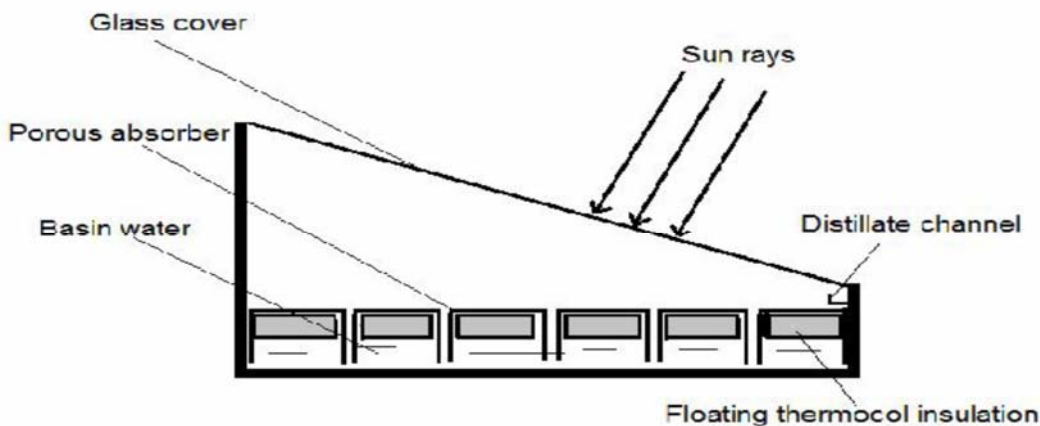


Fig. 7. Single slope still with porous absorber on the thermocol insulation [10]

In the modified solar still, nine such absorber pieces were floated side by side length wise on the basin water so that the water surface was

completely covered by the absorber with required clearance from the basin walls. The edges of the jute cloth were dipped in the basin

water, so that it remained wet due to capillary action. The performance of the modified still was compared with the perfectly synchronized conventional basin type solar still of identical dimensions and found an increase of 68% and 35% in the distillate yield on clear and cloudy days. The effect of basin water depth and the improvement in productivity by the use of twin reflector booster were also experimentally investigated and found an increase in the yield by 79%.

3.1.5. Solar still with rotating shaft

Abdel-Rehima and Lasheen [11] worked on improving the performance of solar desalination systems with a modification of using a rotating shaft installed close to the basin water surface. The schematic diagram is shown in Fig. 8. The results showed that an enhancement of distillate yield by 2.5% at May, 5% at June, and 5.5% at July respectively.

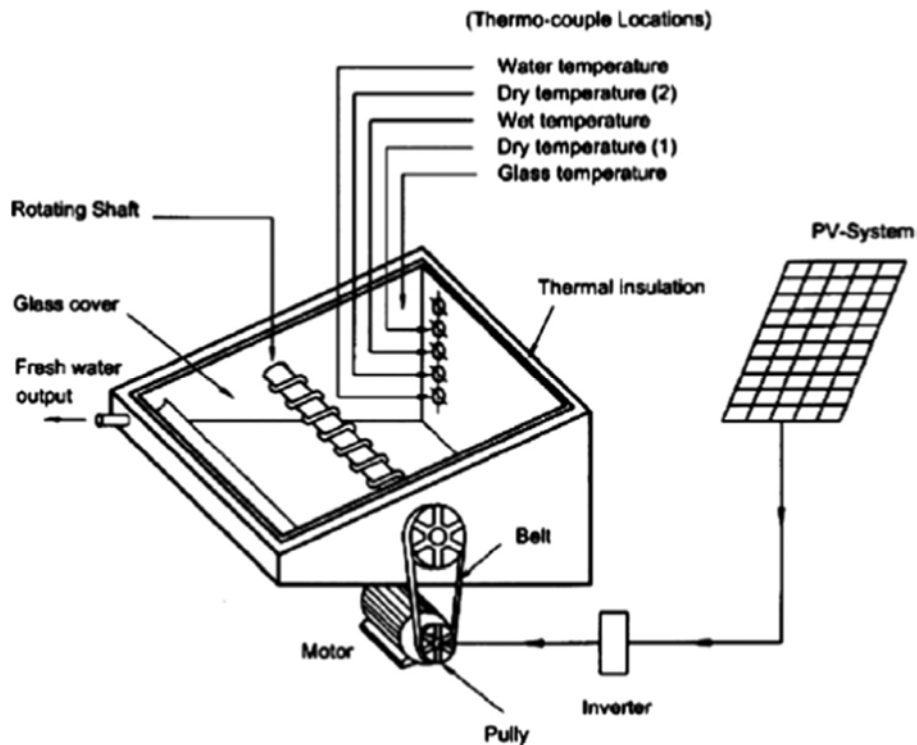


Fig. 8. Single slope still using rotating shaft [11].

3.1.6. solar still with phase change material

El-Sebaï et al. [12] proposed mathematical model for a single slope single basin solar still with and without phase change material (PCM) under the basin liner of the still. Numerical calculations were carried out using thin layer of stearic acid as a PCM on the beneath of the basin liner. It is shown in Fig. 9. The results of that study showed that, productivity daylight decreased as mass of the PCM increased; but productivity overnight and daily productivity

were increased significantly with an increase of mass of the PCM due to the increased amount of the stored heat within the PCM. During discharging of the PCM, the convective heat transfer coefficient from the basin liner to basin water is doubled; thus, the evaporative heat transfer coefficient is increased by 27% on using 3.3 cm of stearic acid beneath the basin liner. Therefore, on a summer day, a value of daily productivity of 9.005 L/m²/day with a daily efficiency of 85.3% has been obtained compared to 4.998 L/m²/

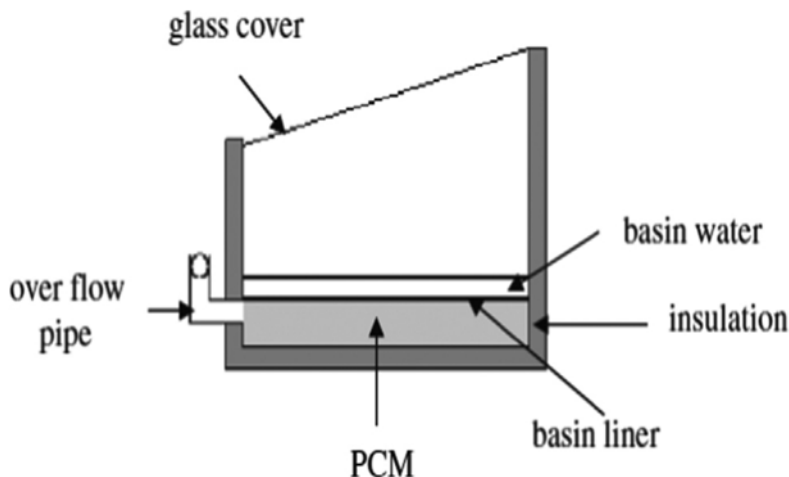


Fig. 9. Schematic diagram of the single slope-single basin solar still with PCM [12].

3.1.7. Wick type solar stills

Wick still mainly come under inclined type still. In a wick still, the feed water flows slowly through a porous, radiation-absorbing pad (the wick). A schematic diagram of multi-wick type solar still is shown in Fig. 10. In which blackened wet jute cloth forms the liquid surface which can be oriented to receive maximum solar radiation and a smaller mass of water will be heated to higher temperature and will evaporate rapidly. The wet surface is created by a series of jute cloth pieces of increasing length separated by thin polythene sheets, these pieces are arranged along an incline and the upper edges are dipped in a

saline water tank. Suction by the capillary action of the cloth fiber, provides a surface of the liquid, irradiated by the sun is wet at all times; the portion of a piece of cloth, covered by the polythene sheet does not suffer evaporation and hence the exposed portion of the piece retains wetness. M.S. Sodha et al. [13] observed that, overall efficiency of multiple wick solar still is 4% higher than the basin type still. Their results also show that, the still cost less than half of the cost of a basin type still of same area and provide a higher yield of distillate.

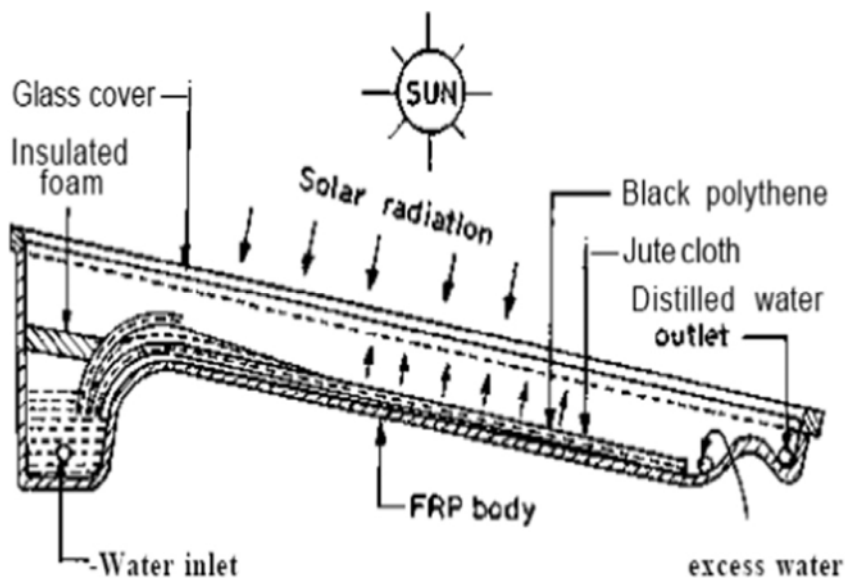


Fig. 10. Schematic representation of wick type solar still [13].

3.1.8. Concave surface type solar still

Concave wick type solar still is designed and made by Kabeel [14]; a concave shaped wick surface increases an evaporation rate because the water surface level is lower than the upper limit of the wick surface. It is shown in Fig. 11.

Results show that average distillate productivity in day time was 4.1 L/m² and the maximum instantaneous system efficiency was found to be 45% and the daily efficiency of the still was 30%. The maximum hourly yield was 0.5 L/h per m² after solar noon.

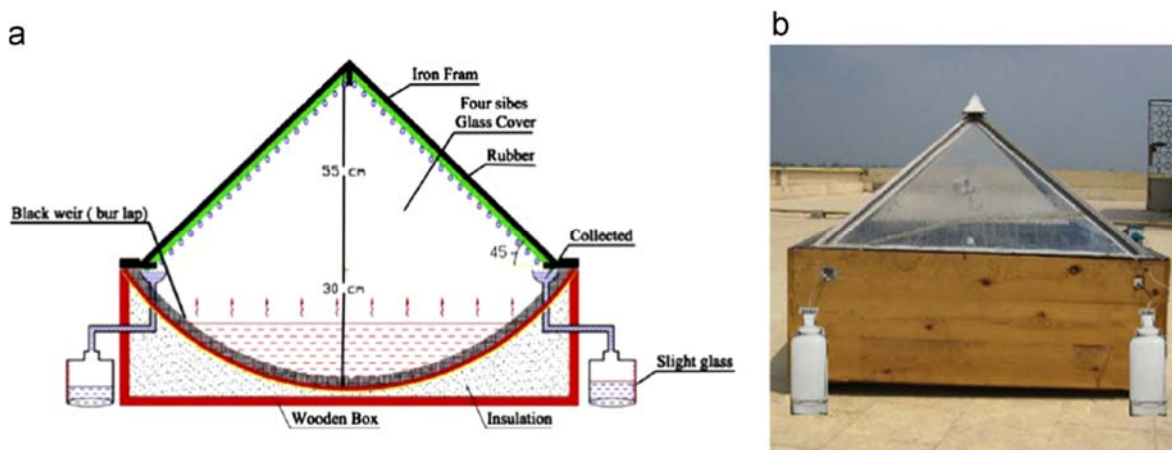


Fig. 11. Concave type solar still; (a) schematic diagram (b) experimental setup [14].

4. Conclusion

On the basis of survey of review in various solar stills, the following conclusion can be inferred.

(a) In the countries like India, where there are large parts of remote and rural areas with sufficiently high solar energy input. Solar distillation can be a feasible option for obtaining potable water.

(b) Solar distillation can be a very economical option as the cost of the solar still can be recovered within a year of operation.

(c) Solar energy is abundant, never lasting, available on site with free of cost and pollution free energy. (d) Solar stills have a good chance of success in India for lower capacities which are more than 20 km away from the source of fresh water and where the TDS of saline water is over 10,000 ppm.

(e) The floating absorber sheet improves the output of the still compared to an ordinary conventional

(f) The multiple wick solar still is the most economic and efficient among the existing solar stills.

(g) To decrease fresh water costs, efforts should be undertaken on the following research topics, storage studies, insulation studies, thermo-optical studies for the condensing covers, geometry and design studies.

References

1. Qiblawey, H. M., & Banat, F. (2008). Solar thermal desalination technologies. *Desalination*, 220, 633–644.
2. Gomkale SD, Datta RL. Some aspects of solar distillation for water purification. *Solar Energy* 1973;14(4):387–92.
3. Ali MT, Fath HES, Armstrong PR. A comprehensive techno-economic review of indirect solar desalination. *Renew Sustain Energy Rev* 2011; 15: 4187–99.
4. Setoodeh N, Rahimi R, Ameri A. Modeling and determination of heat transfer coefficient in a basin solar still using CFD. *Desalination* 2011; 268:103–10.
5. P. Vishwanath Kumar, Anil Kumar, Om Prakash, Ajay Kumar Kaviti. Solar stills system design: A review. *Renewable and Sustainable Energy Reviews* 51 (2015) 153–181.
6. Abdallah Salah, Badran Omar, Abu-Khader Mazen M. Performance evaluation of a modified design of a single slope solar still. *Desalination* 2008; 219:222–30.
7. Tanaka H. Experimental study of a basin type solar still with internal and external reflectors in winter. *Desalination* 2009; 249:130–4

8. Tanaka H, Nakatake Y. Theoretical analysis of a basin type solar still with internal and external reflectors. *Desalination* 2006; 197: 205–16.
9. Abu-Hijleh B A, Rababa'h H M. Experimental study of a solar still with sponge cubes in basin. *Energy Convers Manag* 2003; 44:1411–8.
10. Pankaj K. Srivastava, S.K. Agrawal, Experimental and theoretical analysis of single sloped basin type solar still consisting of multiple low thermal inertia floating porous absorbers, *Desalination* 311 (2013) 198–205.
11. Abdel-Rehima Z S ,Lasheen A .Improving the performance of solar desalination systems. *Renew Energy* 2005; 30:1955–71.
12. A.A. El-Sebaili, A.A. Al-Ghamdi, F.S. Al-Hazmi, Adel S. Faidah, Thermal performance of a single basin solar still with PCM as a storage medium, *Appl. Energy* 86 (2009) 1187–1195.
13. Sodha MS, Kumar Ashvini, Tiwari GN, Tyagi RC. Simple multiple wick solar still: analysis and performance. *Solar Energy* 1981; 26(2):127–31.
14. A.A. Kabeel, Performance of solar still with a concave wick evaporation surface, *Energy* 34 (2009) 1504–1509.

ROLLING ELEMENT BEARING FAULT DETECTION THROUGH ADAPTIVE FILTERING WAVELET TRANSFORM USING VIBRATION & CURRENT SIGNALS

Gajendra Dubey¹, Rajiv Dwivedi²

¹PG Scholar, Department of Mechanical Engineering, MITS Gwalior (M.P)

²Associate Professor, IPS-CTM, Gwalior (M.P)

Email: gajendra7704@gmail.com¹, rajivdwivedi81@gmail.com²

Abstract

This paper deal with a new scheme for the adaptive filtering algorithm of wavelet transforms. This algorithm is based on localized defects in ball bearing based on wavelet transform at different scales ,bearings are the major components of rotating machinery prone to failure , hence need to monitor their condition and maintain them ,Although various bearings fault detection methods based on different technologies are present and implemented there is a need an accurate fault detection system, In this present work, to eliminate the limitations and merge the advantages of these two techniques an integrated technique based on weak signals(Vibration and Current signature) . For normal ball bearing, bearings with inner race fault, outer race fault and rolling ball fault are acquired from a motor-driven experimental system, The wavelet transform was used to process the accelerometer signals and to generate feature vectors, The weak signal with noise is decomposed by wavelet multi-filtering, the filter filtered out the noise in order to detect the weak signal. The traditional adaptive filter, and adaptive filtering algorithm of wavelet transform were compared and simulated using the MATLAB software, The results show that: adaptive filtering algorithm of wavelet transform for weak signal detection method can more effectively defect weak signal from containing the noise signal than the traditional adaptive filtering algorithm

Keywords: Weak signal detection, Wavelet decomposition, Adaptive filtering

1. INTRODUCTION

At present, no matter in the practical engineering or theory study, weak signal detection is an important research topic from the noise signal. When the weak signal is interfered by wide bandwidth noise, setting the parameter of the traditional adaptive filtering algorithm is difficult. Wavelet analysis has a good ability to distinguish time-frequency signal processing to become a powerful tool [1]. In the field of signal processing, Using wavelet transform in signal de-noising has gained more and more extensive application [2]. Rolling element bearing defects are classified as firstly on the basis of fault

location and secondly on the basis of their fault type, It may be single point defect or it may be multi point defect as in [3]. Numbers of researchers are interested in finding the location of fault.

The main purpose of installing the rolling element bearing in machinery is to hold or support an element and transmit the moment of the load to the another element. When a machine rotates by drive, the Shaft bearing response to the vibrations of the drive is main cause of vibration. All drives have nature to vibrate (*Vibrations cannot be eliminate*) and itself is not a fault. However excess of vibration can be a symptom of a developing fault and an early

warning of machine failure. Many methods for rolling element bearing fault diagnosis are presented in the literature on the basis of their different fault characteristics listed in [4]. When the signal is analyzed as a function of time then analysis is called time domain analysis. Time domain analysis has been performed to monitor the bearing health condition in [5]. This technique has been further subdivided as time waveform analysis and time indices as in [6]. How to set up, acquire and manipulate time waveform data is detailed in [7] proposes a method of the nonlinear wavelet threshold de-noising. So the paper combines the method of the wavelet transform and the adaptive filtering, proposing the adaptive filtering algorithm of wavelet transform. Mallet algorithm was adopted, which can decompose the input orthogonal vector in multi-scale space, and reduce spectrum dynamic range of input vector autocorrelation array of the adaptive filter in order to improve the LMS convergence speed and stability. Through analyzing the weak signals detection in the practical engineering, the results show that the method based on adaptive filtering algorithm of wavelet transform is better than the traditional adaptive filtering.

2. ADAPTIVE FILTERING ALGORITHM OF WAVELET TRANSFORM

2.1 Multi-resolution analysis of wavelet transformation

Wavelet analysis has the characteristics of multi-resolution analysis, which has a wide range of application. The basic concept of wavelet are as follows: if $\Psi(t) \in L^2(R)$, and Fourier transform $\Psi(\omega)$ meets the allowable condition, so $\Psi(\varphi)$ is called a basis wavelet or mother wavelet. The wavelet transform of $f(t)$ is defined as:

$$W_\varphi f(t)(a,b) = \langle f(t), \varphi_{a,b} \rangle = |a|^{-\frac{1}{2}} \int_R f(t) \left(\frac{t-b}{a} \right) dt \quad (1)$$

Where, a is scale factor, b is translation factor. The concept of multi-resolution analysis was proposed by Mallet, when he structured orthogonal wavelet basis [7], which illustrated the multi-resolution properties of wavelet from the concept of space, and unified the method of orthogonal wavelet basis, and put forward fast algorithm of the orthogonal wavelet transform that is Mallat tower-type algorithm [8].

Multi-resolution analysis is that signal C_0 was stepwise decomposed in two orthogonal space of the $L^2(R)$, and per step input was decomposed for high-frequency details signal and low-frequency approximate signal, and the sampling frequency of output was halved. The formula of this algorithm is:

$$c_{j+1,k} = \sum_k g(m-2k)C_{j,m} \quad (2)$$

$$d_{j+1,k} = \sum_k h(m-2k)C_{j,m} \quad (3)$$

Where, $c_{j+1,k}$ is approximate output when the signal is in the $j+1$ step, and $d_{j+1,k}$ is output when the signal is in the $j+1$ step. Two-scale sequence $\{g(k)\}$ is regarded as the coefficients of the low-pass filter, and $\{h(k)\}$ is the coefficients of the high-pass filter, the whole process gets a group of multi-rate filter signal reconstruction formula of Mallat is:

$$C_{j+1,k} = \sum_k c_{j,k} g(m-2k) + \sum_k d_{j,k} h(m-2k) \quad (4)$$

Through continuous compute the formula (3), we can obtain the original signal C_0

2.2 LMS Adaptive Filtering Algorithm

In this paper, using transversal structure of the LMS adaptive filter, LMS adaptive transversal filter is composed of two basic components: (1) it has transversal filter of the adjustable weights, when time is n , this set of weights was shown with, $\omega_1, \omega_2, \dots, \omega_M(n)$; (2) it adopt the weight adjustment mechanism of the LMS adaptive algorithm LMS adaptive transversal filter is closed system, its weight vector with the input data and output signals are related.

In $x(n)$ is weak signal when time is n , the input vector is:

$$X(n) = [x(n), x(n-1), \dots, x(n-M+1)]^T \quad (5)$$

Filter parameter vector is:

$$W(n) = [w_1(n), w_2(n), \dots, w_M(n)]^T \quad (6)$$

Filter output is:

$$Y(n) = \sum_{i=1}^m w_i(n)x(n-i+1) = W^T(n)X(n) = X^T(n)W(n) \quad (7)$$

Error $e(n)$ which is $y(n)$ relative to the desired output $d(n)$ of the filter was shown as:

$$e(n) = d(n) - y(n) = d(n) - W^T(n)X(n) \quad (8)$$

Using least mean square (LMS) algorithm, finding the optimal filter weights, and to improve detection signal. Output mean square error of filter is:

$$E[e^2(n)] = E[d^2(n)] - 2P^T W + W^T R_x W \quad (9)$$

In this paper, the minimum mean square error (LMS) algorithm was adopted; the iteration formula is as follows:

$$W(n+1) = W(n) - 2\mu e(n)X(n) \quad (10)$$

Where, $W(n+1)$ is the adaptive filter weight vector at $n+1$ time, μ is physical quantity which describes speed of the iterations,

2.3 Adaptive Filtering Algorithm of wavelet transform

When a weak signal with noise has wide frequency, the traditional adaptive filtering algorithm has some shortcomings which are not easy to obtain the optimal step size and the effect of filtering is unsatisfactory, combined with the advantages of wavelet decomposition, designing an adaptive filtering algorithm of wavelet decomposition, the block diagram of algorithm is shown in figure 2.

For a weak signal collected with noise, firstly, setting the parameters of wavelet decomposition (wavelet function, decomposition layers), the signal is conducted in multi-scale wavelet decomposition, and the signal of different frequency band can be got, including low frequency signal $C_{n,k}$ and high frequency signal $d_{1k}, d_{2k}, \dots, d_{nk}$. Through adjusting the parameters of every filter, the decomposed signal is conducted in adaptive filtering in order to reach the optimal effect of filtering. And when all the signal in the frequency bands meet the filtering requirements, the adaptive filtering comes to the end. the signal filtered is conducted wavelet synthesis, and finally the

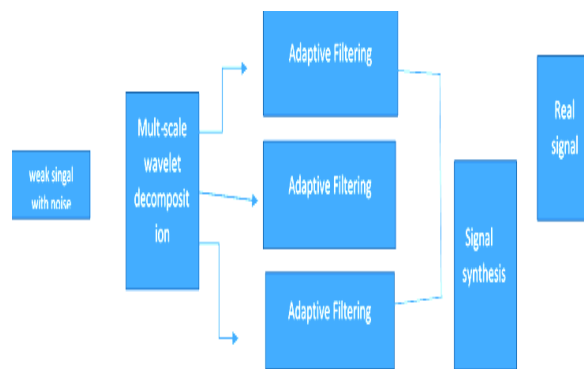


Fig. 1 Adaptive filtering algorithm diagram of wavelet decomposition

3. Adaptive filtering algorithm of wavelet transform in the application of weak signal detection

In the practical engineering, echo signal is weak it's extremely easily affected by various noise. The traditional adaptive filtering algorithm fails to set parameters easily, and it is not conducive to extract weak signal, which is extremely unfavorable in engineering practice. In this case adaptive filtering algorithm of wavelet transform is applied in the engineering practice.

Although the weak signal is susceptible to noise interference, the spectrum distribution of signal and noise are obvious difference. The frequency of weak signal is low, and the main effect of noise is in the high frequency band, so using this difference in frequency distribution to separate them by wavelet transform. Through using the wavelet multi-scale decomposition, weak signal is decomposed into the detail components and the approximation components in different scales and then using the adaptive filtering algorithm to filter for signal on the each scale, at the last, the signal, which is filtered on each scale, is needed to be synthesized, then we can get the useful signal. This method will not lose useful information about weak signal, which can accurately and efficiently extract weak signal from the noisy signal.

4. Simulation and analyze

In the simulation, we use original signal which is $s = x_s + x_n = 3 * \sin(0.5 * t) + x_n$, where x_n is interference noise. Vibration signal and current signal are separately shown in the figure 2 and figure 3. We can see weak signal was seriously interfered by white noise, which can produce serious impact on the practical engineering.

Using the traditional adaptive filtering algorithm and the adaptive filtering algorithm of wavelet transform to detect weak signal, the result to detect weak signal, the result are shown in the figure 4 and the figure 5 analyzing the result show that when using the traditional adaptive filtering algorithm for weak signal detection, the wave is rough and many noises fail to be filtered, but using adaptive filtering algorithm of wavelet transform for weak signal detection the wave is very good.

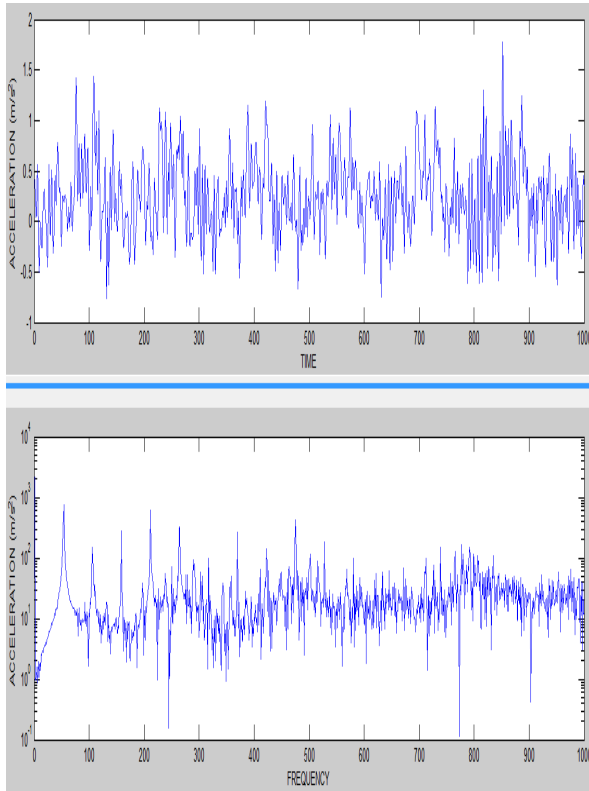


Fig.2 vibration signal with noise

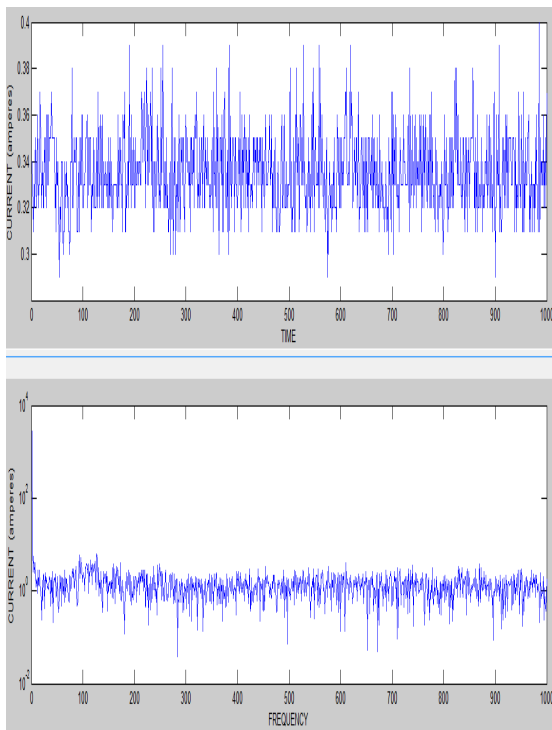


Fig.3 Current signal with noise

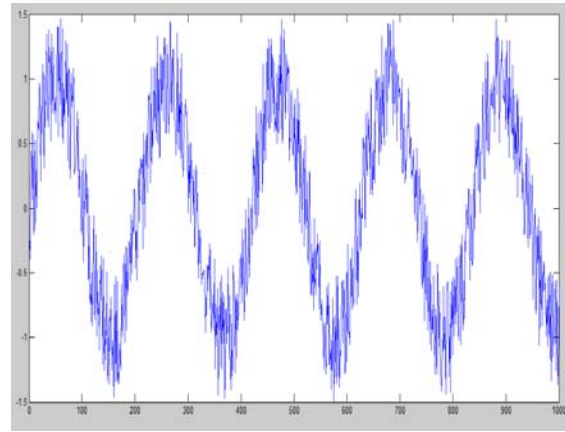


Fig.4 Traditional adaptive filter algorithm

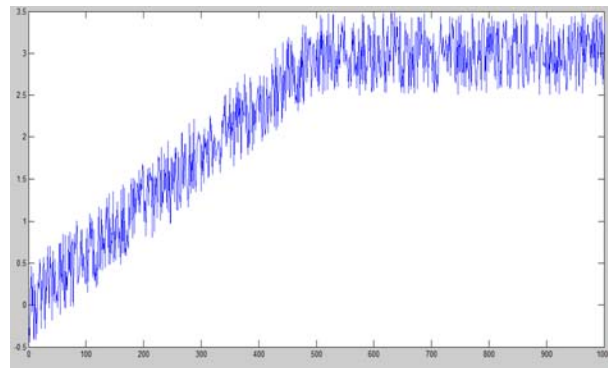


Fig 5 Adaptive filtering algorithm

5. Conclusion

The paper aims at the shortage of the traditional adaptive filtering algorithm and proposes adaptive filtering algorithm of wavelet transform, using this method to detect weak signal (vibration signal and current signal). The traditional adaptive algorithm and adaptive filtering algorithm of wavelet transform were compared and simulated by using the MATLAB software, the result show that the effect is better based on adaptive filtering algorithm in filtering noise and adaptive filtering algorithm of wavelet transform can greatly improve the weak signal to noise ratio, we can obtain , we can obtain a more good convergence speed and stability , so the performance of the traditional adaptive LMS algorithm was improved . The algorithm for weak signal detection provides a good way

6. REFERENCES

[1] S. Chen, B. Mulgrew, and P. M. Grant, “A clustering technique for digital communications channel equalization using radial basis function networks,” IEEE Trans.

- on Neural Networks, vol. 4, pp. 570-578, July 1993.
- [2] J. U. Duncombe, "Infrared navigation—Part I: An assessment of feasibility," IEEE Trans. Electron Devices, vol. ED-11, pp. 34-39, Jan. 1959.
- [3] TANG jian-feng,ZHANG Deng-yu,LUO Xiang-nan A new adaptive filtering algorithm based on multi-scale wavelet transform, Communication Technology, Vol 42,2008,p. 405-407
- [4] Pan Quan Meng jin-li, Zhang lei, cheng yong-mei,zhang hong-cai Wavelet Filtering method and its Application,Journal of Electronics and Information Technology,vol.29,2007;p. 237-22
- [5] LIU Li-feng ZHANG Qiu-song weak sound signal detection based on adaptive filter,microcomputer Informaion,2009,p84-85

FEMALE EXPLOITATION: A STUDY OF MANJU KAPUR'S DIFFICULT DAUGHTERS

J.P. Singh¹, Rashmi Dwivedi²

¹Assistant Professor, Dept. of English, Dr. B.S. Govt. College, Gwalior (M.P)

²Research Scholar, Jiwaji University Gwalior (M.P)

Email: jpsingh.1010@gmail.com¹

Abstract

Women writers like Manju Kapur, Kamala Markandaya, Gita Hariharan and Arundhati Roy have dealt with the gender issues disturbing women and presented women fighting against male chauvinism and domination of the patriarchal system. The present paper highlights the thesis and anti-thesis of feminine sensibility in Manju Kapur's novel *Difficult Daughters*. The novelist has focused on women characters that raise female anxiety due to the feelings of courage and determination. Kapur has brought into light the female class of 1940's when woman had no right to assert her identity.

Keywords: Patriarchal system, Identity Crisis, Thesis and Anti-thesis, feminine sensibility

Feminism in Indian English novel is a very sublime concept. However, feminism seems to refer to an intense awareness of identity. The exploitation of woman is a well known fact even recognized by History. Einstein interprets the term feminism as, "In my understanding the term 'feminist' then I see an element of visionary futurist thoughts. This encompasses a concept of social transformation that as part of the eventual liberation of women with change all human relationships for the better. Although centrally about women, their experience and condition. Feminism is also fundamentally about men and about social change."¹ Suma Chitnis has described the distinctive feature of feminist movement in India:

The most distinctive feature of this movement is that it was initiated by man. It was only towards the end of the century the women joined the fray. The list of who champion the cause of women is long- Raja Ram Mohan Roy, Ishwarachandra Vidyasagar, Keshav Chandra Sen, Matahari Phule, Agarkar, Ranade, Karve to mention a few. They record of the reform they undertook to achieve is impressive. It reveals that their efforts

spanned action to abolish the practice of Sati, the custom of child marriage, custom of distinguishing widows, the ban on remarriage of the upper caste Hindu Widows and a lots of other evil practices that affected women.²

A plethora of Indian Female writers have tried to depict the female exploitation and suffering of women in the male dominated society. Manju Kapur, Shashi Deshpande, Arundhati Roy and Gita Hariharan are prominent writers occupying rank with other Indian female writers who have expressed their feelings in the form of fiction and exposed the harsh and bitter realities of female psyche. Manju Kapur's novel *Difficult Daughters*³ (1999), focuses on sturdy self-assured women characters who raise anxiety and show courage and determination to apprehend their goals in life. This paper is an attempt to reveal profound insight of female's inner conflict and carve a way out of the dilemma in order to find an amicable solution. Women have been lagging behind in world literature for centuries. On the one hand, there are examples of Sita, Gargi, Rani Laxmi Bai and others who have followed their own paths but on the other if one

violates the traditional norms, one is subjected to bitter criticism by the society.

Manju Kapur has realistically depicted the female consciousness in *Difficult Dughters* and tried to show the struggle a woman has to do in order to prove her identity in the male dominated society. Virmati, the protagonist in *Difficult Daughters* struggles hard for her existential identity in adverse circumstances. The novelist has woven into text the story of three generations of the family in order to bring to fore the female exploitation not only by the male members but even by the female members. Tennyson's famous lines are applicable in the context, "old order changeth yielding place to new and God fulfils himself in many ways lest one good system should corrupt the world" (In Memoriam). Ida, the daughter of Virmati, belongs to the modern advanced generation. She goes to the native place of her mother in order to find out the real circumstances and happenings related to the life of her mother. Virmati comes in contact with Professor Harish who has returned to India to fulfill the desire of his mother to stay with the family, "His heart he had left in England, returning to India reluctantly, and only because of his mother's insistent demands" (36). Here one can very well assess the position of Professor's wife who is illiterate: "It had also been five years since he had seen his wife, but his wife had been in no position to enforce her claims" (36). He falls in love with Virmati at first sight when he meets her:

The Professor drank in the symbolism of her posture greedily. It moved him so deeply that he remembered it in all its detail even when his children had grown up. The murmur and rustle of students with scratching pens, their heads receding in rows, the whirr and the click-click of the fans overhead, and the stillness at the heart of it, enclosing him and Virmati, Virmati with her offering eyes in her open face.(47)

Virmati finds herself in no position to reveal her love for Professor to the family members who fix her marriage with an engineer: it seemed to Virmati that her family could talk of nothing else but her wedding. Every word they said had so little relation to her inner life that she felt fraudulent evening listening to them, passively, immorally silent"(70). The woman has to undergo pain and torture in order to tackle the peculiar situation. But the norms of patriarchal

social system do not allow her to expose her feelings of love in order to select a suitable man for her as her life partner.

Struggle yields results in life if it is pursued with firm conviction to achieve the desired goal. As a result of Virmati's keen desire for higher studies in Lahore, her cousin Shakuntala plays a pivotal role and proves herself to be the real mentor ; "Shakuntala's visit planted the seeds of aspiration in Virmati" (19). She intends to go to Lahore for higher education 'even if she had to fight her mother who was so sure that her education was practically over' (19). The old fashioned mother Kasturi represents the generation that follows the fundamental dictum of society and is ready to sacrifice her daughter at the altar of marriage for good reputation and attach little importance to education of a girl:

'Mati, please, I want to study...' Virmati faltered.

'But you have studied. What else is left?'

'In Lahore...I want to go to Lahore....'

Kastur could bear her daughter's foolishness no further. She grabbed her by the hair and banged her head against the wall.

May be this will knock some sense into you! She cried. 'What crimes did I commit in my last life that I should be cursed with a daughter like you in this one?'(59)

This is how a woman stands against her daughter and forces her for marriage, 'Remember you are going to be married next month, if I have to swallow poison to make you do it!(60). Mother's only concern is her daughter's marriage. Kasturi herself has meted out the same harsh treatment at the hands of her mother when she is 'caught praying to a picture of Christ'. The fundamentalism of society can be observed in the reference of a mother to a daughter 'But this witch sitting at home will have nothing better to do than think she is a Christian. Who will marry her then, I would like to know'.(61) During Kasturi's formal education, marriage is the only aim of her parents while educating their daughter in a missionary school of Punjab. Virmati's firm determination for getting higher education becomes fruitful after she goes to drown herself in a bid of frustration and disillusionment. The family members realize the need of the hour and send her to Lahore in the company of her cousin

Shakuntala who has been a source of inspiration for her by extending her a helping hand in critical moments of Virmati's life:

'You will find Viru that in Lahore people are not so narrow-minded. It is a pity the man was married, but you have done the right thing. Together we will face the family. After all I have experience in resisting pressures. Don't worry I am on your side.' (115)

The family plays crucial role in many ways in the development or fall of a female. Virmati's family especially her mother behave rudely and confine her to a go down of the house like an animal in order to keep her away from the matrimonial ceremony of her sister's marriage. She is compelled to leave the house for the sake of her freedom and education in Lahore. Ida, Virmati's daughter represents modern woman that does not follow the traditional path blindly but chooses the rational approach to discover reality behind her mother's troublesome past. She is keen to visit the place where her mother 'was educated after so much trouble' in order to know the reality about her mother's past life:

I want to see the place that had been the Mecca for all Punjabis. Lahore, where students gathered on the river, around the mausoleums, through the mall, in the gardens, the shopping areas, the eating places, the theatres. Where anybody with their brains went to study. To learn, to meet people, hear leaders, be in contact with social, political, fashionable trends. The centre of Punjab, its heart and soul, and how much else besides.(137)

Sense of emotional attachment to a man is a female's quality. Virmati's miserable plight is that she is in a fix to assess her real condition after being secretly married to Harish, the Professor in Lahore:

But when Harish is here I stop thinking of other things. And when he is not here, all I do is to wait for him to come. How long do we have to be secret man and wife, hidden from the eyes of the world? I hate it, but what can I do? (140)

Manju Kapur has put forth the predicament of a woman in peculiar circumstances imposed by patriarchal system of society. Virmati finds herself in difficulty to articulate her feelings. She can't discuss about the relationship with her roommate Swarn Lata: "In a dim obscure way,

Virmati longed for that open-hearted conversation between friends that relieved the mind, and strengthened faith in one self, but she had always found it difficult to articulate her feeling."(141)

Virmati's friend Swarn Lata reminds women of their duty for the country in times of struggle:

As women' it is our duty, no, not duty, that word has unpleasant connotations. It is our privilege to give ourselves to the unity of our country. Not only to the unity between rich and poor, but between Muslim and Hindu, between Sikh and Christian. Artificial barriers have been created amongst us to gain power over insecure and fearful minds. (145)

Virmati's life moves to and fro like a wheel as time and fate play crucial roles in her life and she becomes the victim of adverse circumstances even after going to Lahore for her bright future. She can't spend money for the newspaper 'if I start spending one anna on the newspaper, my mother will kill me'.(146) On the other hand, her roommate Swarna Lata does not prove to be a good companion in the hostel 'In her heart, she despises me, but we are living together, she has to pretend'.(147) She is ready to face any untoward happening in her life instead of going back to her parents in Amritsar even when the doctor prescribes medicines for her weak liver and fever. She somehow or the other wants to remain away from her family and equests the hostel authorities:

She begged them not or disturbs her parents, she was sure she would get well soon. Privately she hid the medicine; she didn't want any drugs suppressing her symptoms. Let it all come out. Nature cure was what her family believed in, and she had never in her life taken anything remotely resembling a pill. She drank lots of water to wash away the fever. (147)

Social barriers cause suppression in man-woman relationship. The Professor makes extramarital relationship with Virmati out of his deep love for her but the society in the form of wife, mother, and sister doesn't allow converting this relationship into marriage. And a girl has to undergo much humiliation and face difficulties more than a boy due to patriarchal structure of society. Virmati realistically puts her real picture before her lover:

I break my engagement because of you, blacken my family's name, am locked up inside my house, get sent to Lahore because no one knows what to do with me. Here I am in the position of being your secret wife, full of shame, wondering what people will say if they find out, not being able to live in peace, study in peace and why.....(149)

It is marriage which matters for a girl like Virmati who is not in a position to understand the real factor behind the excuse of delay in marriage ceremony. Indian social barriers and legal parameters don't permit a man to marry many times. After her involvement with Harish, Virmati realizes the fact that he wants to 'prolong the situation' of marriage. Here is the realistic portraiture of a married man falling in love with the other:

How do you know of them Viru? I come to you as a haven. Except for this, my life is hell! Hell! Tantrums, sulks, sly accusations. (149-50)

The very reality of her lover's behavior is just like 'an act of treachery' for a girl who has not taken care of her parents and stood against the system with the hope of her marriage to her lover.

Manju Kapur focuses our attention to the fact of fast changing scenario from the view point of women when they can participate even in the freedom struggle and the activities like education for the sake of their better future.

To conclude, Manju Kapur has vividly presented the life of women struggling against the patriarchal system of society in order to claim her right place. The novel is rather a story of a woman's continuous struggle for her existential identity against the perception of domesticity. The novel is the miserable tale of a woman torn between her family responsibility, the passion for education and her illicit love.

REFERENCES

1. Einstein, 'Feminist Criticisms and Social Change: Class and Race in Literature and Culture', Cambridge University Press, London, 1963.p.58.

2. Chitnis, Suma 'Alphabet of Lust', Kenyan Review, Vol.VIII, 1951.
3. Kapur, Manju. *Difficult Daughters*. London: Faber and Faber Limited, 1998.

CHALLENGES WITH UNSTRUCTURED BIG DATA ANALYSIS USING MACHINE LEARNING APPROACH: A REVIEW

Devendra Kumar Mishra

Assistant Professor, Dept. of CSE, ASET, Amity University (M.P)

Email:dkmishra@gwa.amity.edu

Abstract

Big Data contains large-volume, complex, growing data sets with multiple, sources. With the fast development of networking, data storage, and the data collection capacity, Big Data are now rapidly expanding in all science and engineering domains. The unstructured data files have text and multimedia content, E-mail messages, videos, photos, audio files, presentations, web pages and various other types of business documents. This data is growing at an unprecedented pace. Unstructured data is so valuable, however, organizations are trying to find out efficient ways to extract meaning of it that can translate it into connections and patterns. With the variety, speed and volume of data flowing through agencies' databases, it has become more and more difficult to find patterns that lead to meaningful conclusions. At the same time, agencies need to find ways to make sense of all of this data. While rules-based analytics tools like business intelligence where conclusions are generated based on preset business rules, these systems are limited by their very rules. The rules are set by humans, so they are limited by the way they are designed and directed. They also aren't set up to deal with the volume and variety of data available to agencies today. Gather the most value from large, disparate sets of information, both structured and unstructured, requires a newer approach. In this paper I am going to analyze the complexity associated with unstructured data and also describing machine learning approach that allows a system to analyze variables simultaneously, along with how they interconnect, to form patterns. It is well-suited to complex problems involving multiple variables, and does extremely well with large volumes of unstructured data including images, text, audio, sensor data and more. This approach helps organizations not only to discover patterns, but also to make more accurate predictions over time as it incorporates more data points.

Keywords: Big Data, Structure Data, Unstructured Data, Machine Learning

I. INTRODUCTION:-

Big data is a set of datasets which are so large and complex. Data sets are increasing day by day and transfer, sharing, storage, capturing of those data are the main challenges in Big Data. Data mining is a process of discovering patterns from a large data set. Big data contains the information that comes from various, autonomous and heterogeneous sources and have growing

relationships. There are different types of data like Relational Data, Semi-structured Data, Text Data, Streaming Data, Graph Data, etc. present in Big data. Data from various websites are growing with every second, so the data become large day by day. Social networking sites generate large amount of data. These data can be based on an event, on a particular topic, or usual contents. Twitter users convey their opinions in

the form of tweets. In a day, more than 600 million tweets are produced. The number of active members on Facebook on a day is around 800 million. The comments or posts produced by the number of users will be more than this. Apart from this there are a number of other sites available those are producing large amounts of data [1]. Online shopping sites can improve the brand, color, type and delivery locations of products from opinions. There is a vast amount of data available in Big data. Analyzing this amount of data and extracting information from it that may be useful for the organization for Market Analysis. The process of extracting the information or knowledge of the huge set of data is known as Data Mining. There are mechanisms to filter unwanted messages from the online social networking wall [2]. The ability to analyze, manage, visualize, summarize in scalable manner is a difficult task. Storing this amount of data without using it is simply a waste of storage space and time. Data should be processed to extract some useful information or knowledge from it.

II. UNSTRUCTURED BIG DATA

unstructured data is the opposite of structured data. Data typically existing in relational database is called structured data. It can be smoothly mapped into pre-designed fields. unstructured data is not relational and doesn't fit into these kinds of data models defined in prior. Frequently the unstructured data files comprise multimedia and text content. E-mail messages, videos documents forward processing, web pages, audio files, photos, presentations, and various other types of business documents can be considered as unstructured data.

For any organization 80 to 90 percent of the data comes under the category of unstructured data and the figure is continuously increasing. It is a common consideration among many establishments that their unstructured data stores include information that is likely to help them in making better business decisions.

When analyze social networking sites like Facebook, data are of different forms like images, text, relations, etc. One person will be associated to more than one person. These relationships can be represented as graphs. From these varied sources, the discovery and extraction of useful information will be difficult. Twitter also contains such information. Blogs and News sites are content based. So that large

amount of contents will be there to store. It is not possible to store such huge information on a single PC. It leads to enlarged storage and cost. Table 1 show the characteristics of unstructured Big data

Table-1: UNSTRUCTURE DATA CHARACTERISTICS

UNSTRUCTURE BIG DATA	
Complexity	High
Data Format	Different data Format
Mining	Difficult
Size	Large (growing)
Algorithms	Difficult to apply
Aggregation of data	Difficult

III. FRAMEWORK FOR UNSTRUCTURE DATA MINING

In Unstructure data we generally find text data. mining of text can be viewed as consisting of two phases: Text refining that transforms free-form text documents into a chosen intermediate form, and knowledge distillation that deduces patterns or knowledge from the intermediate form. Intermediate form can be semi-structured such as the conceptual graph representation, or structured such as the relational data representation.

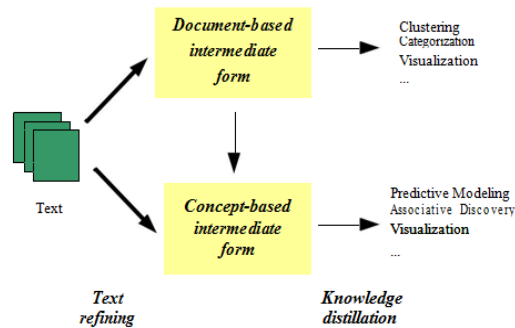


Figure 1

Figure 1 showing a mining framework for Text In this Text refining converts unstructured text documents into an intermediate form . that can

be document-based or concept-based. Knowledge distillation from a document-based intermediate form deduces patterns or knowledge across documents.[3]

IV. MACHINE LEARNING APPROACH

There are several area where we can apply Machine Learning approach, the most important of which is data mining. People are often making mistakes during analyses or, possibly, when trying to establish relationships between multiple features. This makes it difficult for them to find solutions to certain problems. Machine learning can often be successfully applied to these problems, improving the efficiency of systems and the designs of machines. The main focus will be on the two most commonly used ones — supervised and unsupervised learning. Supervised learning is tasked with learning a function from labeled training data in order to predict the value of any valid input. Common examples of supervised learning include recognizing handwriting, classifying email messages as spam, and labeling Web pages according to their type. Many algorithms are used to create supervised learners, the most common being neural networks, Support Vector Machines (SVMs), and Naive Bayes classifiers. Unsupervised learning, is tasked with making sense of data without any examples of what is correct or incorrect. It is most commonly used for clustering similar input into logical groups. It also can be used to reduce the number of dimensions in a data set in order to focus on only the most useful attributes, or to detect trends. Common approaches to unsupervised learning include k-Means, hierarchical clustering, and self-organizing maps[4][5].

In this paper, I have concentrated on the supervised machine learning approaches only. Table 2 compare different supervised learning approach on parameter that are challenging to Big data.

Table:-2 Comparison between supervised learning approach

Parameter	Decision	Neural	Naïve	kN	SVM
-----------	----------	--------	-------	----	-----

	Trees	Netw orks	Bay es		
Accuracy in general	2	3	1	2	4
Speed of classification	4	4	4	1	4
Dealing with discrete/binary/continuous attributes	4	3	3	3	2
Dealing with danger of overfitting interdependent attributes	2	1	3	3	2
Explanation ability/transparency of knowledge/classifications	4	1	4	2	1
Model parameter handling	3	1	4	3	1
Tolerance to redundant attributes	2	2	1	2	3
Attempts for incremental learning	2	3	4	4	2
Tolerance to noise	2	2	3	1	2
Speed of learning	3	1	4	4	1

Where 4 shows best and 1 shows poor

V.CONCLUSION

This paper present different supervised machine learning approach with the parameter that are challenges in case of Big data. if data are unstructured then complexity increase more and more. The key question arise when dealing with Machine Learning approach that which learning algorithm is superior to others, but under which conditions a particular method can significantly outperform others on a given application problem. After analyze the strengths and limitations of each method, we can integrated two or more algorithms together to solve a problem . The objective is to utilize the strengthes of one method to complement the weaknesses of another.

REFERENCES

- [1] Chau, Michael, and Hsinchun Chen. "A machine learning approach to web page filtering using content and structure analysis." *Decision Support Systems* 44, no. 2 (2008): 482-494
- [2] Vanetti, Marco, Elisabetta Binaghi, Elena Ferrari, Barbara Carminati, and Moreno Carullo. "A System to Filter Unwanted Messages from OSN User Walls." *Knowledge and Data Engineering, IEEE Transactions on* 25, no. 2 (2013): 285-297.
- [3] Hearst, M. A. (1997) Text data mining: issues, techniques, and the relationship to information access. Presentation notes for UW/MS workshop on data mining, July 1997.
- [4] S. B. Kotsiantis" Supervised Machine Learning: A Review of Classification Techniques" *Informatica* 31 (2007) 249-268 .
- [5] Jiang Zheng, Aldo Dagnino "An Initial Study of Predictive Machine Learning Analytics on Large Volumes of Historical Data for Power System Applications " *IEEE International Conference on Big Data* 2014

COMPONENTS DESIGN OF HOISTING MECHANISM OF 5 TONNE EOT CRANE

Pooran Singh Dhakar¹, S.G.Mishra², K.C.Arora³

¹PG Scholar, (Machine Design), IPS-CTM, Gwalior (M.P)

²Associate Professor, Dept. of Mechanical Engg., IPS-CTM, Gwalior (M.P)

³Professor, Dept. of Mechanical Engg, NITM, Gwalior (M.P.)

Email: psdhakar123@gmail.com¹, shatrughan11@gmail.com², kcaroranitm@gmail.com³

Abstract

In modern days Electric Overhead Travelling crane is very important material handling equipment in industry because of safety, reliability, economy, fast speed etc. Most of industries are using EOT cranes for handling of material, EOT cranes are available in many load carrying capacities, 5 tonne EOT crane is mostly used in industries. Following are components of hoisting mechanism in EOT crane such as crane hook, thrust ball bearing, pulley, wire rope, drum, gear box, electric motor brake etc. In this paper we have designed these components for 5 tonne crane. Same procedure can be used for heavy load cranes.

Keywords: Overhead Crane, Crane Hook, Thrust ball bearing, Pulley, Wire rope, Drum, Gear box, Electric motor, Brake.

I. INTRODUCTION

The crane is one of the most important equipment for handling of material in any industries with fast speed, reliability, safety, economy etc. so crane is used. EOT crane is a mechanical lifting device used for lifting or lowering the material and also used for moving the loads horizontally or vertically. It is useful when lifting or moving the loads is beyond the capacity of human.

Applications of material handling device like crane is a prime consideration in the construction industry for the movement of material, in the manufacturing industry for the assembling of heavy equipment, in the transport industry for the loading and unloading and in shipping etc. This device increase output, improve quality, speed up the deliveries and therefore, decrease the cost of production. The utility of this device has further been increased due to increase in labour costs and problems related to labour management.

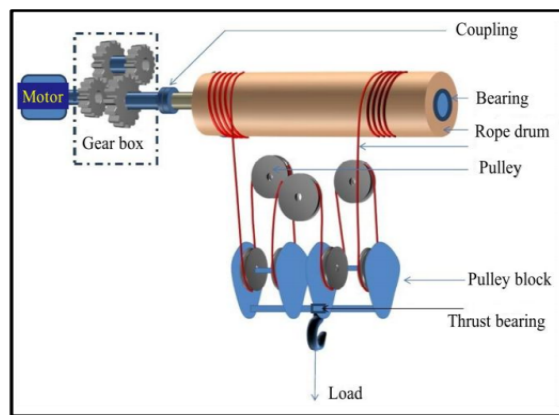
Crane is a combination of separate hoisting mechanism with a frame for lifting or a combination of lifting and moving load. There is

very much useful to pick up a load at one point and be able to transport the object from one place to another place to increase human comfort. There are three major considerations in the design of cranes. First, the crane must be able to lift the weight of the load. Second, the crane must not topple. Third, the crane must not rupture.

The cranes are available in so many types of such as Jib crane, Tower crane, Truck mounted crane, EOT crane, Telescopic crane, Gantry crane, Aerial crane, stocker crane, etc. Here, discuss about Electric Overhead Travelling (EOT) crane. EOT crane is also known as bridge crane. Electric Overhead cranes typically consist of either a single girder or a double girder construction.

Generally an Overhead crane show three motions-

1. Long travel
2. Cross Travel
3. Hoisting (up & down)



(Fig. hoisting Mechanism of EOT Crane)

II. LITERATURE REVIEW

A. Indian Standard (807-2006) [1]:

This standard describes design of structural portion for cranes, hoists, specifics permissible stresses and other details of design. In order to ensure economy in design in reliability in operation. To deal with the subject conventionally, cranes have been broadly classified into eight categories based on their nature of duty and number of hours in service per year. It is producers or manufactures responsibility to ensure the correct classification.

B. Indian Standard (3177-1999) [2]:

Indian standards are broader in concept and give a standard principle in a generalized form because of uniformity of a product or services. This standard covers the mechanical and electrical drives of the cranes. The components of crane are made with dimensions or design in accordance with the help of Indian standard. IS-3177-1999 covers all selection criteria of components in EOT crane such as lifting hooks, shaft, wire rope, rope drum, flanges, sheaves, bearings, gear boxes, couplings, fasteners, motor, etc.

C. Rajendra Parmanik [3]:

Rajendra parmanik in a post “Design of hoist arrangement of EOT crane” (2008), he has discussed about the history of crane, various types of crane, application, the design of the hoist of EOT crane is done by algebraic calculation and a model design of the various parts of EOT crane.

D. Dr. Frank Jauch [4]:

Dr. Frank Jauch in a post “care, use and maintenance of wire ropes on cranes”, he has

discussed about drum. There are two types of drum: single layer drum and multi layer drum, both are used based on lifting capacity of an object. He has also discussed about crane ropes.

E. Pradyumnakesharimaharana [5]:

Pradyumnakesharimaharana, in the thesis “Computer Aided Analysis and design of hoisting mechanism of an EOT crane”(2012), states that wire rope is liable component in crane and failure due to large amount of stresses. So increase the number of rope falls decrease the tension on rope falls and also used factor of safety.

Ultimately reduce the risk of wire rope failure, increase number of rope falls so increase length of wire rope which is expensive. The arrangement of wire rope is also important and arrange in between upper pulley block and bottom pulley block.

(Fig.for 5 tonne)

He has been found various cross section of shape crane hook and calculated stress and deflection at critical points using ANSYS. So conclude that trapezoidal section show less stress. Also calculated rating of motor, brakes used in hoist mechanism. Motor power required depends on lifting speed and load applied.

III. DESIGN PROCEDURE

List of components used in Hoisting Mechanism of EOT Crane Design-

1. Crane Hook
2. Thrust ball bearing
3. Pulley
4. Wire rope
5. Drum
6. Gear box
7. Electric motor
8. Brake

1. DESIGN OF CRANE HOOK

In this phase basic dimensions for crane hook are calculated like bed diameter, throat diameter, depth of crane hook. In this study trapezoidal type cross-section are considered.

The hooks are tested to more than double the working load, and for this reason their strength need not be investigated ordinarily. Analysis of the stresses in the hook, which is a curved bar subjected to combined bending and tensile stresses is a matter of some complexity.

The most suitable practical section for the body of the shank hook approximates the triangular or trapezoidal form with the proportions.

Hook bed diameter is given by the formula,
 $C = \mu \sqrt{P}$

Where P is the load applied in tonne & μ is a constant varying from 3.75 to 7.5

For economy of material, the value of μ should be kept as low as possible, the lower limit being fixed by the size of slings, ring etc. to be accommodated. In shank hooks using metal fittings, μ has been fixed at 3.75.

For 5 Tonne Hook, $C = 3.75 \sqrt{5}$
 $= 8.385 \text{ cm}$

This relation between C and d for the recommended standard section is

$d = 3.125 \sqrt{P} + 0.1$ $C = 3.125 \sqrt{5} + 0.1 \times 8.385$
 $= 7.8275 \text{ cm} = 7.8 \text{ cm}$

This value of d will be at the horizontal and vertical centre lines of the hook, whilst at a plane mid way between these (say at 45° to the horizontal), a section having a value of d some 8% greater is used. In this case, a value of $78 \times 1.08 = 8.5 \text{ cm}$ is attained. As the body curves to join the shank, the section may be reduced provided that the reduction does not cause the maximum stress to exceed a specified value.

The working tensile stress in the shank may be assumed at 400 kgf/cm^2 as recommended by some authors.

Let $d^1 = \text{Dia. Of shank at bottom of the threads.}$

Then, $0.785 (d^1)^2 \times 400 = 500$

$(d^1)^2 = 16$, $d^1 = 4 \text{ cm}$

The hook load will be carried by a thrust bearing through a round nut screwed on to the end of the shank.

Full dia. Of the shank = $40/0.84 = 48 \text{ mm}$ say 50 mm

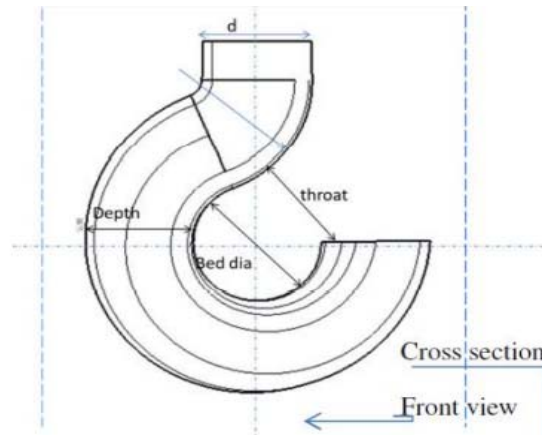
The other dimensions of triangular (or trapezoidal as it is called) section of the body of the hook can now be known.

Breadth at intrados = $0.65 \times 78 = 50.8$ say 51 mm

Radius of intrados curve = $0.75 \times 78 = 58 \text{ mm}$

Bed dia. = 84 mm

Corner radius = $78/8 = 10 \text{ mm}$



2. SELECTION OF THRUST BALL BEARING

The swiveling motion of the hook will be very slow and intermittent rather than the use of a ball bearing in such cases is only to prevent the spinning action of the load relative to the wire ropes. For this reason, the speed factor need not be taken into consideration.

It will show that a single thrust ball bearing type 51210 (50 mm bore) will be suitable here. The dimensions and load carrying capacity are as follows:-

Bore - 50 mm and 50.2 mm

Outside diameter - 78 mm

Thickness - 22 mm

Static carrying capacity - 9000 kg

Factor of Safety = $9000/5000 = 1.8$

3. DESIGN OF ROPE PULLEYS

For 6/37 construction of the wire ropes the minimum dia. Of rope pulley at the bottom of the v-groove as recommended by IS-2266-1963, should be 6 times the circumference of the rope.

On this assumption, the P.C. dia. Of rope pulley should be $6 \times 4.4 = 26.4$, say 27 cm or 270 mm at the bottom of the groove say 285 mm rope crs (min.) adopt 290 mm dia.

The general design of the rope pulleys may now proceed.

As the dia. Of the pulley is 290 mm (rope crs) only a solid web with cored holes (to lighten the weight) and with lateral ribs for stiffening will be preferable.

One point that requires special investigation is the intensity of bearing pressure on the pulley pin. In this case the pulley boss acts as a bearing and is not fixed to the pin.

The bearing pressure on pulley pin should not exceed 18 kgf/cm².

Minimum projected area required for each pulley = $5250/(2 \times 78) = 33.65 \text{ cm}^2$

Both the pulley will have to be accommodated within a space of 118 mm (distance between the side plates), so that the boss length of each pulley should not exceed $(118-2)/2 = 58 \text{ mm}$.

4. SELECTION OF WIRE ROPE

The load will be on 4 falls; i.e. on two rope pulleys through the medium of an equalizing pulley or sheave fixed to the crab (trolley) frame.

Load per fall = $5000/4 = 1250 \text{ kg}$ plus 5% due to D.T. of Hook block = 1313 kg

A factor of safety of 8 (minimum) is usual in the design of electric overhead travelling cranes and hoists etc.

Breaking load of the wire rope should be $1313 \times 8 = 10500 \text{ kg}$ (approx.)

Three construction of wire rope are in most common use for the design of hoists etc. 6/19, 6/24 (with fiber), and 6/37 out of these three, 6/37 is preferable, being more flexible than the other two. Also to reduce the dia. Of rope pulleys to a minimum possible a superior grade of wire rope having a tensile breaking stress of 1725 to 1885 kgf/cm² will be adopted.

From IS: 2266 – 1963 a wire rope having a circumference of 44 mm (14 mm ra.) and having a tensile breaking stress of 1725 to 1825 kgf/cm² will have a guaranteed breaking load of 10900 kg.

Rope type	Brakeing load	Rope diameter In cm	Available dimension(in mm)	Weight of rope/10 m in kg	Effective area	Stress in a wire
6x7	4800d ²	2.71	29		51%	1.68tonne/14.39mm ² *116.74N/mm ²
6x19	5100d ²	2.63	29	29.210	50%	0.61tonne/6.39mm ² =95 N/mm ²
6x37	4800d ²	2.71	29	29.332	43%	0.37tonne/2.84 mm ² =130 N/mm ²
8x19	4400d ²	2.83	29	30.212		

5. DESIGN OF ROPE DRUM

The rope drum should be made of seamless pipe machined & grooved accurately, to -ensure proper seating of wire rope in a proper layer. The drum should be fitted with two heavy duty Ball / Roller bearings of reputed make for smooth operation & longer life.

Drum length = pitch x ground height x no of rope fall/drum dia = $35 \times 10000 \times 8 / 667 = 4197 \text{ mm}$

[let ground height be 10m]

Average drum thickness = $h+h/2 = 31.9+7.1/2 = 35$



6. SELECTION OF GEAR BOX

Totally enclosed oil splash lubricated & dust free gear box should be provided for smooth, trouble free & longer life. All gears are helical type and cut from alloy steel/ low carbon steel on hobbing machines for achieving higher precision & a special process of gear toughening ensures smooth, silent, trouble free running of drive system. The pinions and gears are supported on anti-friction bearings on both ends.

For drum rotating angular speed,
= w x lifting speed/diameter of the drum
= 0.184 radian/s

For motor let, w= 62.31 radian/s

Reduction in speed = 342 times

7. SELECTION OF ELECTRIC MOTOR

Hoist & crane duty hour rated squirrel cage induction motors, confirming to IS 325 with comparatively higher H.P. and higher starting torque to reduce handling time. It is flange mounted to suit the design and provided with suitable insulation

Lifting speed varies from = 10 to 26 f or 50.79 to 132.08 mm/sec.

Speed of drum = $4 \times 0.132 / R = 2N$

For drum rotating angular speed = w lifting speed/dia. Of the drum = 0.184 radian

Power transmitted by shaft = 2NT/60

Power = $4 \times 0.132 \times 50000 \times 6 = 158400 \text{ Watt} = 158.4 \text{ kW}$ [7]

8. SELECTION OF BRAKES

When selecting the proper brake for a specific application, there are several factors are consider; a few that need to be reviewed-

Brake torque, stopping time, deceleration rates, brake mounting, brake location, thermal rating, environment, brake style.

The brake systems manufactured external friction brakes.

Applications for which these brakes are suited can be classified into two general categories:- non-overhauling , overhauling.

A) Non-overhauling loads are typically horizontally moving masses such as crane bridges, crane trolleys, horizontal conveyors.

B) Overhauling loads tend to accelerate in speed if a brake is not present, examples of which are crane hoists, winches, lifts, and downhill conveyors.

Non-overhauling loads require brake torque only to stop the load and will remain at rest due to friction. Overhauling loads have two torque requirements; the first is braking torque required to stop the load, and the second is the torque required to hold the load at rest.

IV. CONCLUSION

Over 5 Tonne EOT crane provide more reliability, safety & speed comparison to other available crane because different components used to perform function. Generally, there is one rope drum, motor and gearbox used in hoisting mechanism. It means that only single drive mechanism is used for lifting purpose & displacement of over objects. In this paper I am also discuss all designing factor and factor of safety according to Indian Standard.

REFERENCES

- [1] S.N. Trikha “Machine Design Exercises” Edition 1973.
- [2] Indian standard Design, erection and testing (structural portion) of cranes and hoists code of practice (second revision), IS 807:2006.
- [3] Indian standard code of practice for EOT cranes and gantry cranes other than steel work cranes (second revision). IS 3177:1999.
- [4] Rajendra parmanik “Design of hoisting arrangement of EOT crane” posted on July 26, 2008.
- [5] Dhaval H. Kanjariya “A Review on Design and analysis of Hoisting Machinery in EOT Crane” review paper, 2015.

[6] Dr. Frank jauch, “care, use & Maintenance of Wire Ropes on Cranes”, Crane Industry Council of Australia (CICA) 2012.

[7] Pradyumnakesharimaharana, “Computer Aided Analysis and Design of hoisting mechanism of an EOT crane”, Mechanical Engineering Thesis 2012.

[8] PSG Design Data Book edition 2007.

DESIGN AND DEVELOPMENT OF ELECTRO-MAGNETIC SOLAR INTEGRATED SYSTEM ON HIGHWAYS

Burhan Pasha C S¹, Naseer Ahmed S N², Kiran T³, Jamsheer P T⁴

HMS Institute of Technology, Tumkur (Karnataka)

Email:¹burhancsen@gmail.com

Abstract

Demand for energy is an increasing criterion that all developing nations are facing today. Thus the scarcity of energy has to be satisfied for the healthy development of the nation. As the non-renewable sources are depleting day by day, the world is moving on the renewable sources to satisfy the peak demand value of energy. Hence we planned to utilize the wind energy impact generating on highways/expressways. When we stand aside of the road, we feel the impact of wind on us as the vehicle passes by us. . Similarly this wind impact energy can observe on the highways. However the wind impact is sheer on Highways as vehicles travelling at greater speed. Hence this impact of energy cannot be wasted; it has to be utilized to produce energy into other form, which can be easily consumable. For this we have designed a System which works on the principle of electro magnetism and solar energy, placed on the divider to generate electricity.

INTRODUCTION

India cost for wind turbines is greater than that of conventional fossil fuel generator per Mw installed. Noise is produced by rotor blades, so that wind farms have to build in the location where wind can be entrapped. Today we are adding 2000-3000Mw of renewable energy capacity every year. 12th five year plan targets 6000Mw annually and to meet our national action plan on climate change (NAPCC) target, we need more than 15000Mw every year. We all know that India is an energy deficit country and our per capita power consumption is 3rd of china and a 5th of US. There is a lot of latent demand and as India grows, our deficit-current estimated of 10% on installed base of 200Gw will likely go up if no new investment is made in power capacity and in improving distribution. We need to add generation capacity from as many source as possible renewable can help bridge this gap. It has shorter lead time for capacity creation and proximity to load centre. On keeping, prime focus on the crisis of three imperative components in the world like energy, food and water we have done an experimental investigation on the highways/expressways, so as to find the method that how these highways

can be used as a hub of generating electricity by harnessing the available energy in better efficient way. Two types of energy are available from wind flowing through these highways:-1) natural wind energy and 2) impact wind energy. But our experimental investigation is concentrated on behaviour or characteristics of impact wind energy, as lots of advanced research work has already been done or going on harnessing of natural wind energy.

Objectives: The aim of the project is to design an Electro Magnetic Solar Integrated (EMSI) system that is to be implemented on highways for energy production. It will generate energy by capturing the following things.1) Impact wind energy generated by vehicles on highways.2) Solar energy from the Sun.

Research

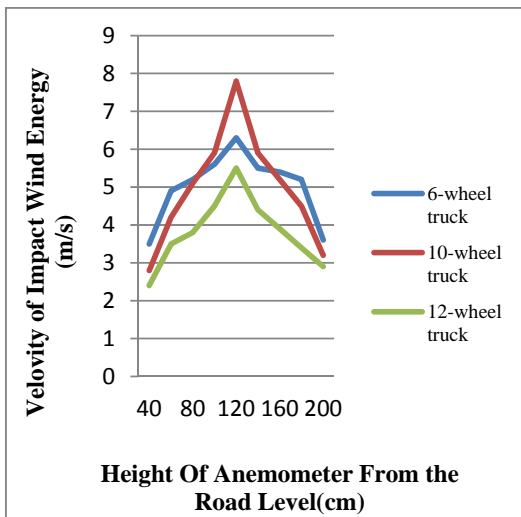
The process of development of the system involves following stages.

Stage 1: Determination of Wind impact in the form of Induced pressure through wind analysis

Wind Analysis: The project depends on the principle of Faraday's law of Electro-magnetic induction. Since the current can produce by the

movement of the magnet inside the coil or movement of the coil over the magnet. Hence in the project we used magnetic ball to move inside the copper coil placed in a pipe where the potential to move the ball is given by wind energy impacts produced on highways due to the movement of automobiles. To determine the wind impact on the EMSI system, wind analysis is necessary on a particular location. Since the major factor for the initiation of EMSI system is wind. The height takes an important role for wind impact on the system, as it is placed on the divider of highway. We used a wind analysis instrument- **Anemometer** for the analysis. The analysis is carried on the divider of highway, NH4 (National Highway) of Bangalore to Pune. The analysis involves different types of vehicle such as from 6, 10 and 12 wheel truck against difference in height of the anemometer placed on the divider.

The velocity of impact wind energy versus Height of the anemometer above the road level is represented in the following graph:



Analysis carried on the side of the divider of highway for different vehicles as shown in the figure:



As per the result of the graph, the peak value is at the height of 80~120cm above the road level and it goes on decreases when we increase the height above 120cm. Thus the optimum level of wind energy impact is in 80~120cm which is a suitable height to place the system above the level of the road. We also observed that, when automobiles move on Highways/expressways, there is a creation of **front and back pressure** column on both sides of the road. This pressure column difference is due to **imbalance of high pressure/low pressure energy band** created by automobiles. Due to this pressure band, wind flow creates the **pressure thrust**. The wind pressure thrust depends on different factors as follows; a) The intensity/frequency of the **traffic**; b)The **size** of the automobiles; d)The **speed** of the automobiles; e)**Distance** between the EMSI system and vehicles; f)**Angle** of impact; g)Velocity of **natural wind**.

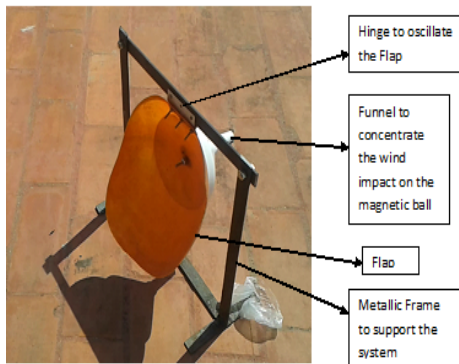
From the experimental investigation, by converting velocity of the wind impact to induced pressure, the amount of pressure can induced on the EMSI system at the height of 80~120cm shown in table below,

Sl. no.	Type of vehicles	Induced pressure (in gm.)	Induced Pressure (in N)
1	12-wheel truck	250	2.5
2	10 wheel truck	200	2
3	6 wheel truck	150	1.5

The result of the wind analysis is that, the highways can provide us a wind energy impact of about 1.5 to 2.5 N alternately depending on the type of automobile.

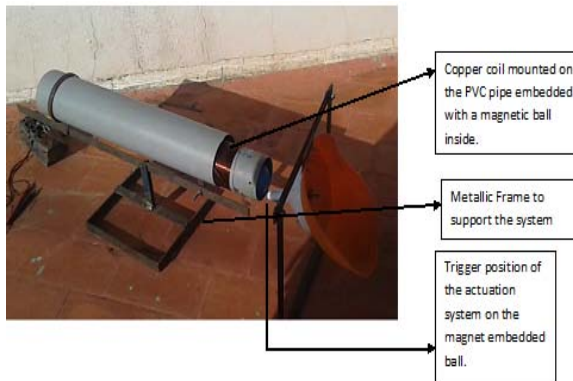
Stage 2: Actuation system

Conversion of energy is necessary to utilize the available wind impact energy to generate electricity. To bridge the gap between these energies the role of an actuation system is humongous. The actuation involves a trigger system which converts the wind impact to movement of the magnetic ball inside the coil. It includes locally available hinge, funnel and a waste plastic pot which is bisected in the form of a flap. The actuation system is shown below,



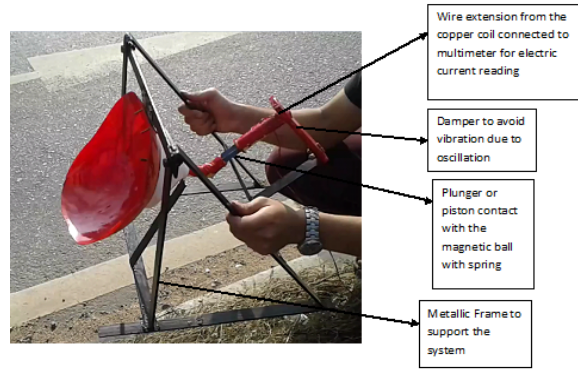
Stage 3: Development of flow path for magnetic ball followed by actuation system

The conversion according to Faraday's principle is achieved by incorporating copper coiled on a locally available waste PVC pipe around 2-3 feet, embedded with magnetic ball. The flow of energy of wind impact is triggered by the actuation system on the magnetic ball to allow it to cause to and fro motion inside the copper coil.



Stage 3: Alteration of the model to obtain efficiency

Since the Length of the pipe was huge, it was implausible to attain greater moment of magnetic ball. Hence the generated electric current was too small in the multimeter reading. It is also due to the indefinite clearance between the magnet and the coil. To increase the efficiency, we compact the model as one unit. This involves reduction in the dimension of the cylindrical pipe and the magnetic ball. Consequently, actuation system is connected with a plunger or piston for the definite movement of the magnet inside the coil. A spring is installed in the Cylinder for compression and extension which leads to oscillate the ball when impact generates.



Efficiency: The obtained Model undergone several iteration as explained above to increase the output required. The current generated as per the Multimeter reading is 0.2-0.45V. This can be increased by further refining the model such as increase in the number of turns in the coil, oscillation of Magnetic ball inside the coiled cylinder, etc. The surface area required is feasible due to its compatibility. The generated current can be stored in the battery and then it is utilized.

Integration of Solar energy: The efficiency can be further increased by integrating the model with Solar panel at the top. This modification is still in process. The dual energy can produce more electricity than alone. The whole EMSI system is Eco friendly i.e. it does not damage the plants grown on the divider of the highway.

Additional application

This mechanism or system which we have adopted is on highways. It can also be incorporated in Railways and other expressways with suitable design such as wind analysis, compatibility and design optimization.

Benefits: The system is based on the utilization of wind and solar energy which are renewable free source of energy. The electric current can be stored in batteries. The space utilization to install requires minimum area on the divider.

References:

- [1] C.J. Baker (1986), "Train Aerodynamic Forces and Moments from Moving Model experiments"
- [2] "A method for generating electricity by capturing tunnel induced winds"
- [3] K. Nandigan, B.H.Choudry "Power flow and stability models for induction generators used in wind turbines", IEEE Power Engineering Society General Meeting, Vol.2, 6-10 June 2004 Page: 2012-2016

OPTIMIZATION OF SURFACE ROUGHNESS OF A DRILLED HOLE ON SUP 11A BY TAGUCHI'S OPTIMIZATION TECHNIQUE

Premanand S. Chauhan¹, Ravi K. Dwivedi², Sudhir Sharma³

¹Prof., Dept. of Mechanical Engg., IPS-CTM, Gwalior (M.P)

²Associate Prof, Dept. of Mechanical Engg., MANIT, Bhopal(M.P)

³Asst.Prof, Dept. of Mechanical Engg., IPS-CTM, Gwalior, (M.P)

Email:prempunit@gmail.com¹, nitb.ravi@gmail.com², mechanical.sudhir@gmail.com³

Abstract

In this paper, an attempt has been made to optimize the surface roughness of a drilled hole in a leaf spring by *Taguchi's Optimization Technique*, to reduce the rejection which is taking place during the drilling operation while manufacturing of leaf spring. An orthogonal array, signal-to-noise (S/N) ratio and the analysis of variance (ANOVA) are employed to investigate the optimal drilling parameters of SUP 11A spring steel strip and HSS drilling bit. This paper will yield the optimal combination of drilling parameters which will provide the optimum surface roughness on the hole during the drilling process of the leaf spring. After implementing the optimum combination, the manufacturing non-conformities has been reduced 4.99% to 3.99% out of total production and 19.91 to 12.06% out of total non-conformities.

Keywords: ANOVA, SUP 11A, Surface roughness, S/N Ratio, Taguchi Method.

INTRODUCTION

A leaf spring is a beam of cantilever design used to absorb the shock loads. Mostly, used in passenger and commercial vehicles as a part of the suspension system that connects the wheel base and the chassis of high criticality in terms of safety of the vehicles. The advantage of leaf spring over helical spring is that the ends of the leaf spring may be guided along a definite path as it deflects to act as a structural member in addition to energy absorbing device [1]. A leaf spring is generally bent in an arc-shape and has a rectangular cross-section. It has holes drilled both at the centre as well as at the sides to accommodate the centre bolt and the U-clamps (for fixing the leaves) respectively(Fig.:1). the largest amount of money spent on any one class of cutting tools is spent on drills. Therefore, from the viewpoint of cost and productivity, modelling and optimization of drilling processes are extremely important for the manufacturing

industry [2]. Amongst traditional machining processes, drilling is one of the most important metal-cutting operations, comprising approximately 33% of all metal-cutting operations [3, 4].While drilling the holes, the combination of parameters should be such that the surface roughness remains the optimum, as the surface roughness of a machined product could affect the several functional attributes of the product, such as contact causing surface friction, wearing, light reflection, heat transmission, lubricant holding capacity and resisting fatigue. In this paper, Taguchi's Optimization Technique has been employed to determine the optimal combination of drilling parameters, so as to obtain the optimum surface roughness.

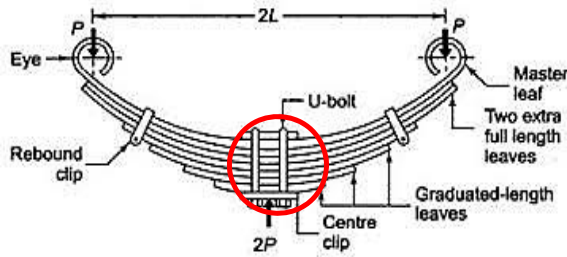


Fig. 1: Showing the position of Drilled Hole in a Leaf Spring.

Design of Experiment: Taguchi's Method

Dr. G. Taguchi of Nippon Telephones and Telegraph Company Japan is the developer of the Taguchi method [5], which involves reducing the variations in a process through robust design of experiments. He proposed that engineering optimization of a process or product should be carried out in a three-step approach, i.e. system design, parameter design, and tolerance design. In system design, the engineer applies scientific and engineering knowledge to produce a basic functional prototype design, this design including the product design stage and the process design stage. In the product design stage, the selection of materials, components, tentative product parameter values, etc., are involved. As to the process design stage, the analysis of processing sequences, the selections of production equipment, tentative process parameter values, etc., are involved. Since system design is an initial functional design, it may be far from optimum in terms of quality and cost. Following on from system design is parameter design. The objective of parameter design is to optimize the settings of the process parameter values for improving quality characteristics and to identify the product parameter values under the optimal process parameter values. In addition, it is expected that the optimal process parameter values obtained from parameter design are insensitive to variation in the environmental conditions and other noise factors. Finally, tolerance design is used to determine and analyze tolerances around the optimal settings recommend by the parameter design. Tolerance design is required if the reduced variation obtained by the parameter design does not meet the required performance, and involves tightening tolerances on the product parameters or process parameters for which variations result in a large negative influence on the required product performance. Typically, tightening tolerances means purchasing better-

grade materials, components, or machinery, which increases cost. However based on the above discussion, parameter design is the key step in the Taguchi method to achieving high quality without increasing cost[6]. This method for designing experiments investigates how different parameters affect the mean and variance of a process performance characteristic and defines how well the process is functioning. Product/process diagram [5]:

A Product/process diagram is used to indicate the various factors that influences of a Product/process. The figure 2 shows the various influencing factors of Product/process.

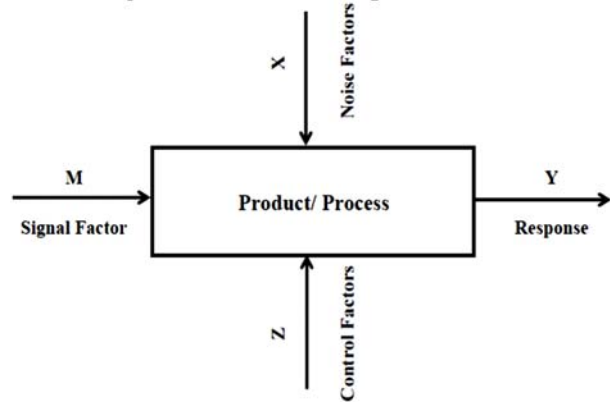


Fig.2: Product/process diagram

- The Signal Factor M consists of the input into the Product/Process, such as product design or Sequence of Processes.
- The Control Factors are those factors that can be controlled by the operator in order to obtain the required output. For Example: Speed, Cutter Radius, etc.
- The Noise Factors are the uncontrollable factors that influence the process to a great extent. They are responsible for the deviation of the output from the required output. For Example: Temperature, Humidity, Friction, Vibration, etc.
- Response is the outcome of the Product/process due to Signal Factor, changes in Control factor and Noise Factor.

Basically, experimental design methods [7] were developed originally by Fisher [8]. However, classical experimental design methods are too complex and not easy to use. Furthermore, a large number of experiments have to be carried out when the number of the process parameters increases. To solve this problem, the Taguchi method uses a special design of orthogonal arrays to study the entire parameter space with a

small number of experiments only [5]. As a result, time, cost, and labour saving can be achieved. Instead of having to test all possible combinations like the factorial design, the Taguchi method tested pairs of combinations in a more efficient way. This allows for the collection of necessary data to determine which factors most affect the product quality with a minimum amount of experimentation, thus saving time and resources. The Taguchi method is best used when there are an intermediate number of variables (3 to 50) [9], few interactions between variables and when only a few variables contribute significantly. The Taguchi's arrays can be derived or looked up. Small arrays can be drawn out manually; large arrays can be derived from deterministic algorithms. Generally, the arrays can be found online. The arrays are selected by the number of parameters (variables) and the number of levels (states). The experimental results are then transformed into a signal-to-noise (S/N) ratio. Taguchi recommends the use of the S/N ratio to measure the quality characteristics deviating from the desired values [10]. In the Taguchi method, the term 'signal' represents the desirable value (mean) for the output characteristic and the term 'noise' represents the undesirable value (standard deviation, SD) for the output characteristic. Therefore, the S/N ratio is the ratio of the mean to the SD. Taguchi uses the S/N ratio to measure the quality characteristic deviating from the desired value. There are several S/N ratios available, depending on the type of characteristic; lower is better (LB),

Factor	Parameters	Units	Level 1	Level 2	Level 3
A	Feed Rate	mm/rev	0.05	0.10	0.15
B	Speed	Rpm	325	450	850

nominal is best (NB), or higher is better (HB) [11]. Here, lower-the-better means lower the optimized value, better will be the results, higher-the-better means, higher the optimized value, better will be the results and nominal-the-better means, nominal the optimized value, better will be the results. A greater S/N ratio corresponds to better quality characteristics. Therefore, the optimal level of the process parameters was the level with the greatest S/N ratio [12]. The S/N ratio for each level of

parameters is computed based on the S/N analysis. In this case, lower-the-better criteria will be used, as it yields the optimal results. Furthermore, a statistical analysis of variance (ANOVA) is performed to see which process parameters are statistically significant. With the S/N and ANOVA analysis, the optimal combination of the process parameters can be predicted.

The parameter design of the Taguchi method includes the following steps [13]:

1. Identify the quality characteristics and process parameters to be evaluated.
2. Determine the number of levels for the process parameters and possible interactions between the process parameters.
3. Select the appropriate orthogonal array and assign the process parameters to the orthogonal array.
4. Conduct the experiments based on the arrangement of the orthogonal array.
5. Analyze the experimental results using the signal-to-noise ratio and statistical analysis of variance.
6. Select the optimal levels of process parameters.
7. Verify the optimal process parameters through a confirmation experiment.

Experimental Work

The drilling operation was carried out on a precision makeover Rockwell drilling machine. Here the feasible drilling parameters are feed rate (varying from 0.05 to 0.15 mm/rev) and speed (varying from 325 to 850 rpm) respectively. The experiment was carried out on a 10.5mm hole drilled on a spring steel (SUP11A) flat and was kept constant throughout the experiment. The high speed steel (HSS) drill bit was also kept constant throughout the experiment. The Drilling parameters and their levels are shown in the following table.

TABLE 1: Drilling Parameters and their Levels
 Since the metal selected for experiment is SUP11A, is a type of Spring Steel (Carbon Steel) having adequate properties for a spring. The composition (in %) of SUP11A is shown in the following table.

C	Si	Mn	P	S	Cr	B
0.6	0.23	0.91	0.0	0.0	0.82	0.00
1			3	3		05

TABLE 2: Composition of SUP11A

Selection of Orthogonal Array (OA)

Since there are 2 parameters and 3 levels, the L9 orthogonal array has been selected. [9]

Factors	Surface Roughness Parameters			
	A	B	C	D
Experiments	Feed Rate	Speed	Errors	Errors
1	1	1	-	-
2	1	2	-	-
3	1	3	-	-
4	2	1	-	-
5	2	2	-	-
6	2	3	-	-
7	3	1	-	-
8	3	2	-	-
9	3	3	-	-

TABLE 3: Experimental Layout using an L9 OA

Calculation of S/N Ratio

In this paper, since the surface roughness has to be optimized, so lower-the-better characteristic would yield the optimum results. The S/N ratio for lower-the-better characteristic can be given as-

$$S/N = -10\log(\text{MSD}) \quad [14]$$

Where, MSD = Mean Square Deviation in the output characteristic and is given as-

$$\text{MSD} = \frac{1}{n} \sum_{i=1}^n y_i^2 \quad [14]$$

Where, n = No. of observations
 yi = Observed data

Test Drive	Surface Roughness (µm)	S/N Ratio (dB)
1	1.5	-3.5218
2	1.2	-1.5836
3	1.0	0
4	1.7	-4.6089
5	1.4	-2.9225
6	1.2	-1.5836
7	2.0	-6.0206
8	1.8	-5.1054
9	1.6	-4.0824

TABLE 4: Experimental Results for S/N Ratio

Since the experimental design is orthogonal, it is then possible to separate out the effect of each parameter at different levels [10]. For example,

the mean S/N ratio for the feed rate at levels 1, 2 and 3 can be calculated by averaging the S/N ratios for the experiments 1–3, 4–6 and 7–9 and respectively. The mean S/N ratio for each level of the other parameters can be computed in the similar manner. The mean S/N ratio for each level of the parameters is summarized and called the S/N response table for the total surface roughness [10].

Symbol	Parameters	Mean S/N Ratio (dB)		
		Level 1	Level 2	Level 3
A	Feed Rate	-1.7018	3.0383	5.0695
B	Speed	4.7171	3.2038	1.8887

TABLE 5: S/N response table for the total surface roughness

Results

On the basis of various experiments and analysis carried out, following are the results that we obtained.

The following figures show the S/N response graph.

The graph to show the effect of feed rate has been plotted (fig. 3.).

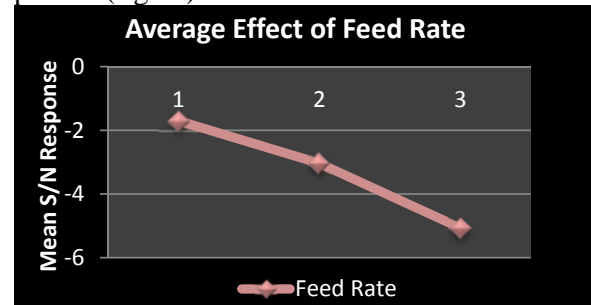


Fig.3: Effect of Feed Rate

The graph to show the effect of Speed has been plotted (fig.4.).

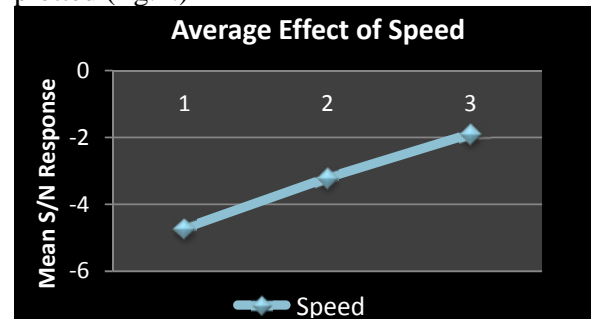


Fig.4: Effect of speed

The combined effect has been shown in the graph (fig. 5)

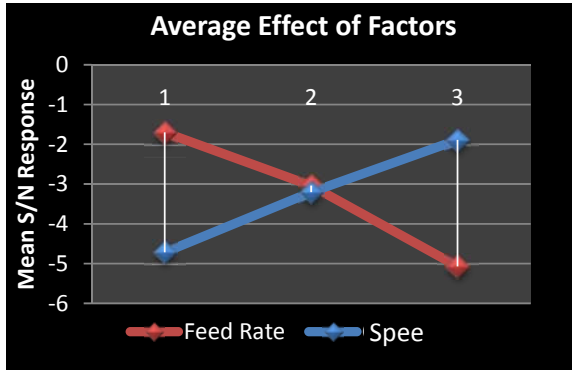


Fig.5: Effect of drilling parameters

ANOVA is a statistically based, objective decision-making tool for detecting any differences in the average performance of groups of items tested [15]. ANOVA helps in formally testing the significance of all main factors and their interactions by comparing the mean square against an estimate of the experimental errors at specific confidence levels. This is accomplished by separating the total variability of the S/N ratios, which is measured by the sum of the squared deviations from the total mean S/N ratio, into contributions by each of the design parameters and the error.

The purport of the analysis of variance (ANOVA) was to gain those parameters which are significantly affecting the quality attribute. The total sum of square deviation, SS_T can be calculated using [14]

$$SS_T = \sum_{i=1}^y y_i^2 - C.F$$

Where, n represents the number of experiments in the orthogonal array, y_i is the total surface roughness of i^{th} experiment and $C.F.$ is the correction factor. $C.F$ may be computed as:

$$C.F = \frac{T^2}{N}$$

Where, T is the sum of all total surface roughness.

The total sum of square deviations i.e. SS_T was segregated into two ways: the sum of squared deviation, SS_d owing to each process parameter and the sum of square error, SS_e . The percentage contribution which is denoted by P , in which each process parameter is the total sum of square deviation, SS_T that is a ratio of the sum of square

deviation, SS_d because of each process parameter to the total sum of square deviation, SS_T .

To the point of view of statistical study, there is a test called F -ratios (variance ratio) to study which parameters have significant effects. For performing the F test, the mean of square deviation, SS_m due to each process parameter requires due calculation. The mean of square variations, SS_m is equal to the sum of square deviation, SS_d divided by the number of degree of freedom linked with the process parameters. As a result of it, the F value for each process parameter is merely the ratio of the mean of square deviation, SS_m to the mean of square error, SS_e .

Sym.	Para- meters	DO F	Sum of Squar es (SS)	Vari- ance (V)	Vari- ance Ratio (F)	Contri- - bution (%)
A	Feed Rate	2	17.25 3	8.62 6	50.74	57.6
B	Speed	2	12.01 9	6.00 9	35.35	40.1
	Errors	4	0.68	0.17		2.27
	Total	8	29.95 2			

TABLE 6: ANOVA table for % Contribution Calculation

From the above ANOVA table (Table 6) , the percentage contribution of each parameter is calculated. The contribution of these parameters is:

Feed rate = 57.6%
Speed = 40.1%

From the above results it can be seen that the feed rate is the most significant factor that contributed the maximum to the surface roughness of the material due to drilling. Thus based on the S/N ratio and ANOVA, the optimum combination of the parameters and their levels for achieving the optimum surface roughness is A1, B3 i.e., feed rate at level 1 and speed at level 3.

Pie diagram and bar chart to show the contribution of various process parameters has been drawn (fig.6& fig.7)

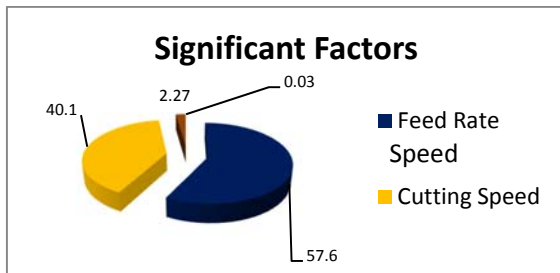


Fig 6: Contribution of Significant Factors (a)

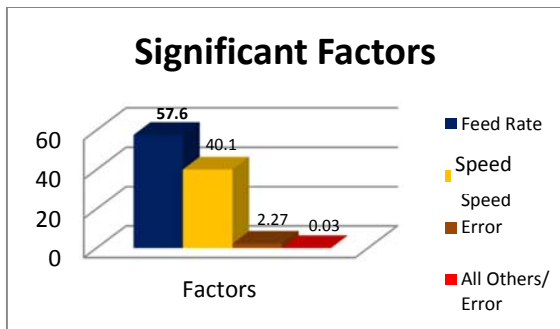


Fig 7: Contribution of Significant Factors (b)

Confirmation Test

The confirmation test is used to verify the estimated results with the experimental results. If the optimal combination of parameters and their levels coincidentally match with any one of the experiments of the OA, then the confirmatory test is not required. The confirmation test was not required in the present study because the optimum combination of parameters and their levels, i.e., A1, B3 matched with the third experiment of the OA.

Conclusions

From the analysis of the results of the present study, the following can be concluded:

- Taguchi's robust design method is suitable for optimizing the surface roughness of a drilled hole of a leaf spring material SUP 11A.
- The significant parameters for the surface roughness in drilling SUP 11A are feed rate and speed with their contribution of 57.6% & 40.1% respectively.
- The optimal conditions for the surface roughness in drilling SUP 11A are A1, B3 i.e., the feed rate of 0.05 mm/rev and speed of 850 rpm respectively.

References

- [1] R.S. Khurmi, JK Gupta; *A Textbook of Machine Design*; S.Chand Publication; Edition 2006
- [2] B.Y. Lee, H.S. Liu, Y.S. Tarn; *Modelling and optimization of drilling process*; *Journal of Materials Processing Technology* 74 (1998) 149–157.
- [3] Chen WC, Tsao CC (1999) Cutting performance of different coated twist drills. *J Mater Process Technol* 88:203–207
- [4] Zhao H (1994) Predictive models for forces, power and hole oversize in drilling operations. PhD thesis, University of Melbourne, Australia
- [5] Nanaji Kshirsagar, Awneesh Yadav, Srinivas Athreya, Sahil Patil, Rizwan Hassan, Vineeth Menon; *Surface Finish Optimization by Taguchi Method*; *Proceedings of the NCNTE-2012, Third Biennial National Conference on Nascent Technologies Fr. C. Rodrigues Institute of Technology, Vashi, Navi Mumbai, Feb 24-25, 2012 Department of Mechanical Engineering.*
- [6] W.H. Yang, Y.S. Tarn; *Design optimization of cutting parameters for turning operations based on the Taguchi method*; *Journal of Materials Processing Technology* 84 (1998) 122–129
- [7] D.C. Montgomery, *Design and Analysis of Experiments*, Wiley, Singapore, 1991.
- [8] R.A. Fisher, *Statistical Methods for Research Workers*, Oliver and Boyd, London, 1925.
- [9] Peter Woolf; e-book for *Design of Experiments: Taguchi Methods*; version 1.0; University of Michigan
- [10] S. Kamaruddin, Zahid A. Khan and S. H. Foong; *Application of Taguchi Method in the Optimization of Injection Moulding Parameters for Manufacturing Products from Plastic Blend*. *IACSIT International Journal of Engineering and Technology*, Vol.2, No.6, December 2010 ISSN: 1793-8236.

- [11] Phadke MS (1989) Quality engineering using robust design. Prentice-Hill, Englewood Cliffs, NJ
- [12] Tarun Goyal, Ravinderjit Singh Walia, and T. S. Sidhu; Study of Coating Thickness of Cold Spray Process Using Taguchi Method; *Materials and Manufacturing Processes*, 27: 185–192, 2012 Copyright © Taylor & Francis Group, LLC.
- [13] Y. S. Tarn and W. H. Yang; Department of Mechanical Engineering; National Taiwan University of Science and Technology; Application of the Taguchi Method to the Optimization of the Submerged Arc Welding Process; *Journal of Materials and Manufacturing Processes*, Vol. 13, No.3, 455-467, 1998
- [14] Roy, R.K., 1990, "A *Primer on the Taguchi method*". Competitive Manufacturing Series, Van Nostrand Reinhold, New York.
- [15] Minitab User Manual Release 13.2 (2001) Making data analysis easier. MINITAB Inc., State College, PA
- [16] Ramon Balisnomo; Introduction to Taguchi Methods; Presentation; September 5, 2008.
- [17] Rudolf N. Cardinal; Guide to ANOVA; Graduate-level statistics for psychology and neuroscience; ANOVA in practice, and complex ANOVA designs; Version of 2 May 2004.

HIERARCHY IN POWER IN THE HISTORY OF CIVILIZATION: A CRITIQUE OF V.S. NAIPAUL'S TRAVELOGUE, INDIA A WOUNDED CIVILIZATION

Deepti Bhargava
Assistant Professor, Department of Applied Science and Humanities,
IPS-CTM, Gwalior (M.P)
Email: d.bhargava29@gmail.com

Abstract

A close analysis of Naipaul's travelogue depicts the truth that his works are an attempt to understand his own past, to come to terms with it and to some extent, at least, to silence and mitigate his nagging awareness of not being too close to India but also not too far from her. Therefore, Naipaul is a merciless provocateur and somewhat narcissistic writer who constantly challenges the received wisdom of time in dealing with the predicament of the colonial and postcolonial situations and he continues to surprise, excite, provoke and even hurt his readers, especially Indians, at every turn of his literary voyage across this country.

Keywords: V.S. Naipaul, Travelogues on India.

Introduction

Mr. V.S. Naipaul, born in Trinidad (an island in West Indies just off the northeastern coast of Venezuela), has a distinctive and conspicuous position in the galaxy of the Diaspora writers. With a literary career of spanning half a century and more than 30 genre-defying books to his credit, Naipaul's entire contribution to literature is a spiraling either around the expatriate themes or his first hand encounters and experiences on his ancestral land India since both are central to his thinking process and creative effusion. Having a terrifying passion for truth, even if it is sour, Naipaul exposes the wounds on the minds and hearts of the colonized people who are beyond all hopes of healing or redress. No doubt, Naipaul is a writer with Eurocentric sensibility and so he is defiant in his observations and assertions but he spares none and so has become notorious for his views on the postcolonial situations, socio-cultural aspects and development prospects of the culture and civilizations of the Third World nations in general and India in particular.

Study of the book: India A Wounded Civilization

Naipaul continues his assault on India in the second book of his acclaimed Indian trilogy and, like the first one, *Wounded* is also a travelogue written during his visit to India in 1975 and now the writer seems to have acknowledged the dignity of exposing the maladies of his country with little humility. When Naipaul had first visited India he was very provocative in his assertions and so all the Indians were deeply hurt and humiliated. Actually on the very first visit his disillusionment with his ancestral land was quite bewildering and, so he could really not rise above the filth, poverty, and unhygienic life of Indians. But in this book Naipaul starts observing Indian culture, religion, the political system and though he is very critical yet considers and speaks of the real challenges faced by India before and after independence in a more convincing way.

Here also Naipaul is quite critical of Gandhi and his ideological views that have been otherwise acknowledged the world over for their power to sustain humanity. Naipaul criticizes the

simplicity preached by Mahatma because he thinks that Gandhian philosophy finds solace in poverty, **“Mr. Nehru had once observed that a danger in India was that poverty might be deified. Gandhianism had that effect. The Mahatma's simplicity had approved to make poverty holy, the basis of all truth, and a unique Indian possession. And so, for twenty years after independence, it had more or less remained”** (*wounded*, 38). To him it is surprising that Gandhian India had been very swiftly created in just eleven years, between Gandhi civil movement in 1919 and his Salt March in 1930. Naipaul writes,

“Gandhi had given India a new idea of itself, and also given the world a new idea of India. In those eleven years nonviolence had been made to appear an ancient, many-sided Indian truth, an eternal source of Hindu action. Now of Gandhianism there remained only the emblems and the energy; and the enemy had turned malignant. India needed a new code, but it had none. There were no longer any rules; and India so often invaded, conquered, plundered, with a quarter of its population always in the serfdom of untouchability, people without a country, only with masters was discovering again that it was cruel and horribly violent”(*wounded*, 16).

Naipaul found the Hindu religion solely responsible for such inhuman discrimination and exploitation of the greater part of the society and so he is very critical of Hindu belief system,

“Hinduism hasn't been good enough for the millions. It has exposed us to thousand years of defeat and stagnation. It has given men no idea of a contact with other men, no idea of the state. It has enslaved one quarter of the population and always left the whole fragmented and vulnerable.” (*Wounded*, 43).

To the ancient Aryans the untouchables were ‘walking carrion’; Gandhi - like other reformers before him sought to make them part of holy Hindu system. He called them *Harijans*, children of God. A remarkable linguistic coincidence: they have remained God's chillum. It is ironical that independence. The antique violence remained: rural untouchability as serfdom, maintained by terror and sometimes by deliberate starvation.

Naipaul does not hesitate in criticizing the Gandhian principles of semi-religious nature of his politics. His skepticism is so rude that he dares to question and even disapprove Gandhi's mahatmahood. Naipaul's is very vindictive in saying;

Gandhi himself (like Tolstoy, his early inspiration) declines into a long and ever more private mahatmahood. The obsessions were Tolstoy an-sexual anxieties in old age, after forty years of abstinence. This period of decline was the period of his greatest fame; so that even while he lived, ‘he became his competitive piety. Knowledge of man as a man was lost; mahatmahood submerged all the ambiguities and the political creativity of his early years, the modernity (in India) of so much of his thought. He was claimed in the end by old India, that very India whose political deficiencies he had seen so clearly, with his South African eye. (*Wounded*, 141)

Naipaul says that, no doubt, Gandhi swept through India but he left it without an all accepted ideology and so his worshippers have become vain and ineffective after him. For additional verification, Naipaul turns to the memoirs of Mahatma Gandhi. As a young man, Gandhi was possessed with the idea of moving to Britain to study the law. Against the odds, he succeeded in this task and records his maritime trip to the imperial centre and his studies in the approach to the bar. Yet, as Naipaul observes, Gandhi seems to notice nothing going on around him and this continues when he is elsewhere and his focus is almost entirely internal. Gandhi is also experiencing his being but he does not notice as important those events occurring outside of him when there is so much going on inside his consciousness. Major Indian religions and philosophies emphasize the importance of cultivating the inner being after all. In this context he says that even their greatest social reformer, the father of nation Mahatma Gandhi failed to teach them lesson of brotherhood, self-reliance and hard work. Even the food habits of the Indian people horrified Naipaul and he could not bear the very idea of serving food to animals on the same plate in which people themselves eat. He writes with full belief that Indian society is wholly diseased and irreparable as sanitation was linked to caste, caste to callousness, inefficiency and a hopelessly

divided country, division to weakness, weakness to foreign rule. Speaking about the Gandhi's views of universal brotherhood Naipaul says that no one of purely Indian sensibility could have seen so clearly and so Gandhi emerged as a colonial blend of the East and West, Hindu and Christian. The spirit of service, excrement, bread labor, the dignity of scavenging, and excrement again Gandhi's obsessions even when we resolve non-violence, when we set aside all that he sought to make of himself, and concentrate on his analysis of India seem ill-assorted and sometimes unpleasant.

About Gandhi, the Mahatma, Naipaul writes that when Gandhi returns to India for good, in his mid – forties , he is fully made; and even at the end, when he is politically isolated and almost all holy man, the pattern of his foreign-created mahatmahood holds. In the turmoil of independence the killings, the mass migration between India and Pakistan, the war in Kashmir he is still obsessed with the idea of self control and abstinence.

Moreover, to Naipaul the *Ram raj* that Gandhi offered is no longer simply independence. India without the British; it is people's government, the re-establishment of the ancient Indian village republic, a turning away from the secretariats of Delhi and the state capitals. But he opines that this is saying nothing; this is to leave India where it is .What looks like a political program is only glamour and religious excitation. People's government and the idea of the ancient village republic are not the same thing.

Old India has its special cruelties; not all the people are people. Even if Gandhi took India out of one kind of *Kal Yug*, one kind of Black Age; his success inevitably pushed it back into another. The difficult lessons of South Africa were simplified and simplified in India: ending as a holy man's fad doing the latrine-cleaning work of untouchables, seen only as an exercise in humility , ending as a holy man's plea for brotherhood and love, ending as nothing (*wounded*,143).

Therefore, even the Moslems fell away from Gandhi due to his Hindu ways of Mahatmahood and they turned to their own Moslem leaders, preaching the theory of two nations on religious line. In 1947 the country was partitioned, and many millions were killed and many more millions expelled from their ancestral land; as

great a holocaust as that caused by Nazi Germany. And in 1948 Gandhi was killed by a Hindu for having undermined and betrayed Hindu India. To Naipaul it is irony upon that Gandhi's mahatmahood in the end had worked against his Indian cause.

Naipaul reiterates that Bhave and so many other Gandhians still do propagate what Gandhi had said many years ago, **“Our first step will be to get Gram-Raj (Government by the village): then lawsuits and disputes will be judges and settled within the village. Next it will be Ram Raj (the Kingdom of God): then there will no longer be any lawsuits or disputes, and we shall all live as one family.’ Bhave said that more than twenty years ago and something like that is being said others today, in the more desperate circumstances of the emergency”** (*Wounded*, 145). Therefore, by a life of strenuous parody Bhave has swallowed his master and in his parody all the human complexity of the mahatma has been dimmed into mere holiness. Thus the Gandhian ideal is the withering away of the state.”**Independent India, Gandhianism is like the solace still of a conquered people, to whom the state has historically been alien, controlled by others.** (*Wounded*,145).

After independence India faced many challenges. The average Indian was very little equipped to cope up with these challenges. Naipaul says, India – for the first time in the history – was starting to realize its own fragile state. The Hindu world, he says, shatters as soon as it tries to expand. He chose multiple Indian novels to make his argument and he partially succeeds in this attempt, especially when he precisely exposes Indian attitudes of worldly defeat. Naipaul says, this characteristic Indian attitude caused the death of this great civilization.

Being an ancient civilization, India should have advanced quickly. But instead it become more and more archaic. The reason, Naipaul believes, lies in the subtle effects of constant invasions for past thousand years. He says the whole creative side of India has died because of this conquering. The effects are evident in Indian paintings, cinema, music, and architecture. With each one of this art forms, Naipaul says, the tradition has been broken. He believes this creative loss has gone unnoticed for generations.

The real India remains so little known to Indians, he says. People lack the ability of social inquiry. The habits of analysis are foreign to this land. And because of this lack of observation, Indians don't have any ideas, instead they have obsessions. And these obsessive lives act like a collective amnesia blurring the past quickly. The intellectual second-rateness caused by the Indian attitudes make India more crippled and India has so little to offer to the world. He says, the self-absorption – the retreat of Hindu mind – causes an enormous defect of vision, which further hinders the development process. Naipaul believes that, for too long Indians – as conquered people – have been intellectually parasitic on other civilizations. He questions the contribution of the Indian scientist to the world in the past thousand years. Again, he attributes these failures to the excessive religious influences.

Naipaul attributes the lack of intellectual growth to the underdeveloped ego of Indians. The underdeveloped ego, he says, has permeated through the entire social organization. It pushes Indians away from individuality and makes them less adventurous. And as a result deprives them of possible excellence in any field of study.

With this newly given freedom if India has to survive, Naipaul believes, it needs to break away from its old patterns. The turbulence in India didn't come from invasions, but it generated from within. And India can not afford to respond in an old way. Naipaul warns that the old Hindu retreat will make India more archaic. Naipaul believes that the borrowed institutions from the western world, like judicial system and constitution in general, will not be able to succeed because of the fundamental flaws in the civilizations. India needs institutions that are based on its own value system, and these systems need to evolve gradually towards more relevant modern world systems.

Naipaul comes to assess that no government can survive on Gandhian fantasy; and the spirituality, the solace of a conquered people, which Gandhi turned into a form of national assertion, has soured more obviously into the nihilism that it always was. He further says that the stability of Gandhian India was an illusion and India will not be stable again for a long time. The crisis of India is neither political nor economic, **“These are only aspects of the**

larger crisis, which is that of a decaying civilization where the only hope lies in further swift decay” (*Wounded*, 161).

Outcome from the study

A close analysis of Naipaul's Indian travelogues depicts the truth that these works are his attempt to understand his own past, to come to terms with it and to some extent, at least, to silence and mitigate his nagging awareness of not being too close to India but also not too far from her. For instance, at the initial stage of his career he made England his self-proclaimed home but in the recent years of the 21st century one could spot this literary giant in tweeds enjoying a quick drink with his Pakistani new wife Nadira in the bar of a Delhi hotel very often – India has emerged as his second home. Though Naipaul's intellectual bent is towards the western habits of thought, yet he could not throw away the baggage of his past and his literary works have the involvement of the Indian people whether he deals with the Trinidadian society or the Indian one.

Naipaul and all such audaciously critical writers must learn the cardinal truth that no spiky provocation of criticism can ever falsify Gandhian philosophy of the life and the world. Whatever the profile of Naipaul as a writer, he remains an affected person possessing the pride and prejudices of a spoiled intellectual of the modern times who is not spiritually enlightened enough to reckon the human values of Gandhian philosophy and, so only forms misconceptions about the great soul and his visionary ideas. Mahatma Gandhi was a legendary thinker and a saint beyond any dispute and Naipaul's ridiculous observations and open criticism of Gandhiji in his trilogy of Indian travelogues have harmed not to the saint but to his narcissistic writer himself who has faced the condemnation the world over.

REFERENCE

1. V.S NAIPAUL, INDIA: A WOUNDED CIVILIZATION, (FIRST PUBLISHED BY ANDRE DEUTSCH IN 1977). LONDON: PICADOR-AN IMPRINT OF PAN MACMILLAN LTD., 2002. (ALL THE QUOTES IN THE ARTICLE REFERRED AS WOUNDED AND FOLLOWED BY PAGE NUMBER(S) ARE FROM THIS EDITION OF THE TRAVELOGUE).

AN APPROACH TO STUDY THE ATMOSPHERIC ELECTRIC FIELD USING EFM SYSTEM

Anupma Agarwal¹, Shourabh Bhattacharya²

¹Department of Applied Science & Humanities, IPS-CTM Gwalior (M.P)

²Department of Applied Physics, MITS, Gwalior (M.P)

Email: anupma.agarwal@yahoo.com¹, shourabhbhattacharya@gmail.com²

Abstract

The study of localized atmospheric electric field is expected to reflect upon the changes that take place in the near earth environment. The atmospheric earth electric field has been observed to serve as an important parameter which provides information about atmospheric – ionospheric coupling. The behavior of atmospheric electric field is reasonably different in normal weather condition and the condition due to perturbed climate state. In this paper, the authors intent to discuss the demonstration how the electric field mill perform and certain figure have been presented on a very basic level to reflect upon the kind of data being recorded by the field mill for complex analysis.

Keywords: Atmospheric-ionospheric coupling, thunderstorm, fair weather condition

INTRODUCTION:

In the recent times, the atmospheric dynamics have been a point of great interest to research community. When it comes to the exploration of the changes in the atmosphere, the vertical component of the localized electric field is observed to have played an important role towards characterizing the behavior of atmosphere. Under the “fair weather condition” electric field varies from 100V/m to 200V/m (Pulinets et al. 2006) but any kind of disturbance in atmosphere causes the variation in electric field due to movement of charges. Sometimes it is observed that even a greater degree of change in atmospheric electric field may indicate a severe weather condition. Atmospheric anomalies are interrelated with changes taking place in atmospheric electric field referred as global electric circuit. Global electric circuit is influenced by meteorological processes (Rycroft et al, 2000). The changes taking place in the atmosphere need to be monitored continuously as the atmospheric electric field is one of the major constituents of global electric circuit

(Bering III et al., 1988). The average value of vertical gradients of localized field has also been studied in this context for electrically calm days (Murri et al., 1973). The AEF is regulated by variation in climatic conditions such as rainfall and lightning, and produces a vertical potential gradient in non thunderstorm or normal weather regions (Harrison, 2005). AEF shows different pattern in turbulent condition (Bennett et al. 2008). Perturbation in atmospheric electric field has been witnessed in case of cloudy and meteorologically active region, even presence of air mass e.g. aerosols, pollutants etc. affect the atmospheric electric field (Datta et al., 2004). These variable patterns of atmospheric electric field corresponding to unusual climatic activities characterize the global as well as localized atmospheric electric field. Sometimes heavy lightning jump may not always constitute any turbulent or disturbed weather conditions at ground (Pawar et al. 2010). Non observance of severe weather may be due to the short duration of flash rate. Sudden rise and fall takes place immediately in very short span of time (Bressan et al., 2004). To characterize the fair weather condition, daily variation in three parameters

namely the Earth electric field (E), vertical air earth current density, and atmospheric electrical conductivity (σ) are required. In normalized conditions it is found that the average values of above mentioned parameters are: Earth electric field (E) is 108 Vm^{-1} , air earth current density 1.85 Pam^{-2} and the average atmospheric electrical conductivity (σ) is 19.6 FS-m^{-1} (Guha et al, 2010).

METHOD AND MATERIAL:

To measure the localized electric field or vertical potential gradient an electric field meter (Mac Gorman et al. 1998) is used known as Electric Field Mill (EFM). EFM has been employed to observe and record the variation of the localized earth electric field regularly in Gwalior region. To avoid the interferences EFM is mounted on the roof top of the Madhav Institute of Technology and Science, Gwalior, Madhya Pradesh with the isolation.

In EFM, four electrodes are used to measure earth electric field. Two are exposed to near earth electric field and two are shielded from the field (Deshpande et al. 2000). These rotating electrodes come in contact with the earth electric field alternately (H. Bloemink, 2013). When exposed electrodes come in contact with the field, charges are induced on them and this induced charge moves back to the ground when shielded electrodes come in contact with the field (Ferro et al. 2011). Movement of charges from electrodes generates current which is found proportional to the strength of the electric field in contact.

Charges flowing on to and off of the sense electrodes will develop a voltage across the sense resistor. This voltage is amplified and fed into an analog switch along with an out of phase version of the signal.

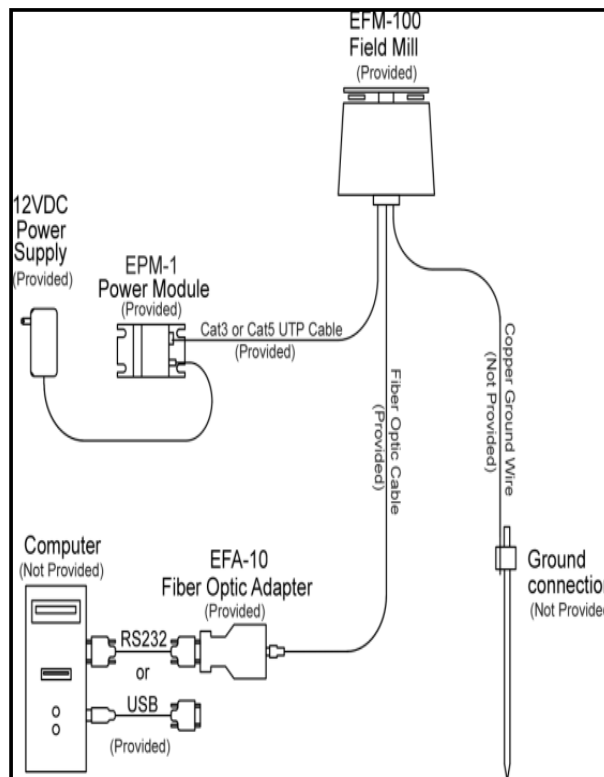


Figure 1 Block Diagram of Electric Field Mill

RESULTS AND DISCUSSION:

In this section the authors have presented the pattern how the electric fields are recorded with the data logger with initial diagram. The plot shows the variation of AEF along with the time of the day. Here four different pattern of AEF has been taken to compare and understand the variability of AEF pattern under different climatic (Turbulent to normal) conditions. Figure 2(a) shows the sudden variation in AEF on April 02, 2013 at 16:00 hrs which is termed as turbulent condition in which electric field attains the value about 6.47 kV/m , which is the indication of heavy rain fall and lightning activity. Heavy rainfall and lightning activity has been recorded at the same day (data taken by data server of climatic data centre). Figure 2(b) shows the phase transition in AEF pattern after the heavy rain fall and lightning activity. Phase transition in AEF pattern depicts the gradual normalization in climate on the same day. Followed the phase transition gradually normalization in localized AEF has been observed on the same day April02, 2013 in Figure 2(c). Figure 2(d) evinces the quiet period, referred as fair weather day on April 03, 2013.

Block diagram of Field Mill is shown below.

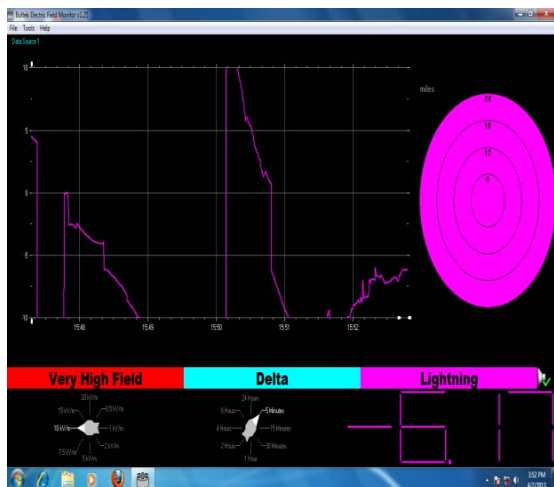


Figure 2(a) depict the occurrence of heavy rainfall and lightning activity on April 02, 2013 at 16:00 hrs

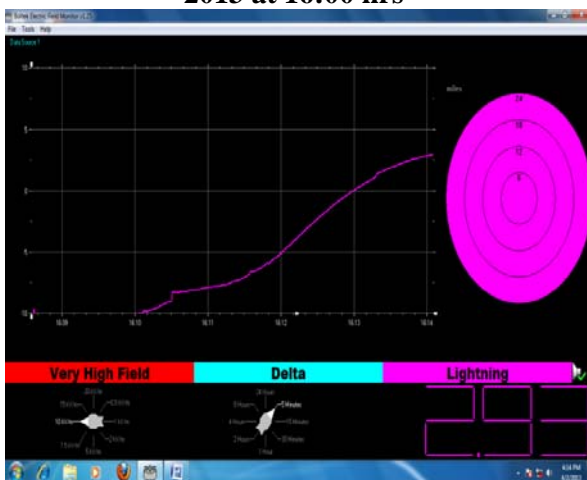


Figure 2(b) expresses the phase transition in AEF of April 02, 2013 after 16:10 hrs

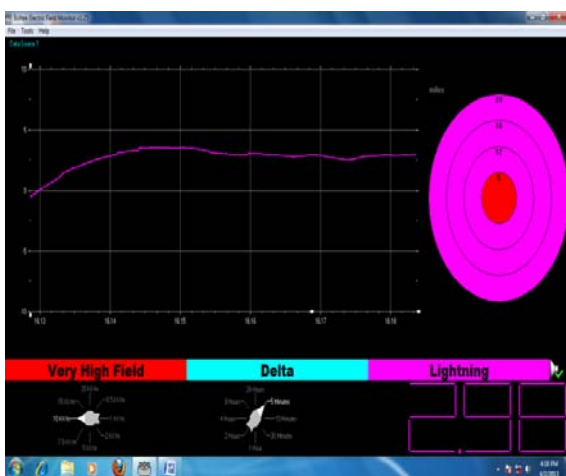


Figure 2(c) Gradually normalization in AEF on April 02, 2013

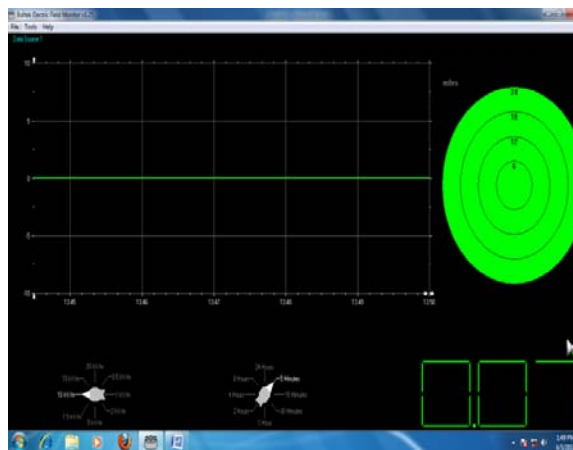


Figure 2(d) shows the pattern of AEF in fair weather condition on April 03, 2013

CONCLUSION:

In this paper, authors have presented the conditions of atmospheric electric field pattern which is measured using the locally set up electric field mill. The conditions refer to heavy rain fall, lightning activity to normal condition, which definitely is expected to help us characterize and understand the variability of atmospheric electric field pattern. The response of atmospheric electric field with unusual climatic condition can be seen clearly, which leaves an impression about the tendency of AEF in different climatic conditions, normal as well as disturbed.

ACKNOWLEDGEMENTS:

The authors sincerely thank the All India Council for Technical Education (AICTE), New Delhi, India and Madhav Institute of Technology and Science (MITS), Gwalior, India for providing necessary support.

REFERENCES:

- [1] H. Bloemink, State electricity measurements for lightning warnings; an exploration, version 1.0, INFRA – R & D, KNMI
- [2] Marco Antonio da Silva Ferro, Jorge Yamasaki, Douglas Roberto M. Pimentel, Kleber Pinheiro Naccarato and Marcelo Magalhaes Fares Saba, Lightning risk warning based on atmospheric electric field measurements in Brazil, doi: 10.5028/jatm.2011.03032511
- [3] A. Guha, B. K. De, S. Gurubaran, S.S. De and K. Jeeva, First result of fair weather atmospheric electricity measurement in Northeast India, J. Earth Syst. Sci. 119, No.2, pp. 221-228, April 2010

- [4] S. D. Pawar, P. Murugavel and V. Gopalakrishnan. Anomalous electric field changes and high flash rate beneath a thunderstorm in Northeast India, *J. Earth Syst. Sci.* 119. No. 5, October 2010, pp. 617-625
- [5] A. J. Bennett and R. G. Harrison, Variability in surface atmospheric electric field measurements. *Journal of physics, conference series* 142 (2008) 012046 doi: 10.1088/742-6596/142/1/012046
- [6] S. Pulinets, G. Bisiacchi, J. Berlinski, M. Dunajecka and A. Vega, First result of the new type of measurements of atmospheric electric field in Mexico, *Bol-e*, vol. 2, No. 4, 2006
- [7] Ed. R. G. Harrison, *The global atmospheric electrical circuit and climate*, GEOP220, The University of Reading, UK, 2005
- [8] Giorgio Bressan, Valter Gennaro, B. Dario Giaiotti and E. Fulvio Stel, Ground measurements of the Earth electric field, *Friulion Journal of Science* 5, 37-38, 2004
- [9] T. Datta and A. B. Bhattacharya, Atmospheric electrical field in relation to severe meteorological disturbances, *Indian Journal of Radio & space physics*, vol. 33, pp. 373-379, July, 2004
- [10] C. G. Deshpande and A. K. Kamra, The atmospheric electric field and conductivity measurements during XVI Indian Antarctica expedition, Sixteenth Indian expedition to Antarctica, Scientific report, 2000, Department of Ocean Development, Technical publication No. 14 pp. 1 to 36
- [11] M. J. Rycroft, S. Israelsson and C. Price, The global atmospheric circuit, solar activity and climate change, *Journal of atmospheric and solar terrestrial physics* 62(2000) 1563-1576
- [12] E. A. Bering III, A. A. Few and J.R. Benbrook, The global electric current, *Physics today*, 51(10): 24-30. 1998
- [13] D. R. MacGorman and D. W. Rust, *The electrical nature of storms*, Oxford University Press – Oxford, pp. 422 (1997)
- [14] A. Murri, R. Fusari and C. Scuterint, The mutual relation between solar activity, thunderstorms and vertical gradients of electro atmospheric potential, December, 1973

A MODEL TO STUDY CALCIUM DISTRIBUTION IN CARDIAC MYOCYTES

Sonia Shivhare

Amity University, Madhya Pradesh, Gwalior (MP)

Email: sshivhare@gwa.amity.edu

Abstract

Cardiac Myocytes are also known to state voltage-gated Ca^{2+} channels analogous in neurons. Calcium ion is a significant negotiator in cardiac Myocytes for excitation-contraction pairing. At the cellular stage, the real meaning of a heartbeat is a rise of calcium concentration. The increased concentration of Calcium causes a temporary disarticulation of contractile filaments, which shows the reduction of cell. Succeeding lessening of Ca leads relaxation of the my filaments and increase in the size of cell. The role of Calcium Distribution in Myocytes is not still well understood. The investigational approaches are very costly and time taken so problems of such mathematical modeling is one more substitute. In this paper it is planned to extend Mathematical Models to study Calcium Distribution in Cardiac Myocytes. Suitable boundary conditions have been framed.

Keywords: Ca^{2+} profile, buffer, Advection diffusion reaction

I. INTRODUCTION

Nowadays the up-and-coming area is Computational Biology which includes modeling of mathematics involved organs of human beings. Calcium [Ca^{2+}] is necessary for almost every method in human organs like heartbeat, contraction of muscles and very important in Cardiac Myocytes. Thus, recognition of the factors that involve the concentration of calcium ions has been a challenge.

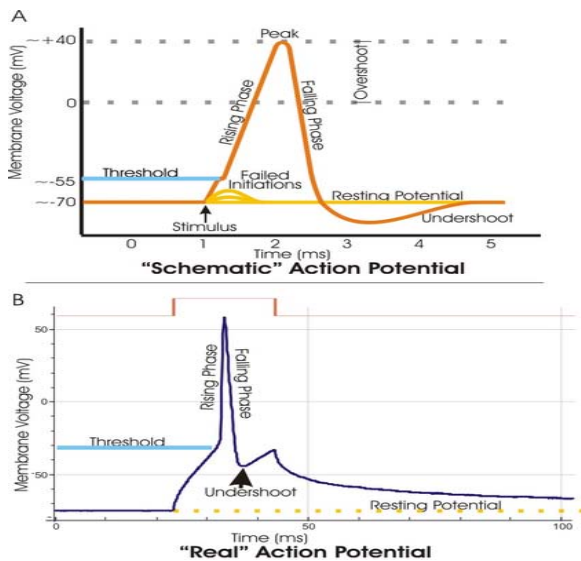
1.1 Calcium Signaling in Cardiac Myocytes

In inspiring the contraction of heart cells during the heart beat, concentration of calcium ions is very significant. Myocytes are heart cells which are accountable for expansion and contraction of heart, a procedure responsible for the pumping of blood from heart to the other parts of body. Calcium signaling which is taken place by reaction diffusion equation in myocytes for the functioning of heart. Through intracellular signals, the cells react immediately to their

surroundings. The modeling of these problems arise new challenges in the field of Mathematics.

As Ca^{2+} ions distribute far from voltage gated plasma membrane Ca^{2+} channels and approach towards the region having increased concentration of ions and trigger proteins connected with neurotransmitter release[1]. Association and releasing of free Calcium and other " Ca^{2+} buffers" conclude the variety of action of Ca^{2+} ions manipulating the time course of their effect and make easy clearance of Ca^{2+} [2]. In this paper, " Ca^{2+} Buffer" means Ca binding species. Ca^{2+} , confined to a small area discharge actions identified as Ca^{2+} "sparks" are observed in Cardiac Myocytes. Ca^{2+} sparks are mediated by RYRS located on the intracellular Ca^{2+} store of muscle cell, the sarcoplasmic reticulum (SR). Concentration coupling, Ca^{2+} sparks activated by Ca^{2+} in flux through sarcolemmal Ca^{2+} channels is the "building blocks" of global Ca^{2+} responses that cause muscles contraction. With the help of mathematical explanation of electrical actions in a cell, cardiac action potentials arise. To a great

extent the mathematical work of cardiac cell modeling is like neurons taken from the original work of Hodgkin and Huxley[3], who formulated a mathematical explanation of the giant squid axon (1952).



2. Literature analysis

Gregory D. Smith *et. al.*,[4] have proposed a Simple Numerical Model of Calcium Spark Formation and Detection in Cardiac Myocytes. According to their model, the elementary events of excitation-contraction coupling in heart muscle are Ca²⁺ sparks, which arise from one or more ryanodine receptors in the sarcoplasmic reticulum (SR). BACKX *et. al.*,[7] constructed a model of propagating Calcium-induced Calcium release mediated by Calcium diffusion. The model was used to evaluate whether propagation of calcium transients and the range of propagation velocities observed experimentally (0.05-15mm s⁻¹) could be predicted. Thomas R. Shannon *et. al.*,[6] developed the model includes the following novel features: (i) The addition of a subsarcolemmal compartment to the other 2 commonly formulated cytosolic compartments (junction and bulk) since ion channels in the membrane sense ion concentrations which differ from bulk. (ii) The use of realistic cytosolic Ca buffering parameters (iii) A reversible SR Ca pump (iv) A scheme for Na-Ca exchange transport which is [Na]_i-dependent and allosterically regulated by [Ca]_i and (v) A practical model of SR Ca release including both inactivation/adaptation and SR Ca load dependence. Luo and Rudy,[7] made a dynamic model of the cardiac ventricular action potential: Simulations of ionic currents and

concentration changes. A mathematical model of the cardiac ventricular action potential is presented in which The following processes are formulated: Ca²⁺ current through the L-type channel, the Na⁺-Ca²⁺ exchanger, Ca²⁺ release and uptake by the sarcoplasmic reticulum (SR), buffering of Ca²⁺ in the SR and in the myoplasm, a Ca²⁺ pump in the sarcolemma, the Na⁺-K⁺ pump, and a nonspecific Ca²⁺-activated membrane current. Depolarizations are induced by spontaneous Ca²⁺ release from the sarcoplasmic reticulum (SR), which, in turn, activates both the Na⁺-Ca⁺ exchanger and a nonspecific Ca²⁺-activated current (Ins(Ca)). The relative contributions of I_{NaCa} and of Ins (Ca₂₊) to the generation of DADs are different under different degrees of Ca²⁺ overload..The above discussion gives us the idea about mathematical model or calcium diffusion in cardiac myocytes and neuron cells by which various research workers. This background will be used to perform mathematical investigations on calcium dynamics in cardiac myocytes. Luo and Rudy [8] made another dynamic model of the cardiac ventricular action potential. Shannon *et. al.*, 2004 constructed a mathematical treatment of Integrated Ca dynamics within the ventricular myocyte. The model includes the parameters like (i) The addition of a subsarcolemmal compartment to the other 2 commonly formulated cytosolic compartments (junctional and bulk) since ion channels in the membrane sense ion concentrations which differ from bulk (ii) The use of realistic cytosolic Ca buffering parameters (iii) A reversible SR Ca pump (iv) A scheme for Na-Ca exchange transport which is [Na]_i-dependent and allosterically regulated by [Ca]_{ion} and (v) A practical model of SR Ca release including both inactivation/adaptation and SR Ca load dependence.

Objectives:

It is planned to extend mathematical models to realize the mechanism of Calcium dynamics in myocytes. The objectives of this study are as follows:

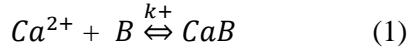
1. Analyzing the existing model of Calcium dynamics in Cardiac myocytes..
2. Modifying an extent the existing models of Calcium dynamics in Cardiac myocytes for studies in different situations.

3. Developing new models of calcium regulation in Cardiac myocytes which can be useful by bio mathematical scientists of clinical applications.

4. Studying the impact of various parameters like buffers, influxes, out fluxes, leaks and pumps on Calcium dynamics in Cardiac myocytes.

4. Methodology

By assuming a bimolecular association reaction between Ca^{2+} and buffer, we have



In equation 1, B represents free buffer, CaB represents Ca^{2+} bound buffer, and k^+ and k^- are association and dissociation rate constants, respectively. If we further assume that the reaction of Ca^{2+} with buffer follows mass action kinetics, we can write the following system of ODEs for the change in concentration of each species

$$\frac{d[Ca^{2+}]}{dt} = R + J \quad (2)$$

$$\frac{d[B]}{dt} = R \quad (3)$$

$$\frac{d[CaB]}{dt} = -R \quad (4)$$

Where the common reaction terms R, are given by

$$R = -k^+[Ca^{2+}][B] + k^-[CaB] \quad (5)$$

and J represents Ca^{2+} influx. Both R and J have units of concentration of per unit time.

Equations (2) to (4) are extended to include multiple buffers and the diffusive movement of free Ca^{2+} , Ca^{2+} bound buffer and Ca^{2+} free buffer. Assuming, Fick's diffusion in a homogeneous, isotropic medium, the system of reaction diffusion equations is written as [9].

$$\frac{\partial[Ca^{2+}]}{\partial t} = D_{Ca}\nabla^2[Ca^{2+}] + \sum_i R_i + J \quad (6)$$

$$\frac{\partial[B_i]}{\partial t} = D_{B_i}\nabla^2[B_i] + R_i \quad (7)$$

$$\frac{\partial[CaB_i]}{\partial t} = D_{CaB_i}\nabla^2[CaB_i] - R_i \quad (8)$$

Where the reaction terms, R_i , are given by

$$R_i = -k_i^+[Ca^{2+}][B_i] + k_i^-[CaB_i]$$

Where, i is an index over Ca^{2+} buffers, D_{Ca} , D_{B_i} , D_{CaB_i} are diffusion coefficients of free Ca^{2+} , bound calcium and free buffer respectively.

Since Ca^{2+} has a molecular weight that is small in comparison to most Ca^{2+} binding species, the diffusion constant of each mobile buffer is not affected by the binding of Ca^{2+} that is $D_{B_i} = D_{CaB_i} = D_i$. Substituting this in equation (7) & (8) and on summation it gives

$$\frac{\partial[B_i]_T}{\partial t} = \frac{\partial[CaB_i]}{\partial t} + \frac{\partial[B_i]}{\partial t} = D_i\nabla^2[CaB_i] + D_i\nabla^2[B_i] = D_i\nabla^2[B_i]_T \quad (10)$$

And

$$R_i = -k_i^+[Ca^{2+}][B_i] + k_i^-([B_i]_T - [B_i]) \quad (11)$$

Where

$$[B_i]_T = [CaB_i] + [B_i]$$

Thus, $[B_i]_T$, profiles are initially uniform and there are no sources or sinks for Ca^{2+} buffer, $[B_i]_T$ remains uniform for all times. Thus, the following equations are written for the diffusion of Ca^{2+} ,

$$\frac{\partial[Ca^{2+}]}{\partial t} = D_{Ca}\nabla^2[Ca^{2+}] + \sum_i R_i + J \quad (12)$$

$$\frac{\partial[B_i]}{\partial t} = D_{B_i}\nabla^2[B_i] + R_i \quad (13)$$

Where

$$R_i = -k_i^+[Ca^{2+}][B_i] + k_i^-([B_i]_T - [B_i]) \quad (14)$$

Here both R_i & J have units of concentration per unit time.

Considering simplification of equations (2) to (4) that come about when buffer parameters are in select regimes: the so called "excess buffer" approximation.

In the excess buffer approximation (EBA), equations (2) to (4) are simplified by assuming that the concentration of free Ca^{2+} buffer $[B_i]$, is high enough such that its loss is negligible. The EBA gets its name because this assumption of the unsaturability of Ca^{2+} buffer is likely to be valid when Ca^{2+} buffer is in excess.

4.1 Initial and Boundary conditions & Geometry of Simulations

To complete a reaction – diffusion formulation for the buffered diffusion of Ca^{2+} , a particular geometry of simulation must be specified and equation (2) – (4) must supplement with boundary conditions and initial concentration profiles. If Ca^{2+} is released from intracellular Ca^{2+} stores deep within a large cell (so that the plasma membrane is far away and doesn't influence the time course of the event), and the intracellular milieu is homogenous and isotropic, then we have spherical symmetry.

In this case the evolving profiles of Ca^{2+} and buffer (through a function of time and distance from the source) will not be a function of the polar (f) or azimuthally (q) angle. In the case of such spherical or radial symmetry the Laplacian Ca^{2+} reduces to

$$\nabla^2 = \frac{1}{r^2} \frac{\partial}{\partial r} \left[r^2 \frac{\partial}{\partial r} \right] = \frac{\partial^2}{\partial r^2} + \frac{2}{r} \frac{\partial}{\partial r}$$

The reasonable initial condition for this simulation is uniform background Ca^{2+} profile of $[Ca^{2+}]_{\infty} = 0.1 \mu M$. we require buffer far from the source to remain in equilibrium with Ca^{2+} at all times.

$$\lim_{r \rightarrow \infty} [Ca^{2+}] = [Ca^{2+}]_{\infty} \quad (15)$$

And

$$\lim_{r \rightarrow \infty} [B_i] = [B_i]_{\infty} \quad (16)$$

Near the source, the boundary conditions

$$\lim_{r \rightarrow \infty} \left(4\pi D_c r^2 \frac{\partial [Ca^{2+}]}{\partial r} \right) = \sigma \quad (17)$$

and

$$\lim_{r \rightarrow \infty} \left(4\pi D_c r^2 \frac{\partial [B_i]}{\partial r} \right) = 0 \quad (18)$$

We define an influx of free Ca^{2+} at the rate σ by faraday's law,

$$\sigma = \frac{I_{ca}}{ZF}$$

5. Possibilities of the study

The modeling of the calcium dynamics in myocytes gives new challenges for mathematics. The future study will initially direct to produce information regarding drawbacks, restrictions and gaps in the presented models and studies of calcium dynamics in cardiac myocytes. Subsequently the proposed study may lead to modifications an extension of existing models of calcium dynamics in cardiac myocytes. Also, it will lead to development of new models of calcium dynamics in cardiac myocytes. Addressing the existing issues and challenges of such studies. Apart from this, it will lead to development of new mathematical approaches for solution involving advanced mathematical and numerical techniques like integral transforms, special functions, finite element, finite difference methods. The proposed study will generate information about interrelationship among various parameters and their impact on calcium dynamics in cardiac myocytes. The information generated will be better insights of mechanisms involved in calcium dynamics

in cardiac myocytes which will be quite useful to biomedical scientists for developing protocols for diagnosis and treatment of heart diseases. In all the proposed study will contribute new knowledge not only to mathematical sciences but also to computational neurosciences.

6. Reference:

1. Carmeliet. 1999 *Physiol. Rev.* vol. 79pp 917-1017.(sarcolemma2)
2. Heping Cheng and W. J. Lederer 2008 *Physiol. Rev.* 88: 1491-1545
3. Hodgkin, A., and Huxley, A.(1952):Aquantative description of membrane current and its application in nerve. *J. physiol.* 117:500-544. PMID 12991237
4. Gregory D. Smith, Joel E. Keizer, Michael D. Stern, W. Jonathan Lederer, and Heping Cheng 1998 *Biophysical Journal* Volume 75 pp 15–32.
5. Peter H. Backx, P. P. De Tonbe, Jurjen H. K. Van Deen, Barbara J. M. Mulder, and Henke. D. j. Ter Keurs 1989 *J. G. Physiol.* Volume 93 pp 963-977.
6. Thomas R. Shannon, Fei Wang, Jos'e Puglisi, Christopher Weber and Donald M. Bers2 2004 *Biophys J* 104.047449
7. Luo and Rudy, 1994a *Circ. Res. Vol* 74 pp 1071-1096.
8. Luo and Rudy 1994b *Circ. Res. Vol* 74 pp1097-1113.
9. Kumar, Abbas, Fausto: *Robbins and Cotran Pathologic Basis of Disease*, 7th Ed. p. 556 (heart1).
10. Rao S.S., "The Finite Element Method in Engineering", 2004, Elsevier Science & Technology Books, ISBN 0750678283
11. Reddy J. N., "An Introduction to the Finite Element Method", 2005, Tata McGraw-Hill Publication Company Limited, ISBN 0-07- 053084-X.
12. Seshu P., "Textbook of Finite Element Analysis", 2003, Prentice –Hall of India Private Limited, ISBN 81-2003-23157.
13. Shannon T. R., Wang F., Puglisi J., Weber C. and Bers D. M., "A Mathematical Treatment of Integrated Ca Dynamics within the Ventricular Myocytes", *Biophysical Journal*, Volume 87, 2004, pp 3351-3371.
14. Smith G. D., Keizer J. E., Stern M. D., Lederer W. J. and Cheng H., "A Simple

Numerical Model of Calcium Spark Formation and Detection in Cardiac Myocytes”, Biophysical Journal, Volume 75, 1998, pp 15-32.

15. Shivhare S., “Variation finite element approach to study radial heat distribution problem in human limbs””, IOSR Journal of Mathematics, Volume 10, Issue 3 Ver. III, 2014, pp 45-48.

16. Tiwari S. and Pardasani K. R., “Finite Element Model to study the Two Dimensional Unsteady state Cytosolic Calcium Diffusion in Presence of Excess Buffers”, International

Journal of Applied Mathematics, 2010, 40 3 01.

17. Tripathi A. and Adalkha N., “Two Dimensional Coaxial Circular Elements in FEM to study Calcium Diffusion in Neuron Cells”, Applied Mathematics Science, Volume 06, 2012-466.

18. Shukla Y., “A mathematical approach to study temperature regulation of human body due to different arterial blood temperature”, IOSR Journal of Mathematics, Volume 10, Issue 2 Ver. I, 2014, pp 01-05.

OPTIMIZATION OF WELDING PARAMETER FOR ARC WELDING OF MILD STEEL PLATE (GRADE-40)

Dharmendra Singh Jadoun¹, Rajendra Prasad Kori², Dinesh Kumar Kasdekar³
Department of Mechanical Engineering, MITS, Gwalior (M.P)
Email.ID-sahil111@ymail.com¹

Abstract:

Welding is a basic manufacturing process for making components or assemblies. Recent welding economics research has focused on developing the reliable machinery database to ensure optimum production. There are many welding parameters in welding process, the major factors whose selection contributes to the welded product as they all affect the strength and quality to a larger extent are weld design (edge preparation), Root face, and Root gap. In this paper, the optimization of welding input process parameters for obtaining greater weld strength in the Electric arc welding of metal like mild steel is presented. The Taguchi method is adopted to analyze the effect of each welding process parameter on the weld strength, and the optimal process parameters are obtained to achieve greater weld strength. The study includes selection of parameters, utilizing an orthogonal array, conducting experimental runs, data analysis, determining the optimum combination, finally the experimental verification. Experimental results are provided to illustrate the proposed approach.

Keywords: Mild steel plate, welding parameters, Electric Arc Welding, Taguchi method.

INTRODUCTION:

Welding is a process of fabrication that joins materials usually metals or thermoplastics, by causing coalescence. This is often done by melting the work pieces and adding a filler material to form a pool of molten material (the weld pool) that cools to become a strong joint, with pressure sometimes used in conjunction with heat, or by itself, to produce the weld for joining the metals[1-2]. This is in contrast with soldering and brazing, which involve melting a lower-melting-point material between the work pieces to form a bond between them, without melting the work pieces. It has been found that ultimate tensile strength of weld joint in mild steel is largely influenced by thickness of material. Thus optimum setting of selected parameters i.e. thickness of material, carbon percentage of material and electrode diameter for mild steel is tried to obtain and verify using Taguchi and Minitab. Now a day, welding is extensively used in fabrications of

automobiles, aircrafts, ships, electronic equipment, machinery, and home applications etc. as an alternative of casting or as a replacement of riveted or bolted joints. There are two main types of arc-welding processes. They are shielded metal arc welding and gas shielded arc welding. The main advantages of shielded metal arc welding are that high-quality welds are made rapidly at a low cost. Shielded Metal Arc Welding, also known as manual metal arc welding, stick welding, or electric arc welding, is the most widely used of the various arc welding processes. Welding is performed with the heat of an electric arc that is maintained between the end of a coated metal electrode and the work piece.

2. Experiment Procedure

Arc welding is a type of welding that use a welding power supply to create an electric arc between an electrode and the base material to melt the metal at the welding point. They can use either direct (DC) or alternating (AC) current, and consumable or non consumable electrodes.

The welding region is usually protected by some type of shielding gas, vapor, or slag. Arc welding process may be manual, semi automatic or fully automatic. The heat generated by the electric arc is used to melt and join the base metal [3]. In this study an Electric arc welding machine is used to weld the base plates of Mild steel. The chemical composition of Mild steel is given in Table 1. Welding is carried out in the down hand position and beads are laid along the weld pad centerline to form a butt joint. The plates are allowed to cool to room temperature, after the completion of welding. To evaluate the quality of the Electric arc welds, a measurement of the tensile strength is performed by using an ultimate tensile testing (UTM) machine. The tensile strength of the weld has a higher-the-better quality characteristic. After welding, the joints are sliced in transverse direction to prepare the specimens for the purpose of to prepare the specimens for the purpose of measuring the tensile strength of the weld.

Fig 1 shows the electric arc welding process.



Fig.1.Electric Arc welding Process

Table 1 Chemical composition of Mild steel grade 40 in wt%

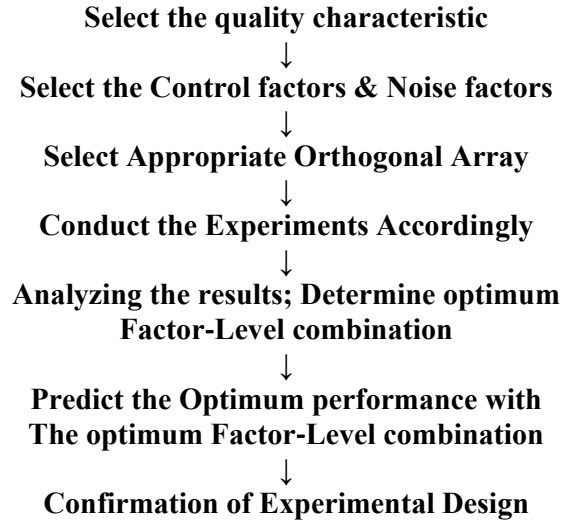
Element	C	Mn	P	S	Cu	Si	Ni	Cr	As
Weight %	0.37	0.90	0.04	0.04	0.03	0.07	0.03	0.02	0.08

3. Methodology

3.1 Taguchi Method:

Taguchi method is the process of engineering optimization in a three step approach namely system design, parameter design and tolerance design. In the system design, a basic functional prototype design will be produced by applying scientific and engineering knowledge. In parameter design, independent process parameter values will be optimized and where as in tolerance design, tolerances will be determined and analyzed for optimal values set

by parameter design. Taguchi method is a powerful design of experiments (DOE) tool for optimization of engineering processes.



3.1.1 Optimal selection of process parameters

In this section, the use of the Taguchi method [4-6] to determine the process parameters in the Electric arc welding of Mild steel plate. Optimal welding process parameters with greater weld strength are determined and verified.

Table 2: Process Parameters and their levels.

Parameter	Level1	Level2	Level3
Thickness of material(mm)	8	10	12
Carbon % of material.	0.4	0.6	0.8
Diameter of electrode(mm)	2.6	2.8	3.6

3.1.2 Orthogonal array Experiment

In the present study, three 3-level process parameters i.e. thickness of material, carbon percentage of material and diameter of electrode are considered. The values of the welding process parameters are listed in Table 2. The ranges and levels are fixed based on the screening experiments. The interaction effect between the parameters is not considered. The total degrees of freedom of all process parameters are 8. The degrees of freedom of the orthogonal array should be greater than or at least equal to the degrees of freedom of all the process parameters. Hence, L9 (3³) Orthogonal array was chosen which has 8 degrees of freedom. Table 3 shows the nine experiments based on L9 orthogonal array and their corresponding measured ultimate tensile strengths.

4. Results & Discussion

Taguchi Analysis: ultimate tensile versus thickness of material, carbon percentage of material, rod diameter (mm).

Table 4: Response Table for Signal to Noise Ratios (larger is better)

Level	Thickness of Material (mm)	Carbon percentage of Material	Electrode Diameter (mm)
1	71.29	75.31	75.08
2	75.61	74.29	73.87
3	75.43	72.73	73.37
Delta	4.32	2.59	1.71
Rank	1	2	3

Table 4 shows the response table for signal to noise ratio for Larger the better. It can be seen that ultimate tensile strength is largely influenced by thickness of material, then by carbon percentage of material and then by electrode diameter. Same result can be seen in main effect plot for SN ratio, based on above analysis recommended thickness of material, carbon percentage and electrode diameter for maximum ultimate tensile strength are 10 mm, 0.4% and 2.6 mm respectively. Fig-2 shows that graph between SN ratio, thickness of material, carbon percentage, and electrode diameter. As shown in figure in the first graph SN ratio is maximum at 10mm thickness of material, in second graph SN ratio is maximum at 0.4% carbon percentage of material and in third graph SN ratio is maximum at 2.6mm electrode diameter.

4.1 Analysis of variance (ANOVA)

The purpose of the ANOVA [7-9] is to investigate which welding process parameter has significantly affected the tensile strength. The results of ANOVA are shown in Table 5. This is accomplished by separating the total variability of the S/N Ratios, which is measured by the sum of squared deviations from the total mean of the S/N ratio, into contributions by each welding process parameter and the error. The percentage contribution by each of the welding process parameters in the total sum of the squared

Table 3: Experiment layout of L9 Orthogonal Array

S.N o.	Thick ness of plates (mm)	Carbo n% of materi al	Electrod e Diamete r (mm)	Ultimate tensile strength (kg)
1.	8	0.4	2.6	5000
2.	8	0.6	2.8	3800
3.	8	0.8	3.6	2600
4.	10	0.4	2.8	6100
5.	10	0.6	3.6	6000
6.	10	0.8	2.6	6000
7.	12	0.4	3.6	6500
8.	12	0.6	2.6	6100
9.	12	0.8	2.8	5200

deviations can be used to evaluate the importance of the process parameter change on the quality characteristic.

Table.5.Result of the ANOVA

Source	D F	Seq SS	Adj SS	Adj MS	F	P
Thickne ss of plates(mm)	2	9548 889	9548 889	4774 444	20. 36	0.0 47
Carbon % of material	2	2415 556	2415 556	1207 778	5.1 5	0.1 63
Electro de diamete r(mm)	2	8888 89	8888 89	4444 44	1.9 0	0.3 45
Error	2	4688 89	4688 89	2344 44		
Total	8	1332 2222				

From the ANOVA result, the percentage contribution of the p value of thickness of plates is less than 0.05, compared with the other welding parameters.

4.2 Confirmation tests

Since the optimal level of the process parameters has been selected, the final step is to predict and verify the improvement of the ultimate tensile strength using the optimal setting of the process parameters. The estimated S/N ratios for the ultimate tensile strength using the optimal combination were determined by **Minitab-16 software**. The calculated results are shown in Table 6.

Table 6: Calculated results by Predicted Vs Experimental value

S. No	Thickn ess of materi al (mm)	Carbon Percent age of Materia l	Electr ode Diame ter	Predic ted SN ratio	Experim ental SN ratio
1	10	0.4	2.6	77.78	70.85

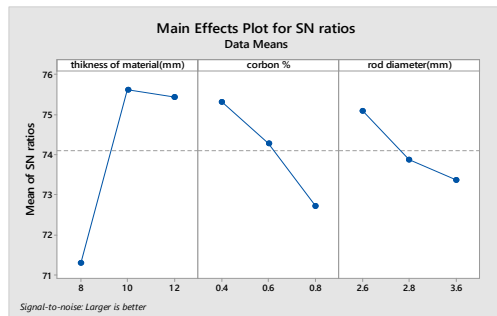


Fig-2: Graph between SN ratio, Thickness of material, Carbon % and Electrode Diameter

Conclusion:

The tensile strength of the mild steel welded plates is measured in the Universal Testing Machine (UTM). Taguchi analysis for optimization of ultimate tensile strength is applied and found to be satisfactory. It has been found that ultimate tensile strength is largely influenced by thickness of material. The optimum setting of selected parameters i.e. thickness of material, carbon percentage of material and electrode diameter are 10mm, 0.4%, 2.6mm respectively. The ultimate tensile strength obtained in above setting of parameters in conformation experiment is 11000 kg which is very large as compared to ultimate tensile strength recorded based on L9 orthogonal array.

References:

[1] Howard Cary B, Modern Welding Technology, (Prentice Hall Inc, Englewood Cliffs, NJ), 1979.

[2] Nadkarni S V, Modern Welding Technology, (Oxford & IBH Publishing Co. Pvt.Ltd, New Delhi), 1988.

[3] Lenin N., Sivakumar M. and Vigneshkumar D. Process Parameter Optimization in ARC Welding of Dissimilar Metals, Thammasat Int. J. Sc. Tech., Vol. 15, No. 3, July-September 2010

[4] S. C. Juang and Y. S. Tarn, Process Parameter Selection for Optimizing the Weld Pool Geometry in the Tungsten Inert Gas Welding of Stainless Steel, Journal of Materials Processing Technology, Vol. 122, pp. 33-37, 2002.

[5] A. Kumar and S. Sundarrajan, Process Parameter Selection for the Optimum Weld Pool Geometry in the TIG Welding of Aluminium Alloy Using Taguchi Method, International Welding Symposium, WE07, 2005.

[6] Y. S. Tarn, H. L. Tsai, S. S. Yeh, Modeling, Optimization and Classification of Weld Quality in TIG Welding, International Journal of Machine Tool and Manufacture, Vol. 39, pp. 1427-1438, 1999.

[7] S. C. Juang and Y. S. Tarn, Process Parameter Selection for Optimizing the Weld Pool Geometry in the Tungsten Inert Gas Welding of Stainless Steel, Journal of Materials Processing Technology, Vol. 122, pp. 33-37, 2002.

[8] A. Kumar and S. Sundarrajan, Process Parameter Selection for the Optimum Weld Pool Geometry in the TIG Welding of Aluminium Alloy Thammasat Int. J. Sc. Tech., Vol. 15, No. 3, July-September 2010

[9] Y. S. Tarn, H. L. Tsai, S. S. Yeh, Modeling, Optimization and Classification of Weld Quality in TIG Welding, International Journal of Machine Tool and Manufacture, Vol. 39, pp. 1427-1438, 1999.

A REVIEW STUDY ON DIGITAL WATERMARKING TECHNIQUES

Vineet Raj Singh Kushwah¹, Sumit Tiwari², Manvendra Gautam³

¹Prof., Dept. of CSE, IPS-CTM, Gwalior(M.P)

²PG Scholar, Dept. of CSE, SRCEM, Banmore, (M.P)

³Asst. Prof., Dept. of CSE, IPS -CTM, Gwalior, (M.P)

Email: vineetkushwah@yahoo.co.in¹, sumitgwalior23@gmail.com², manavgautam2010@gmail.com³

Abstract

With the fast development of web technology and the digital multimedia, the usage of multimedia (audio, video and image etc) has been widely spread. By increasing of these things, intellectual properties can be obtained and reproduced simply. So there is need of our content protection therefore to do so there is a technique like watermarking, which is one of the most effective ways to safeguards the digital properties of our object. This paper reviews various techniques and aspects about digital watermarking.

Index terms: content protection, watermarking, digital properties.

I. INTRODUCTION

Watermarking technique is used for information hiding which is used to conceal proprietary information in digital media as photographs, digital video, digital music etc. The ease with which digital content can be exchanged over the Internet has created copyright infringement issues. Over peer-to-peer networks, copyrighted material can be easily exchanged, and this makes serious concerns to those content providers who produce these digital contents. This paper provides a survey of watermark techniques for files like video, text, images and audio.

II. REVIEW ON DIGITAL WATERMARKING

Digital Watermarking technique [1] means the process to embed the given watermark information

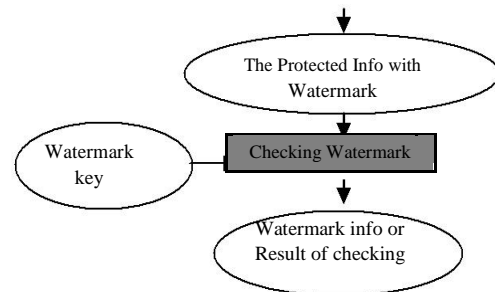
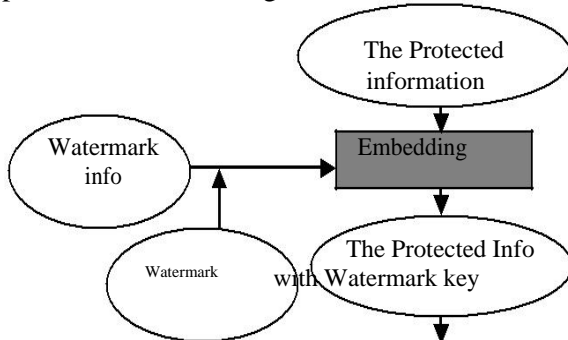


Fig 1: Fundamental Process of digital Watermarking

(Such as symbol, possessory name, signature etc.) into the protective information (such as sound, picture, video) and picking the given watermark information from the protective information, which is not perceived by human perceptual system. Fig.1 depicts the fundamental process of digital watermarking technique. “Ref. [1, 2]” gives enough detail about watermarking requirements and its various type like fragile and robust watermarking.

III. THREE STAGES IN WATERMARKING

A. Generation and Embedding

Pseudo Random Sequence, M- Sequence and Chaotic Sequence are some sequences

employed for generation of watermark [5]. The combination of watermark signal and original image can be seen as embedding process.

B. Distribution and Possible Attacks

The distribution process can be understood as the transmission of the signal through the watermark channel. Possible attacks in the broadcast channel might be accidental or intentional.

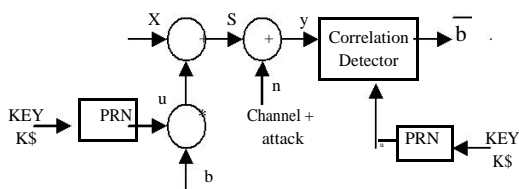
C. Detection

Detection process allows the owner to be identified and provides information to the intended recipient. There are two types of detection: Blind detection and Informed detection.

IV. TEXT WATERMARKING TECHNIQUES

A. Spread Spectrum Technique of Watermarking

Mixing of Watermark bits (b) with PRN (Pseudo Random Noise) generated signal and this signal is inserted in the host signal (X). This PRN signal functions as a secret key. Fig. 2 shows such mechanism [3].



The signal of watermarked amplitude is highly less than 1% of the host's amplitude. This specific PRN signal can be later on detected by match filter or correlation receiver.

B. Line-Shift Coding

Here each even line is slightly shifted down or according to the bit value in the payload [7]. The corresponding line is shifted up, if the bit is one; otherwise, the line is shifted down. The odd lines are act as control lines and used at decoding.

In the context of standardization activities, objective performance metrics are needed to evaluate whether one of the established are emerging watermarking technique is superior to

Fig 3: Example of line-shift coding. The second line has been shifted up by 0.085 mm

C. Word-Shift Coding

Here we divide each line into group of words. Each group has a enough number of characters. Then, According to the bit value in the payload, each even group is shifted to the right or the left. The odd groups are treated as references for measuring and comparing the distances between the groups at decoding [8].

D. Feature Coding

Here certain text features (e.g., vertical end lines) are changed in a specific way to encode the ones and zeros of the payloads. To detect Watermark the original document is compared with the watermarked document [8].

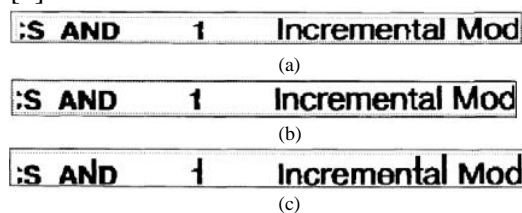


Fig 4: Examples for Feature Coding

In Fig. 4 feature coding is performed on a portion of text from a journal table of contents. In (a), no coding is applied. In (b), feature coding has been done to select characters. In (c), the feature coding has been exaggerated to display feature alterations [8].

V. IMAGE WATERMARKING TECHNIQUES

Images can be represented as pixels in terms of frequencies in transform domain or spatial domain. We use reversible transforms like Discrete Cosine Transform (DCT), Discrete Wavelet Transform (DWT), or Discrete Fourier Transform (DFT) [6] to transfer an image to its frequency representation. Watermarks can be embedded within images by changing these values, i.e. the transform domain coefficients [9] or pixel values.

A. DCT Domain Watermarking

The high frequency components are watermarked in frequency domain. The main steps are

- 1) Divide the image into non-overlapping blocks of 8x8
- 2) Apply forward DCT to each of these blocks

- 3) Apply some block selection criteria (e.g. HVS)
 - 4) Apply coefficient selection criteria (e.g. highest)
 - 5) Embed watermark by modifying the selected coefficients.
 - 6) Apply inverse DCT transform on each block
- B. DWT Domain Watermarking*

Here the underlying concept is the same as DCT however, the process to transform the image into its transform domain changes and in this way the resulting coefficients comes different. Wavelet transforms use wavelet filters like Daubechies Orthogonal Filters, Haar Wavelet Filter and Daubechies Bi-Orthogonal Filters to transform the image. Each of these filters breaks the image into many frequencies. Single level decomposition yields four frequency representations of an image like LL, HH, LL, HH subbands.

C. DFT Domain Watermarking

DFT domain is favorite choice of researches because it provides robustness against geometric attacks like translation, rotation, cropping, scaling etc. There are two types of DFT based watermark embedding techniques. In first technique watermark is directly embedded and another technique is template based embedding. In direct embedding watermark is embedded by changing the phase information within the DFT.

A template is a structure which is used in the DFT domain to judge the transformation factor. First a transformation is made in image then to resynchronize the image this template is searched, and then employ the detector to extract the embedded spread spectrum watermark.

VI. AUDIO WATERMARKING TECHNIQUES

The portion of data that can be embedded [4,5] into audio is considerably low than amount that can be embedded in images, as audio signal has a dimension less than two-dimensional image files. Hiding additional information into audio sequence is a more complex than images, due to dynamic supremacy of HVS than HAS.

A. Least Significant Bit Coding

This simple approach in watermarking audio sequences is to embed watermark data by chnging certain LSBs of the digital audio stream with low amplitude.

B. Phase coding

The basic idea is to divide the original audio stream into blocks and insert the whole watermark data sequence into the phase spectrum of the first block.

C. Quantization Method

A scalar quantization scheme quantizes a sample value x and assign new value to the sample x based on the quantized sample value. In other words, the watermarked sample value y is represented as follows:

$$y = \begin{cases} q(x, D) + D / 4 & \text{if } b = 1, \\ q(x, D) - D / 4 & \text{otherwise} \end{cases} \quad (1)$$

In (1) $q(\cdot)$ is a quantization function and D is a quantization step. A quantization function $q(x)$ is given as $q(x, D) = [x / D].D$, where $[x]$ rounds to the nearest integer of x . A sample value x is quantized to $q(x, D)$. Let $q(x, D)$ denote anchor. If the watermarking bit b is 1, the anchor is moved. Otherwise, the cross (\times) stands for the watermarking bit 0.

D. Spread-Spectrum Method

This scheme [3] spreads pseudo-random sequence across the audio signal. The wideband noise can be spread into either transform-domain signal or time-domain signal. Frequently used transforms include DWT, DFT, and DCT.

E. Replica Method

Original signal can be used as an audio watermark. Echo hiding is a nice example. Replica modulation also embeds part of the original signal in frequency domain as a watermark.

Echo Hiding

The Echo hiding inserts data into an original audio signal by introducing an echo in the time domain. For example, a single echo is added in Fig 5. However, multiple echoes can be added (Bender *et al.* 1996). Binary messages are embedded by echoing the original signal with one or two delays, either a d_0 sample delay or a d_1 sample delay. Extraction of the embedded message involves the detection of delay d . that is a two-dimensional signal and was transformed in the DCT domain, the new bit rate is compared with the original and, depending on the bit rate; the original DCT block is selected.

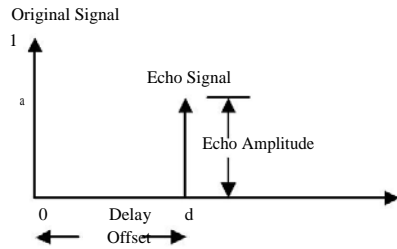


Fig 5: Kernels of Echo Hiding

VII. VIDEO WATERMARKING TECHNIQUES

A. Embedding in the spatial domain

Spatial domain [4, 5] embedding is one of the characteristics of JAWS video watermarking algorithm by Kalker et al. It is used to embed watermark pattern W in the spatial domain by altering intensity values to guarantee robustness for color conversions. If the spatial correlation value C_T goes more than a certain threshold τ , the watermark is found otherwise no watermark. This shows the embedding of one-bit pay load.

B. Embedding in the transformation domain

Transformation domain [5] embedding can be analogous to image watermarking in the transformation domain as seen in the SysCoP video watermarking algorithm by Busch et al. Real-time-capable implementations of the inverse DCT and DCT are used. The SysCoP algorithm is run on a digital signal processor (DSP) board. If the block comprises edges or textures visual quality can also be increased. The blocks which are found plain areas, they are watermarked with lower strength. Robustness against MPEG2 compression is accomplished by maximum redundancy. Almost watermark procedure is deployed to all blocks of a video frame.

C. Embedding in the compressed domain

A method was proposed by Girod and Hartung that is used to embed the information in the compressed domain also and getting back the information from the decompressed domain. The general diagram of the that method is shown in Fig 6. DCT coefficients of the MPEG 2 bit stream are altered only. Before modification, MPEG 2 compression operations are inverted. Hence, After adding the watermark, this scheme is really embedded in the transformation domain,

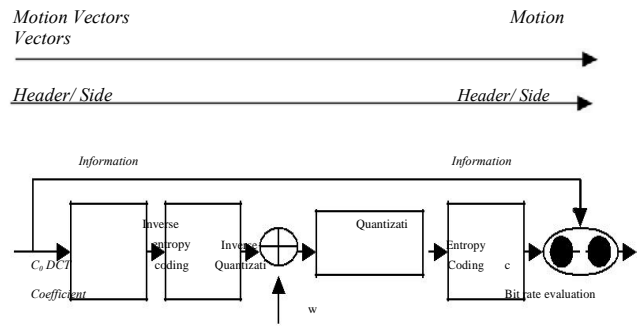


Fig 7: The Block diagram of compressed video marking

VIII. CONCLUSION

This paper reviews many techniques for watermarking data files like audio, text, image and video. So, we can conclude that watermarking is a significant approach for protection of copyrights on digital properties. Different watermarking techniques are used for various types of requirements. However, it is difficult to satisfy all the requirements at the same time. So, benchmark is used to compare the performance of different watermarking systems and evaluate.

REFERENCES

- [1] Jian Liu, Xiangjian He; "A Review Study on Digital Watermarking", Information and Communication Technologies, 2005. ICICT 2005. First International Conference, Page(s):337 – 341, 27-28 Aug. 2005.
- [2] Cox, I.J., M.L. Miller, and J.A. Bloom, "Digital Watermarking.", 1st edition 2001, San Francisco: Morgan Kaufmann Publisher.
- [3] I.J. Cox, J. Kilian. F. T. Leighton and T. Shamoan, "Secure spread spectrum watermarking for multimedia." IEEE Transactions on Image Processing, Vol. 6, No. 12, pp. 1673-1687, Dec. 1997.
- [4] Juergen Seitz, University of Cooperative Education Heidenheim, Germany, "Digital Watermarking for Digital Media", 1st edition May 2005, Information Science Publishing.
- [5] Michael Arnold, Martin Schmucker, Stephen D.Wolthusen, "Techniques and Applications of Digital Watermarking and Content Protection", 1st edition July 2003, Artech House.
- [6] Potdar V.M., Han, S., Chang, E.; "A survey of digital image watermarking techniques", Industrial Informatics, 2005. INDIN '05.

- 2005 3rd IEEE International Conference, Page(s):709 – 716, 10-12 Aug 2005.
- [7] Micic, A.; Radenkovic, D.; Nikolic, S.; “Autentification of Text Documents Using Digital Watermarking”, Telecommunications in Modern Satellite, Cable and Broadcasting Services, 2005. 7th International Conference on Volume 2, Page(s):503 – 505, 28-30 Sept. 2005.
- [8] Brassil, J.T.; Low, S.; Maxemchuk, N.F.; O’Gorman, L.; “Electronic marking and identification techniques to discourage document copying”, Selected Areas in Communications, IEEE Journal on Volume 13, Issue 8, Oct. 1995 Page(s):1495 – 1504
- [9] Guan-Ming Su, "An Overview of Transparent and Robust Digital Image Watermarking". Available online at www.watermarkingworld.org/LWMLArchive/0504/pdf0000.pdf

A REVIEW OF INNOVATIVE RURAL ROAD CONSTRUCTION TECHNIQUES

Deepak Tiwari¹, Manoj Sharma², A.S.Trivedi³

¹PG Scholar, Civil Engineering, IPS-CTM, Gwalior (M.P)

²Asst prof, Civil Engineering, IPS-CTM, Gwalior (M.P)

³Prof, Civil Engineering IPS-CTM, Gwalior (M.P)

Email: deeptiwari6200@gmail.com¹, manojsharma623@ymail.com²
ashnriju@rediff.com³

Abstract

Rural Roads Connectivity is one of the key for rural development, as it promotes access to economic and social services, generating increased agricultural income and employment. While building rural roads, the provisions based on the parameters that affect the sustainability at a minimum cost. The conventional methods and specifications tend to recommend technology and materials, however difficult and distance away they may be, which normally result in higher cost of construction. This call for introduction innovative approaches in rural roads building for achieving cost-effectiveness. Though such methods and technologies were tried world over, they could not become popular in India, due to procedural constraints and lack of awareness. An attempt is made to bring in together innovative technologies and discuss their positive impacts so as to convince the field engineers in adopting such technologies at places found effective.

INTRODUCTION

About 800 million people of India live in nearly 3 lakh villages scattered all over the country. Roads provide the means to bring the rural population on to the main stream. The State and Central level, through different programs, about 50% of habitations in the country are still not connected by all- weather roads. As a Poverty reduction strategy, PMGY was launched as a 100% centrally funded programme for Rural Roads Development in India. The rural connectivity is expected to have many positive impacts on economy, agricultural, employment and social services to rural masses. India is distinguished for its geographical diversities with mountains, hills, rivers terrains, forest, wet lands, deserts and scattered habitations in remote areas. Also, there exists a wide range in the sub-grade soil types, rainfall, traffic pattern and availability of construction materials. These natural barriers create problems for developing a

standard uniform technique to serve the requirements at all the sites. This requires adoption of different technologies based on site specific conditions. For the construction of Rural Roads, Indian Roads Congress has brought out Rural Road Manual IRC SP: 20-2002 for design and construction. The design is based on the CBR value of the soil sub-grade and the 10 years projected cumulative traffic with an assumed 8% traffic growth per year. Based on this concept, normally two layers of WBM with 75 mm thickness is laid over the granular sub-base with suitable material having minimum 16% CBR. However, there are situations in many states where the prescribed standards are not available at normal leads resulting in longer haulage and higher costs. If the locally available materials, including marginal and industrial waste materials are utilized, it could be possible to reduce the cost of road construction. Several types of new materials are tried to establish the

efficacy of new materials in road construction. However, the use of new materials and technologies is not becoming popular owing to certain procedural constraints as well as lack of awareness and therefore appropriate steps may have to be taken for popularizing the new technologies for building better rural roads with less cost. Adoption of such technique may also result in the conservation of natural resources, energy environment

2. SOIL IMPROVEMENT TECHNIQUE

One of the proven technologies for the use of local soil and marginal aggregates is stabilization. The stabilization can be mechanical or chemical and several types of stabilizing agents have proved to be suitable under different conditions of soil and environment. The soil stabilization techniques include:

- Stabilization with lime.
- Stabilization with cement.
- Stabilization with a combination of lime and cement

Specifications for soil stabilization are included in both MoRT&H and MoRD book of specifications their adoption is not getting popular, due to problems associated in attaining homogeneity of soil-stabilizer mix in the field and achieving the desired results. The only constraint in the use of the above techniques lies on the procedures adopted in the field. It is possible to popularize the use of stabilization techniques through appropriate training and capacity building of the field engineers. Further, development of low end technology equipment, for use in the rural roads also facilitates wider use of these methods.

In addition to the above, several methods are being tried with the use of industrial waste by products in road building. The following are some of the important materials which have proved good.

- Fly Ash for the construction of the embankments and stabilization of sub-base and base-courses.
- Steel and copper slag for the construction of sub-base and base course
- Marble dust in sub-grade and sub base.

Though the construction of different elements of the road with Fly Ash has been successfully implemented, the use of other materials is not so widely adopted except for in- plant roads. However, construction technologies with the use of such materials can also be successfully adopted, if the field engineers are properly trained.

Studies were carried out on the use of waste materials like rice husk ash and lime sludge. These materials, if left un-used, may affect the surroundings and also create problem for their disposal. Use of those waste materials in road construction can alleviate the problem of their disposal to great extent. In India, studies were conducted at CRRI, IIT Roorkee and several other places for their use in stabilizing the soil. The results indicated that their usage has great impact on the improvement of soil properties. The studies suggested that they are very useful for stabilizing clayey soils. The summary of the results indicate the following.

- Improve Atterberg limits to make soil suitable for road building.
- Increase the unconfined compressive strength of soil as well as CBR

3. Innovation in Soil Improvement

Recently several environmental friendly enzymes have come into the market such Fujibeton, Terrazyme and Renolith. These product indicates minimization, elimination of the use of aggregate. Such materials can also be tried in the rural roads construction after proving their efficacy in the Indian conditions.

4. Soil Stabilizing Agent

The Fujibeton material is climatically stable material and suitable for stabilization of all types of soils. The product is an inorganic polymer that chemically binds with all compounds, where blended with ordinary Portland cement in 1 to 5% by weight of OPC. The blended mix which is used for stabilization of soil that improves the properties of soil.

The design concept is based on the optimization of agent mix for stabilization based on unconfined compressive strength results, determined on the given soil for different proportions of soil-Fujibeton mix and

calculation of the thickness of the stabilization layer based on design CBR test, wheel load and volume of traffic. The top layer of the pavement should be covered with 4 to 6 cm asphalt concrete.

Soil agent improves CBR of the sub-grade and does not create shrinkage cracks and is highly effective for clayey/soils. With Fujibeton, a high dry density is obtained with minor compaction. Small equipment like tractor mounted equipment are sufficient. Also, this technology does not require skilled manpower for road construction. This technology is efficient and economical for construction of embankment and sub-grade & sub-base course.

3.1 Terrazyme is a natural, non-toxic; environmentally safe, bio-enzyme product that

Technologies in Rural Roads Construction

There are several other techniques that can be adopted in conditions of low bearing capacity soils, marshy lands and location with drainage problems such as the use of geo- textiles. Several types of geo-textiles including synthetic, jute coir etc. are proved to give good results and provide cost effectiveness for rural roads.

Use of Jute Geo-textile

Jute Geo-textile is a kind of natural technical textile laid in or on soil to improve its engineering properties. It is made out of yarns obtained from the jute plant. Jute Geo Textiles have high moisture absorption, high initial tensile strength, bio- degradable and improved soil structure on degradation. The basic functions of JGT are separation, filtration, drainage and initial. improves engineering qualities of soil reduces ruts and potholes resulting in more durable and longer lasting roads. The function of agent is to minimize absorbed water in the soil for maximum compaction, which decreases the swelling capacity of the soil particles and reduces permeability. The application of agent enhances weather resistance and increases load-bearing capacity of soils especially in clayey/soils. This will provide cost effectiveness both in the initial construction cost and maintenance cost.

Advantages of Terrazyme Technology

Improvement in soil CBR.

Minimum loss of gravel due to erosion or abrasion by the traffic preserving original transverse section of slopes.

This technology is used in strengthening of layers of un-surfaced roads, in base layers and sub-base layers covered with asphalt material. Among the soil materials stabilized by Terrazyme are sandy clay, silty clay, sandy silt, plastic and non-plastic clay, sandy loam, fine loam, loam mixed with clay.

3.2 Soil Cement Renolith Stabilization Technique:

Renolith is polymer based chemical, which is environmentally friendly and which facilitates the bonding of soil particles Soil-cement with agent has a high modulus of elasticity and can disperse the wheel loads very effectively. It is a semi-rigid material. A feature of this technology is that it requires very little amount of aggregate, which is useful at places where the material haulage is more. The use of agent, when used in soil stabilization with cement, gives strong and durable base. This type of construction does not require surfacing for low volume roads, since the base course is stabilized.

reinforcement. It is environment friendly. Jute Geo- textiles can be more effective, eco-friendly and economical if used judiciously and jointly with other measures. Based on the experiences of the use of Jute Geo Textiles, MoRD in collaboration with JMDC is implementing a pilot project in five States covering a length of about 58 Km under different soil and environmental conditions

This project is taken up with different types of Jute Geo –Textile and placement at different levels. The post construction performance monitoring is expected to give valuable data for arriving at standards and specifications of this technique which helps for wider application. The project is in progress and the results are expected shortly.

4.1 Flexible-Concrete Pavement Technology
IIT has developed a new technology for low cost cement concrete road construction, which has proved to be suitable in place of conventional Cement concrete roads for low volume traffic. Even though the initial cost of flexible-concrete road is high compared to cost of conventional flexible pavement, the life cycle cost with maintenance costs over a period of 15-25 years is less compared to the conventional one. The technology consists of placing a form work of plastic cells 150 x 150mm and 100mm deep over the prepared foundation of road and placing zero slump concrete in the cells and compacting with road roller/ plate compactor / earth rammer. On curing, a flexible-concrete pavement is obtained which will not wear even under iron tired carts if aggregates of good quality are used. A model road has already been constructed in a village close to Kharagpur using the technology IITGP-Road. Experimentation through pilot project for the IITGP-Road technology is being tried in the construction of the rural roads under PMGSY, so as to enable standardization and popularization of this cost effective solution.

Case Studies in India:

- length of roads around 1000 m in various stretches were constructed using waste plastic as an additive in bituminous mix under the scheme “1500 km Plastic Tar Road”, and found that, the performance of all the road stretches are satisfactory.
- The performance of the road stretches constructed using waste plastic in Karnataka is also found to be satisfactory.

The construction of roads using Waste Plastic in the above states is based on the guidelines developed by Bangalore University. standard specifications are not available on the use of waste Plastic in Bituminous road Construction. In this regard, IRC was specially requested by NRRDA for the preparation of such Guidelines for enabling the construction of Rural Roads under PMGSY using Waste Plastic. In order to facilitate the development of Guidelines on this, an Expert Group has been appointed by NRRDA for preparation of interim guidelines for the use

of Waste plastic which will be sent to IRC for approval and releasing as IRC guidelines.

Impacts of Innovative Technologies

The stabilization of soil with Enzyme based stabilizers like Fujibeton, Terrazyme and Renolith, can eliminate the need for the use of aggregate material in base course resulting in conservation of material. This results in reduction .

The noteworthy feature of soil-Cement-Renolith Stabilization that it requires very little

4.2 Use of waster plastic Blended Bitumen

To improve the performance of bituminous mixed used in the surfacing course of roads. the used of re-cycled plastic, mainly polyethylene, in the manufacture of blended indicated reduced permanent deformation in the form of rutting and reduced low temperature cracking of the pavement surfacing. Laboratory studies were carried out at the Centre for Transportation Engineering of Bangalore University, in which the plastic was used as an additive with heated bitumen in different proportions (ranging from zero to 15% by weight of bitumen) The results of the laboratory investigations indicated that, the addition of processed plastic of about 7.8% by weight of bitumen, helps in substantially improving the stability, strength, and other desirable properties of bituminous concrete mix, even under adverse water-logging conditions. The additions of 9.0% by weight of processed plastic for the preparation of modified bitumen results in a saving of 0.5% bitumen by weight of the mix or about 8.5% bitumen per cubic meter of BC mix in the cost of construction. A typical analysis for saving of cost in terms of material, machinery and labor for two layers of WBM (75 mm each) and 3.75 m carriageway indicate a saving of about Rs. 8.0 lakhs with medium lead.

It Is not only the reduction of cost, but the real interesting part of this is the conservation of natural resources and energy along with preservation of the environment, which gives long way, if such aggregate free construction of rural roads are encouraged and popularized

CONCLUSION

From the above discussions, the following conclusions can be drawn:

Fujibeton can be used to improve CBR for the sub-grades by about 2.6 times. Simple tractor mounted agriculture equipment can be employed for construction and Economy in construction when aggregates are to be brought from far off distance as well as due to reduced thickness of sub base / base course.

Terrazyme increases CBR of soil sub-grade by more than 100%. Impedes widespread occurrence of dust from loose fine material in the surface of the soil roadways and reduces cost of construction by 15-20%. The roads constructed using Terrazyme minimize the material loss of gravel from erosion or abrasion by the traffic on the soil roadways preserving original transverse section and slopes and impedes widespread occurrence of dust from loose fine material in the surface of the soil roadways.

amount of aggregate, performs with increased life and reduced maintenance cost provide a good base for the field Engineers to experiment the construction of unsealed roads in rural areas and also in localities where aggregate are not available in normal leads. The Jute Geo-textile strengthens the soil sub-grade by preventing intermixing of sub-grade and sub-base by acting as a separation layer and further it prevents migration of fines of a sub-grade by acting as a filtration materials. By the pilot project taken up under PMGSY, it is found that there is cost saving of about 18% in road construction. The IITGP-ROAD technology needs to be studied further the initial cost of Cement Concrete Pavement is at par with the conventional pavement, it is lower than the conventional flexible pavement if maintenance cost is also considered whose bitumen top is to be renewed every 10 years at a cost of over 8 lakhs. The use of modified bitumen with the addition of processed waste plastic of about 10.0% by weight of bitumen helps in substantially improving the stability, strength, fatigue life and other desirable properties of bituminous concrete

mix, resulting which improves the longevity and pavement performance with marginal saving in bitumen usage.

The use of new materials and technologies is not becoming popular in our country mainly due to lack of awareness. Failure to instill confidence in the field engineers by addressing their problems can be another reasons, the third being non-availability of suitable standard equipment.

During the implementation of such Projects the field engineers are to be taken into confidence and need to be involved right from Project Preparation. All technical and implementation processes are to be meticulously documented which become handy in the dissemination process for exposing more field engineers to the technologies. This will instill confidence among them and large scale adoption of these technologies would become possible. These projects also bring out the cost effectiveness and conservation of natural resources that may lead to environmental preservation in the long run.

REFERENCES

1. Andradý A. L. and Neal M. A. 2009. Applications and societal benefits of plastics. *Philosophical Transactions of the Royal Society, B*, 364: pp.1977 – 1984
2. Dr Satish Chandra, Shiv Kumar & Rajesh Kumar Anand, "Soil Stabilization with Rice Husk Ash and lime Sludge", *India Highways, Indian Roads Congress*, vol33 No. 5, May 2005, pp.87- 98
3. Falorca I. M. C. F. G. and Pinto M. I. M. 2011. Effect of short, randomly distributed polypropylene microfibers on shear strength behaviour of soils. *Geosynthetics International Vol18 No.1*, pp. 2–11.
4. Gianni A.K. Modi, A.J., "Bio Enzymatic Soil Stabilizers for Construction of Rural Roads", *International Seminar on Sustainable Development in Road*

- Transport, New Delhi-India p p 8-10, November 2001.
5. Ibraim E. and Fourmont S. 2006. Behaviour of sand reinforced with fibres. Geotechnical Symposium on Soil Stress-Strain Behavior: Measurement, Modeling and Analysis, Roma, pp.807–818
 6. IRC:SP:20-2002. “Rural Roads Manual”, Indian Roads Congress.
 7. Punith, V.S. and Veeraraghavan, A., “Laboratory Fatigue Studies on Bituminous concrete Mixed Utilizing Waster Sherdded Plastic Modifier”, Proceedings of 21st ARRB Transport Research (ARRB) and 11th Road Engineering Association and Australia (REAAA) Conference, Cairns, Australia, May pp.19-23, 2003
 8. Raju, G.V.R.P., Chandrasekhar B. P., Kumar R.R.P. and Mariyanna G. “Strength Characteristics of Expansive Soils Stabilized with Lime and Rice Husk Ash”, Proceeding of the National Seminar on Road Transportation; Issues & Strategies, Patiala, India (1998), pp-20-29.
 9. Report on “Demonstration Project for Aggregate-Free Pavement Technology using Fujibeton for Rural Road Construction”, NCCBM, New Delhi, India.
 10. Report on “Demonstration Project using Soil-Cement – RENOLITH stabilization technique” by PWD Rajasthan, India.
 11. Santoni R. L., Tingle J. S. and Webster S. L. 2001. Engineering Properties of Sand-Fibre Mixtures for Road Construction, Journal of Geotechnical Engineering, ASCE Vol127 IssueNo.3, pp.258–268
 12. Teiborland L. Rynathiang, M. Mazumdar and B.B. Pandey, 2005. IIT Kharagpur, “Structural Behaviour of Cast n Situ Concrete Block Pavement”, Journal of Transportation Engineering, Vol.131, Issue 9, pp.662-668 .
 13. “Use of Jute Geo-textile as a separator-cum reinforcement for rural roads under PMGSY on an Experimental basis” TECHFAB India, Mumbai.
 14. Zornberg J. G. 2002. Discrete framework for limit equilibrium analysis of fiber reinforced soil. Géotechnique Vol52, Issue No.8, pp.593–604.

EFFECT OF RADIAL VISCOSITY VARIATION ON NON-NEWTONIAN FLOW OF BLOOD IN AN OVERLAPPING STENOSED ARTERY

Pushkar Singh¹, Aditi Singh², S. P. Singh³

^{1,2}P.G Scholar, Department of Mathematics, D.E.I., Dayalbagh, Agra (U.P)

³Asst. Prof., Department of Mathematics, D.E.I., Dayalbagh, Agra, (U.P)

Email: pushkar19121992@gmail.com¹, aditi.dei2014@gmail.com²
shail.dei@gmail.com³

Abstract

The proposed work involves the thorough investigation of the Non-Newtonian flow of blood through an overlapping stenosed artery. Herschel-Bulkley equation has been taken to represent the Non-Newtonian behavior of blood. The study shows the effect of radial viscosity variation on various parameters of blood flow. The expressions for flow rate, resistance to flow and wall shear stress has been obtained analytically. The variations of these flow parameters are shown with the help of graphs. It is found that various flow characteristics are affected by the presence of overlapping stenosis and radial variation of blood viscosity.

Keywords: Blood flow, Blood viscosity, Overlapping stenosis, Herschel-Bulkley fluid, Flow rate, Resistance to flow, Wall shear stress.

I. INTRODUCTION

Healthcare problems are apparently concerned by the people in these days. For over centuries, cardiovascular diseases have been noticed as one of major illnesses where numerous people suffer from them. These diseases are a major cause for deaths in this world. Among the cardiovascular disease, the familiar one is atherosclerosis. If the stenosis is present in the artery, normal blood flow is disturbed. The intimal thickening of stenosed artery was understood as an early process in the beginning of atherosclerosis. This may be caused by unhealthy living conditions such as exposure to tobacco smoke, lack of physical activity and improper dietary habits. It is always followed by the serious changes in blood flow, pressure distribution, wall shear stress and flow resistance, thus leading to the importance of study of blood flow through stenosed artery. A Newtonian fluids, by definition is one in which the coefficient of viscosity is constant at all rates of shear. However, the fluids which do not obey the linear relationship between shear stress and strain rate are called as Non-Newtonian fluids. In few

studies (Young [15]), the behavior of the blood has been considered as a Newtonian fluid. However, it may be noted that the blood does not behave as a Newtonian fluid under certain conditions. It has been observed that whole blood; behave as Newtonian at high shear rate while at low shear rates and in small diameter arteries (Cokelet et. al [5], Charm and Kurland [3]), it exhibits Non-Newtonian behavior.

Further (Scott-Blair and Spanner [1]) reported that blood obeys the Casson equation only in a limited range, not at very high and very low shear rates. It is observed that the Casson fluid model can be used for moderate shear rates in smaller diameter tubes whereas the Herschel-Bulkley fluid model can be used at still lower shear rate flow in very narrow arteries where the yield stress is high. The Herschel-Bulkley equation contains one more parameter than the Casson equation does; it would be expected that more detailed information about the blood properties can be obtained by the use of the Herschel-Bulkley equation. Further, in small diameter tubes blood behaves like a Herschel-Bulkley fluid rather than Power law and Bingham fluids

(Chaturani and Samy [4]). However, all these investigations considered the effect of single stenosis but, the constrictions may develop in series (multiple stenoses) or may be of irregular shapes or overlapping. (Chakravarthy and Mandal [2]) studied effects of overlapping stenosis on arterial flow problem analytically by assuming the pressure variation only along the axis of tube. (Layek et al [8]) investigated the effects of overlapping stenosis on flow characteristics considering the pressure variation in both the radial and axial directions of the arterial segment under consideration and (Srivastava et al. [12]) studies the blood flow through an overlapping stenoses assuming that the flowing blood is represented by two layered macroscopic two-phase model . (Misra et al.[9]) developed a Herschel-Bulkley fluid model and observed that the resistance to flow and skin friction increase as stenosis height increases. (Shah[11]) studied the effect of Non-Newtonian behavior of blood flow through a radially non-symmetric multiple stenosis artery using Herschel-Bulkley fluid model and provided the results for the resistance to flow, apparent viscosity and the wall shear stress through graphical representations.

The effects of peripheral layer viscosity on physiological characteristics of blood flow through the artery with mild stenosis studied by (Shukla et al. [13]). It has been shown that the resistance to flow and wall shear stress decrease as the peripheral layer viscosity decrease. The effects of stenosis on resistance to flow and wall shear stress in an artery by considering the blood as non-Newtonian fluid showed by (Shukla et al. [14]). (Gupta.S et al. [6]) investigated the effects of stenosis and radial variation of viscosity on flow characteristics of blood considering laminar, incompressible and Non-Newtonian flow of blood using Power law fluid model. (Jain.N et al. [7]) observed various flow characteristics of blood and effect of parameters of stenosis using Herschel-Bulkley Non-Newtonian fluid model considering steady, laminar, one dimensional flow of blood through an axially non-symmetric but the radially symmetric atherosclerotic artery.

An attempt is made in the present investigation to explore the effect of radial variation of viscosity on the blood flow through an

overlapping stenosis treating blood as Herschel-Bulkley fluid.

II. MATHEMATICAL FORMULATION

Consider the axisymmetric laminar and incompressible, steady, fully-developed, one dimensional flow of blood through a circular cylindrical tube under a constant pressure gradient with an overlapping constriction specified at the position as shown in Fig. 1. In this analysis, it is assumed that the stenosis developed in the arterial wall in an axially symmetric depends upon the axial distance z and the height of its growth. There is no external force acting on the flowing blood. Also, viscosity of blood varies along the radial direction and there exists a radial decrease in blood viscosity i.e., it is maximum at the axis of the artery and minimum near the wall. The geometry of the stenosis which is assumed to be manifested in the arterial segment is described Chakravarty and Mandal[2] as

$$\frac{R(z)}{R_0} = 1 - \frac{3\delta}{2R_0l_0^4} [11(z-d)l_0^3 - 47(z-d)^2l_0^2 + 72(z-d)^3l_0 - 36(z-d)^4] \quad , \quad d \leq z \leq d + l_0 \quad \dots(1)$$

$$= 1 \quad , \text{ otherwise} \quad \dots(2)$$

where $R(z)$ and R_0 are the radius of the tube with and without stenosis, respectively, R_p is the radius of the plug flow region, l_0 is the length of the stenosis and d indicates its location, δ is the maximum projection (maximum height) of the stenosis into the lumen, appears at two locations: $z = d + \frac{1}{6}l_0$ and $z = d + \frac{5}{6}l_0$. The stenosis height at $z = d + \frac{1}{2}l_0$ from origin, called critical height, is $\frac{3\delta}{4}$.

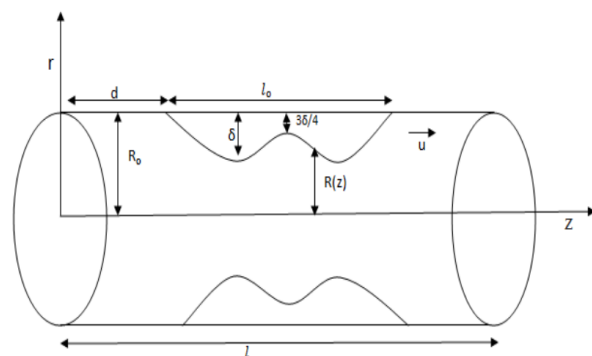


Fig. 1: The flow geometry of an arterial overlapping stenosis

The Navier-Stokes equation is given by

$$-\frac{\partial p}{\partial z} + \frac{1}{r} \frac{\partial}{\partial r} (r\tau) = 0 \quad \dots(3)$$

where r and z be the radial and axial coordinates respectively, p is the pressure and τ be the shear stress.

The constitutive equation for Herschel-Bulkley fluid is given by

$$\tau = \mu(r) \left(-\frac{\partial u}{\partial r}\right)^n + \tau_0, \quad \tau \geq \tau_0 \quad \dots(4)$$

$$\frac{\partial u}{\partial r} = 0, \quad \tau < \tau_0 \quad \dots(5)$$

where τ_0 be the yield stress, $\mu(r)$ be the viscosity coefficient of blood and $\frac{\partial u}{\partial r}$ be the shear rate.

The boundary conditions pertaining to the problem are :

$$u = 0 \text{ at } r = R(z) \text{ and} \quad \dots(6)$$

$$\tau \text{ is finite at } r = 0 \quad \dots(7)$$

The viscosity variation along the radial direction is linear and is as follows:

$$\mu(r) = \mu_0 \left(1 - q \frac{r}{R_0}\right) \quad \dots(8)$$

where μ_0 is the viscosity of the fluid at $r = 0$ and $q (<< 1)$ is a constant parameter.

III. ANALYTICAL SOLUTION

The equation of motion describing one dimensional flow of blood treating it as Herschel-Bulkley fluid is

$$-\frac{\partial p}{\partial z} + \frac{1}{r} \frac{\partial}{\partial r} \left[r \left\{ \mu(r) \left(-\frac{\partial u}{\partial r}\right)^n + \tau_0 \right\} \right] = 0 \quad \dots(9)$$

To obtain the expression for velocity profiles, i.e., integrating equation (9) w.r.t. r on both sides under boundary condition (7)

$$u = \frac{-1}{2^{1/n}} \int \left(\frac{r \frac{\partial p}{\partial z} - 2\tau_0}{\mu(r)} \right)^{1/n} dr \quad \dots(10)$$

The **flux** Q is given by

$$Q = \int_0^{R(z)} 2\pi r u dr \quad \dots(11)$$

Now, substituting equations (10) and (8) in (11), we obtain

$$Q = \frac{\pi}{(2\mu_0)^{1/n}} \int_0^{R(z)} r^2 \left\{ \frac{r \frac{\partial p}{\partial z} - 2\tau_0}{\left(1 - q \frac{r}{R_0}\right)} \right\}^{1/n} dr \quad \dots(12)$$

Equation (12) can be restated as

$$\frac{\partial p}{\partial z} = 2\mu_0 \left(\frac{Q}{\pi I_{R(z)}} \right)^n \quad \dots(13)$$

$$\text{Where } I_{R(z)} = \int_0^{R(z)} r^2 \left\{ \frac{r \frac{\partial p}{\partial z} - 2\tau_0}{\left(1 - q \frac{r}{R_0}\right)} \right\}^{1/n} dr \quad \dots(14)$$

To obtain **pressure drop** (Δp), we use the following conditions :

$$p = p_0 \text{ at } z = 0 \text{ and} \quad \dots(15)$$

$$p = p_L \text{ at } z = L \quad \dots(16)$$

Integrating equation (13) w.r.t z on both sides and applying boundary conditions (15) and (16), we obtain

$$\Delta p = p_l - p_0 = \int_0^L \frac{\partial p}{\partial z} dz = 2\mu_0 \left(\frac{Q}{\pi} \right)^n \int_0^L \left(\frac{1}{I_{R(z)}} \right)^n dz \quad \dots(17)$$

Resistance to flow λ is defined as the ratio of pressure drop to the volumetric flow rate or flux. i.e.,

$$\lambda = \frac{\Delta p}{Q} \quad \dots(18)$$

Using equation (17), it can be written as

$$\lambda = 2\mu_0 \frac{Q^{n-1}}{\pi^n} \int_0^L \left(\frac{1}{I_{R(z)}} \right)^n dz \quad \dots(19)$$

For non-stenotic region, i.e. ($R(z) = R_0$), resistance to flow is given by

$$\lambda_N = 2\mu_0 \frac{Q^{n-1}}{\pi^n} \int_0^l \left(\frac{1}{I_{R_0}}\right)^n dz \quad \dots(20)$$

$$\text{Where } I_{R_0} = \int_0^{R_0} r^2 \left\{ \frac{r - \frac{2\tau_0}{\frac{\partial p}{\partial z}}}{(1 - q \frac{r}{R_0})} \right\}^{1/n} dr \quad \dots(21)$$

So, the ratio of resistance to flow is obtained by

$$\lambda' = \frac{\lambda}{\lambda_N} \quad \dots(22)$$

i.e., from equations (19) and (20), we have

$$\lambda' = \frac{\int_0^l \left(\frac{1}{I_{R(z)}}\right)^n dz}{\int_0^l \left(\frac{1}{I_{R_0}}\right)^n dz} \quad \dots(23)$$

The **wall shear stress** is given by

$$\tau_w = \mu(r) \left(-\frac{\partial u}{\partial r}\right)^n + \tau_0 \Big|_{r=R(z)} \quad \dots(24)$$

Using equations (10) and (24), we have

$$\tau_w = R(z)\mu_0 \left(\frac{Q}{\pi I_{R(z)}}\right)^n \quad \dots(25)$$

Now, at maximum stenosis height, the wall shear stress from equation (25) is given as

$$\tau_{wl} = R(z)\mu_0 \left(\frac{Q}{\pi I_{R(z)}}\right)^n \Big|_{z=d+\frac{l_0}{2}} \quad \dots(26)$$

The wall shear stress for normal artery is given as

$$\tau_{Nl} = R_0\mu_0 \left(\frac{Q}{\pi I_{R_0}}\right)^n \quad \dots(27)$$

At the wall, the ratio of shearing stresses is

$$\tau' = \frac{\tau_{wl}}{\tau_{Nl}} \quad \dots(28)$$

i.e., from equations (26) and (27)

$$\tau' = \frac{R(z) \left(\frac{1}{I_{R(z)}}\right)^n \Big|_{z=d+\frac{l_0}{2}}}{R_0 \left(\frac{1}{I_{R_0}}\right)^n} \quad \dots(29)$$

IV. RESULTS AND DISCUSSION

The analytical expressions for volumetric flow rate, resistance to flow and the wall shear stress have been derived in the previous section.

The profile of Q given by equation (12) with axial distance to radius ratio $\frac{z}{R_0}$ for linearly radial variation of viscosity of fluid are plotted in Figs. 2 – 5, respectively, for distinct values of q , n , pressure gradient (p) and yield stress (τ_0). It can be easily seen from Fig. 2 that flow rate Q increases as q increases for fixed values of n and $\frac{z}{R_0}$. In Fig. 3, flow rate Q increases more rapidly for $n=1$ (Newtonian) in comparison to $n=2/3$ or $1/3$ (Non-Newtonian) for fixed values of $\frac{z}{R_0}$. Furthermore, from Figs. 4 and 5 it has been observed that the flow rate Q becomes higher for increasing values of pressure gradients and becomes lower for increasing values of yield stress.

The profile of Q given by equation (12), λ' given by equation (23) and τ' given by equation (29) with stenosis height to radius ratio $\frac{\delta}{R_0}$ for linearly radial variation of viscosity of fluid are plotted in Figs. 6 – 17, respectively, for distinct values of q , n , pressure gradient (p) and yield stress (τ_0).

It is clear from the Figs. 6, 10 and 14 that Q, λ', τ' increases as q increases for fixed values of n and $\frac{\delta}{R_0}$. In Figs. 11 and 15, λ' and τ' increases more rapidly for $n=1$ (Newtonian) in comparison to $n=2/3$ or $n=1/3$ (Non-Newtonian) whereas in Fig. 7 Q decreases more rapidly for $n=1$ (Newtonian) in comparison to $n=2/3$ or $1/3$ (Non-Newtonian).

It can be noted from Figs. 12 and 16 that λ' and τ' increases as pressure gradient decreases for fixed value of $\frac{\delta}{R_0}$. Also from Fig. 8, flow rate Q becomes higher for increasing values of pressure gradient and decreases more rapidly for high values of pressure gradient as $\frac{\delta}{R_0}$ increases.

Furthermore, from Figs. 13 and 17, λ' and τ' increases as yield stress increases for fixed values

of $\frac{\delta}{R_0}$. They both increases more rapidly for $\tau_0 = 0.05$ in comparison to $\tau_0 = 0$ or $\tau_0 = 0.02$ as $\frac{\delta}{R_0}$ increases. Also from Fig. 9, flow rate Q becomes higher for decreasing values of yield stress and decreases more rapidly for low values of yield stress as $\frac{\delta}{R_0}$ increases.

Finally, it can noted from Figs. 6 – 17 that λ' and τ' increases whereas Q decreases as $\frac{\delta}{R_0}$ increases.

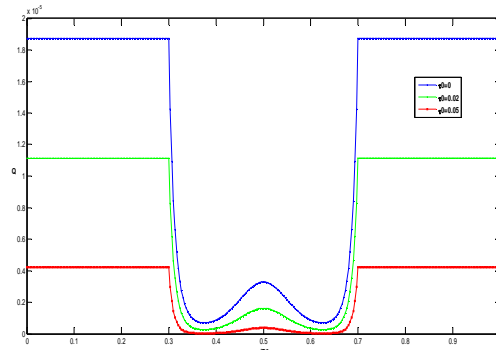


Fig. 5 : Profiles for Q against $\frac{z}{R_0}$ for distinct τ_0

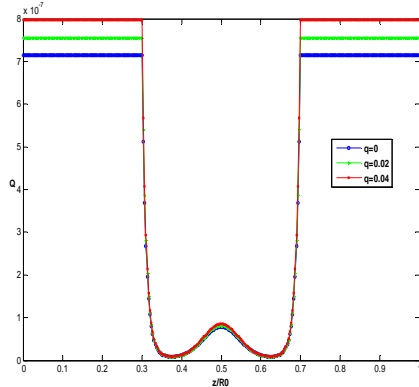


Fig. 2 : Profiles for Q against $\frac{z}{R_0}$ for distinct q

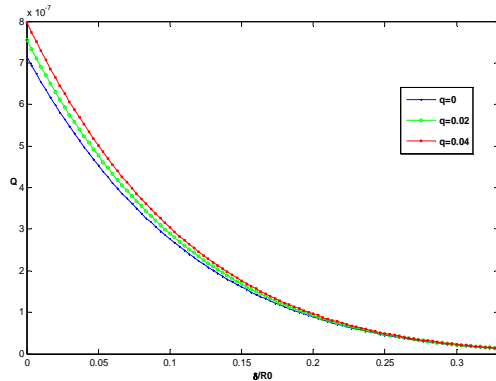


Fig. 6 : Profiles for Q against $\frac{\delta}{R_0}$ for distinct q

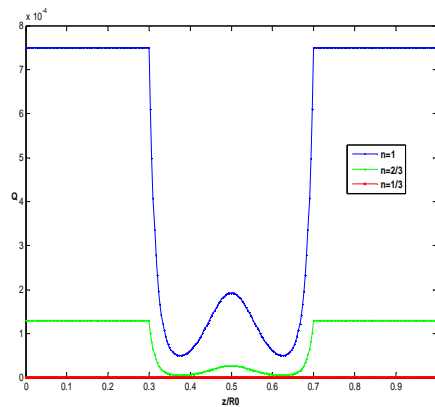


Fig. 3 : Profiles for Q against $\frac{z}{R_0}$ for distinct n

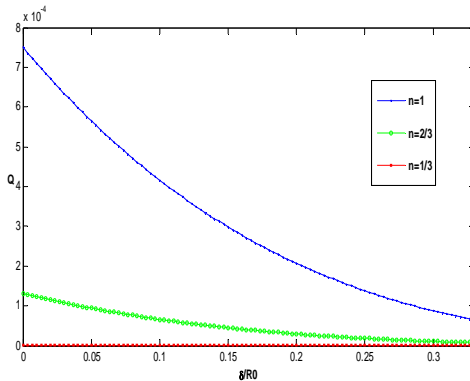


Fig. 7 : Profiles for Q against $\frac{\delta}{R_0}$ for distinct n

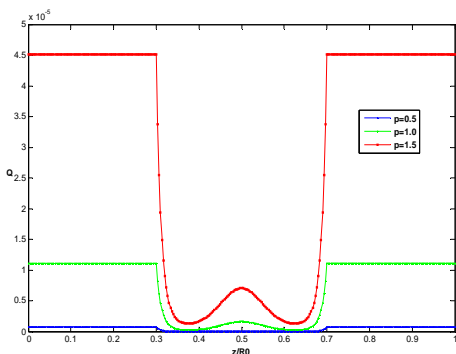


Fig. 4 : Profiles for Q against $\frac{z}{R_0}$ for distinct p

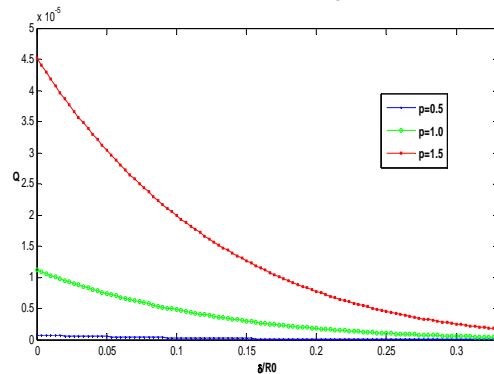


Fig. 8 : Profiles for Q against $\frac{\delta}{R_0}$ for distinct p

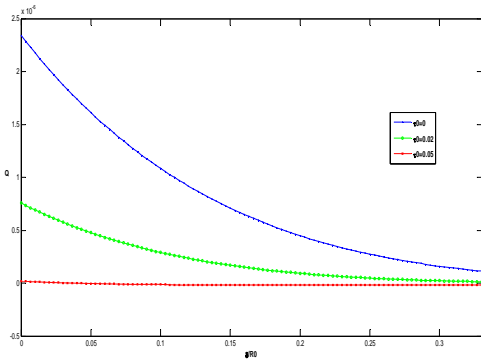


Fig. 9 : Profiles for Q against $\frac{\delta}{R_0}$ for distinct τ_0

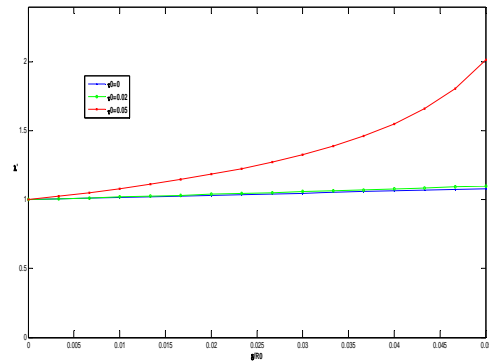


Fig. 13 : Profiles for λ' against $\frac{\delta}{R_0}$ for distinct τ_0

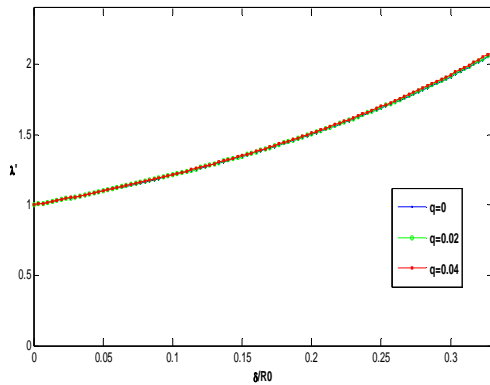


Fig. 10 : Profiles for λ' against $\frac{\delta}{R_0}$ for distinct q

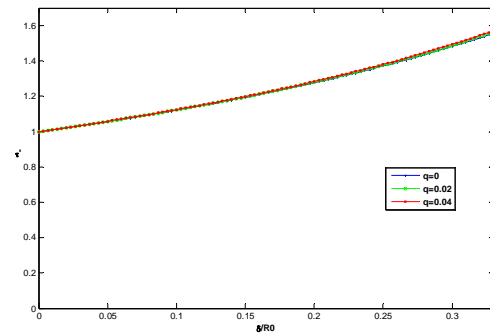


Fig. 14 : Profiles for τ' against $\frac{\delta}{R_0}$ for distinct q

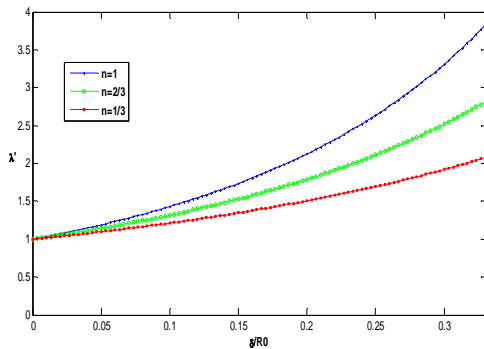


Fig. 11 : Profiles for λ' against $\frac{\delta}{R_0}$ for distinct n

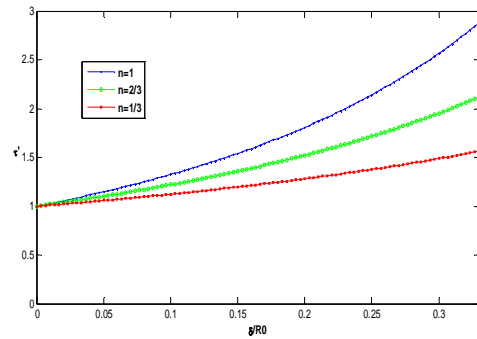


Fig. 15 : Profiles for τ' against $\frac{\delta}{R_0}$ for distinct n

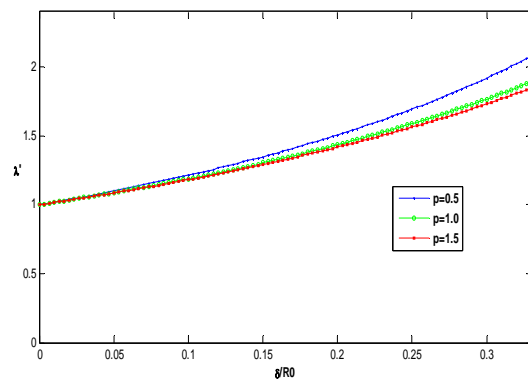


Fig. 12 : Profiles for λ' against $\frac{\delta}{R_0}$ for distinct p

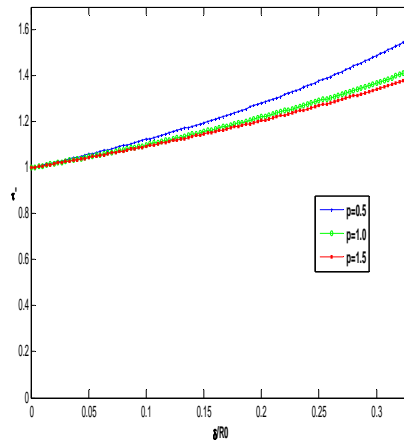


Fig. 16 : Profiles for τ' against $\frac{\delta}{R_0}$ for distinct p

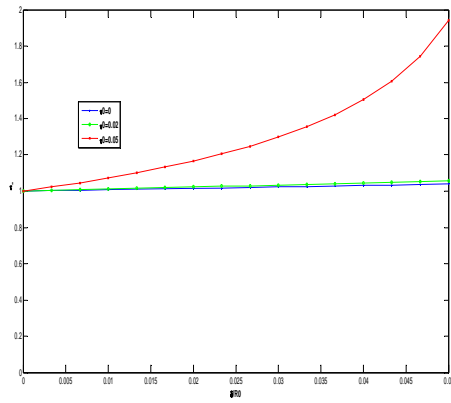


Fig. 17 : Profiles for τ' against $\frac{\delta}{R_0}$ for distinct τ_0

V. CONCLUSION

The analytical expression for the flow rate, resistance to flow and wall shear stress is obtained and results are discusses graphically. It is found that flow rate decreases as the height of stenosis is increased. Furthermore, resistance to flow and wall shear stress increases as the height of stenosis is increased. Flow rate of the fluid first decreases as the axial distance increases and then it increases with the value of axial distance and attains its minimum value when stenosis size is maximum within the stenosis region. This study may lead to some important results for clinical point of view.

REFERENCES

[1] Blair, G.W.S., Spanner, D.C.,1974, An Introduction to Biorheology. Elsevier., Amsterdam.
 [2] Chakravarthy S., Mandal P.K., 1994, Mathematical Modelling of blood flow through an overlapping stenosis, Mathematical Computational Modelling ,Vol.19, pp. 59-73.
 [3] Charm S.E., and Kurland G.S., 1965, Viscometry of human blood for shear rate of 100,000 sec⁻¹, Nature London 206, pp. 617-618.
 [4] Chaturani P., PonnalagarSamy R.,1985, A study of non-Newtonian aspects of blood flow through stenosed arteries and its applications in arterial diseases, Biorheology, Vol. 22, Issue 6, pp. 521-531.
 [5] Cokelet G.R.,1972, "The rheology of human blood", Biomechanics, Ed. By Y. C. Fung et al., 63, Englewood Cliffs: Prentice-Hall.

[6] Gupta S., Gupta M., Singh S.P., 2011, Effect of radial viscosity on Non-Newtonian flow of blood in a stenosed artery, International Journal of Applied Mathematics and Mechanics, Vol. 8, Issue 2, pp. 55-61.
 [7] Jain N., Singh S.P., Gupta M., 2012, Steady flow of blood through an Artherosclerotic artery: A Non-Newtonian fluid model, International Journal of Applied Mathematics and Mechanics, Vol. 8, Issue 18, pp. 52-63.
 [8] Layek, Mukhopadhya, G.C., and Glora, R.S.D., 2009, Unsteady viscous flow with various viscosity in a vascular tube with an overlapping constriction, International Journal of Engineering Science, Vol. 47, pp. 649-659.
 [9] Misra J.C., Shit G.C., 2005, Blood flow through arteries in a thological state: A Theoretical Study, International Journal of Engineering Science, Vol. 44, pp. 662-671.
 [10] Nallapu S., Radhakrishnamacharya G., 2014, Herschel-Bulkley fluid flow through narrow tubes, Central European Journal of Physics, pp. 1-12.
 [11] Shah S.R., 2013, An innovative study for Non-Newtonian behavior f blood flow in stenosed artery using Herschel-Bulkley fluid model, International Journal of Bio-Science and Bio-Technology, Vol. 5, Issue 5, pp. 233-240.
 [12] Srivastava, V. P., Rastogi, Rati and Vishnoi, Rochana. (2010). A two-layered suspension blood flow through an overlapping stenosis. Comput. and Math. with Applc., In press.
 [13] Shukla JB, Parihar RS, and Gupta SP (1980a). Effects of peripheral layer viscosity on blood flow through the artery with mild stenosis, Bulletin of Mathematical Biology 42, pp. 797-805.
 [14] Shukla J.B., Parihar R.S., and Gupta S.P.,(1980b), Effects of peripheral layer viscosity on blood flow through the artery with mild stenosis, Bulletin of Mathematical Biology 42, pp. 283-294.
 [15] Young, D.F.,1968, Effects of a time-dependent stenosis on flow through a tube, Journal of Engineering for Industry, Vol. 90, Issue 1, pp. 248-254.